



**CRYSTAL UNITS IN METAL HOLDER,
BASED ON TYPE T1507,
FREQUENCY RANGE 2.5 - 50MHZ**

ESCC Detail Specification No. 3501/009

(Follow-up Specification to ESA/SCC Detail Specification No. 3501/002)

**ISSUE 2
April 2007**



	ESCC Detail Specification No. 3501/009		PAGE ii ISSUE 2
--	---	--	--------------------

LEGAL DISCLAIMER AND COPYRIGHT

European Space Agency, Copyright © 2007. All rights reserved.

The European Space Agency disclaims any liability or responsibility, to any person or entity, with respect to any loss or damage caused, or alleged to be caused, directly or indirectly by the use and application of this ESCC publication.

This publication, without the prior permission of the European Space Agency and provided that it is not used for a commercial purpose, may be:

- copied in whole in any medium without alteration or modification.
- copied in part, in any medium, provided that the ESCC document identification, comprising the ESCC symbol, document number and document issue, is removed.



ESCC Detail Specification
No. 3501/009

PAGE 2

ISSUE 2

DOCUMENTATION CHANGE NOTICE

(Refer to <https://escies.org> for ESCC DCR content)

DCR No.	CHANGE DESCRIPTION
261, 290	<p>Specification upissued to incorporate technical and editorial changes per DCRs.</p> <p>For operational reasons, only the affected pages have the correct issue number and ESCC logo. These are cover page, legal disclaimer, DCN, Table of contents and Appendix. The remainder of the specification is the ESA/SCC version.</p>



	<p style="text-align: center;">ESA/SCC Detail Specification No. 3501/009</p>		<p>PAGE 3 ISSUE 2</p>
--	--	--	---------------------------

TABLE OF CONTENTS

		<u>Page</u>
1.	<u>GENERAL</u>	5
1.1	Scope	5
1.2	Component Type Variants	5
1.3	Maximum Ratings	5
1.4	Physical Dimensions	5
1.5	Functional Diagram	5
2.	<u>APPLICABLE DOCUMENTS</u>	14
3.	<u>TERMS, DEFINITIONS, ABBREVIATIONS, SYMBOLS AND UNITS</u>	14
4.	<u>REQUIREMENTS</u>	14
4.1	General	14
4.2	Deviations from Generic Specification	14
4.2.1	Deviations from Special In-process Controls	14
4.2.2	Deviations from Final Production Tests	14
4.2.3	Deviations from Burn-in Tests	14
4.2.4	Deviations from Qualification Tests	14
4.2.5	Deviations from Lot Acceptance Tests	14
4.3	Mechanical Requirements	15
4.3.1	Dimension Check	15
4.3.2	Weight	15
4.3.3	Robustness of Terminations	15
4.4	Materials and Finishes	15
4.4.1	Case	15
4.4.2	Lead Material and Finish	15
4.5	Marking	15
4.5.1	General	15
4.5.2	The SCC Component Number	15
4.5.3	Characteristics	16
4.5.4	Traceability Information	16
4.5.5	Manufacturer's Name, Symbol or Code	16
4.6	Electrical Measurements	16
4.6.1	Electrical Measurements at Reference Temperature	16
4.6.2	Electrical Measurements at High and Low Temperatures	16
4.6.3	Circuits for Electrical Measurements	16
4.7	Burn-in Tests	16
4.7.1	Parameter Drift Values	16
4.7.2	Conditions for Burn-in	16
4.7.3	Electrical Circuits for Burn-in	16
4.8	Environmental and Endurance Tests	19
4.8.1	Measurements and Inspections on Completion of Environmental Tests	19
4.8.2	Measurements and Inspections at Intermediate Points and on Completion of Endurance Tests	19
4.8.3	Conditions for Operating Life Test	19

	<p style="text-align: center;">ESA/SCC Detail Specification No. 3501/009</p>		<p>PAGE 4 ISSUE 2</p>
---	--	--	---------------------------

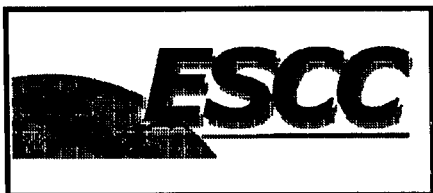
TABLES

		<u>Page</u>
1(a)	Type Variant Summary	6
	Type Variant Detailed Information	23
1(b)	Maximum Ratings	9
1(c)	Format for Individual Tables 1(a)	10
2	Electrical Measurements at Reference Temperature	17
3	Electrical Measurements at High and Low Temperatures	18
4	Parameter Drift Values	18
5	Conditions for Burn-in and Life Test	18
6	Measurements and Inspections on Completion of Environmental Tests and at Intermediate Points and on Completion of Endurance Testing	20

FIGURES

1	Parameter Derating Information	N/A
2	Physical Dimensions	13
3	Functional Diagram	13
4	Circuits for Electrical Measurements	N/A
5	Electrical Circuit for Burn-in and Life Test	N/A

APPENDICES (Applicable to specific Manufacturers only)

A	C-MAC Frequency Products (F)	58
---	------------------------------	----



europaean space agency
agence spatiale européenne

Pages 1 to 57

**CRYSTAL UNITS IN METAL HOLDER,
BASED ON TYPE T1507,
FREQUENCY RANGE 2.5 - 50MHZ**

ESA/SCC Detail Specification No. 3501/009

(Follow-up Specification to ESA/SCC Detail Specification No. 3501/002)



**space components
coordination group**

Issue/Rev.	Date	Approved by	
		SCCG Chairman	ESA Director General or his Deputy
Issue 2	October 1998		
Revision 'A'	April 1999		
Revision 'B'	May 2000		
Revision 'C'	June 2001		



DOCUMENTATION CHANGE NOTICE

Rev. Letter	Rev. Date	Reference	CHANGE Item	Approved DCR No.
		This Issue supersedes Issue 1 and incorporates all modifications defined in Revisions 'A', 'B' and 'C' to Issue 1 and the changes agreed in the following DCRs:-		
		Cover Page		None
		DCN		None
		Table 1(a)	: Storage Temperature Range column deleted : Figure column deleted : Variant 03, "(2)" added to Frequency column : Variants 08 to 28 added : Note 2 added	221336 221337 221497 221497 221497
		Table 1(b)	: No. 4, in Remarks, Note number amended : No. 5, in Remarks, Note number amended : New Note 3 added	221336 221336 221336
		Table 1(c)	: Existing Note 3 renumbered as "4" : Item 19 deleted : Item 20 deleted and subsequent items renumbered : In old Item 22, Note number amended to "15" : Note 14 deleted and subsequent Notes renumbered	221336 221337 221336 221337 221337
		Figure 2(a)	: Figure deleted in toto	221337
		Figure 2(b)	: Subtitle deleted : Drawing and Table amended : Vibration Axes and Notes added	221381 221381 221381
		Para. 4.3.3	: Second sentence amended	221341
		Para. 4.5.1	: Existing text deleted and new text added	221465
		Para. 4.5.5	: Deleted in toto	221465
		Para. 4.5.6	: Renumbered to "4.5.5"	221465
		Para. 4.6.1	: Second sentence rewritten	221341
		Table 6	: Table reformatted	23799/ 221341/ 221380/ 221465
		Ind. Tables 1(a)	: Item 19 deleted : Variant 01, Item 20 deleted and Item 21 renumbered as "19" : Variants 02 to 07, Item 20 deleted and subsequent Items renumbered : Variants 08 to 28, Tables added	221337 221336 221336 221497
'A'	Apr. '99	P1. Cover Page	: Frequency Range amended in Title	21115
		P2. DCN		None
		P5. Para. 1.1	: Frequency Range amended in first sentence	21115
		P6. Table 1(a)	: Variants 03 and 09, "(2)" deleted from Frequency column	21115
		P8. Table 1(a)	: Note 2 deleted	21115
		P38. Table 1(a)	: Variant 16, No. 13 Limit moved to Min. column	23904
		P40. Table 1(a)	: Variant 18, No. 16 Max. Limit deleted	23903
'B'	May '00	P1. Cover Page		None
		P2. DCN		None
		P13. Figure 2	: In the Table, dimension 'C' max. amended	221548

**SCC**ESA/SCC Detail Specification
No. 3501/009

Rev. 'C'

PAGE 2A

ISSUE 2

DOCUMENTATION CHANGE NOTICE

Rev. Letter	Rev. Date	Reference	CHANGE Item	Approved DCR No.
'C'	Jun. '01	P1. Cover page P2A. DCN P6. Table 1(a) P51. to P57.	: Page count incremented by 7 : Page added : Variants 29 to 35 added : New pages for Variants 29 to 35 added	221605 None 221605 221605



TABLE OF CONTENTS

	<u>Page</u>
1. <u>GENERAL</u>	5
1.1 Scope	5
1.2 Component Type Variants	5
1.3 Maximum Ratings	5
1.4 Physical Dimensions	5
1.5 Functional Diagram	5
2. <u>APPLICABLE DOCUMENTS</u>	14
3. <u>TERMS, DEFINITIONS, ABBREVIATIONS, SYMBOLS AND UNITS</u>	14
4. <u>REQUIREMENTS</u>	14
4.1 General	14
4.2 Deviations from Generic Specification	14
4.2.1 Deviations from Special In-process Controls	14
4.2.2 Deviations from Final Production Tests	14
4.2.3 Deviations from Burn-in Tests	14
4.2.4 Deviations from Qualification Tests	14
4.2.5 Deviations from Lot Acceptance Tests	14
4.3 Mechanical Requirements	15
4.3.1 Dimension Check	15
4.3.2 Weight	15
4.3.3 Robustness of Terminations	15
4.4 Materials and Finishes	15
4.4.1 Case	15
4.4.2 Lead Material and Finish	15
4.5 Marking	15
4.5.1 General	15
4.5.2 The SCC Component Number	15
4.5.3 Characteristics	16
4.5.4 Traceability Information	16
4.5.5 Manufacturer's Name, Symbol or Code	16
4.6 Electrical Measurements	16
4.6.1 Electrical Measurements at Reference Temperature	16
4.6.2 Electrical Measurements at High and Low Temperatures	16
4.6.3 Circuits for Electrical Measurements	16
4.7 Burn-in Tests	16
4.7.1 Parameter Drift Values	16
4.7.2 Conditions for Burn-in	16
4.7.3 Electrical Circuits for Burn-in	16
4.8 Environmental and Endurance Tests	19
4.8.1 Measurements and Inspections on Completion of Environmental Tests	19
4.8.2 Measurements and Inspections at Intermediate Points and on Completion of Endurance Tests	19
4.8.3 Conditions for Operating Life Test	19



TABLES



	<u>Page</u>
1(a) Type Variant Summary	6
Type Variant Detailed Information	23
1(b) Maximum Ratings	9
1(c) Format for Individual Tables 1(a)	10
2 Electrical Measurements at Reference Temperature	17
3 Electrical Measurements at High and Low Temperatures	18
4 Parameter Drift Values	18
5 Conditions for Burn-in and Life Test	18
6 Measurements and Inspections on Completion of Environmental Tests and at Intermediate Points and on Completion of Endurance Testing	20

FIGURES

1 Parameter Derating Information	N/A
2 Physical Dimensions	13
3 Functional Diagram	13
4 Circuits for Electrical Measurements	N/A
5 Electrical Circuit for Burn-in and Life Test	N/A

APPENDICES (Applicable to specific Manufacturers only)

None.

		<p style="text-align: center;">ESA/SCC Detail Specification No. 3501/009</p>	<p style="text-align: center;">Rev. 'A'</p>	<p>PAGE 5 ISSUE 2</p>
--	--	--	---	---------------------------

1. GENERAL

1.1 SCOPE

This specification details the values, physical and electrical characteristics, test and inspection data for Crystal Units in Metal Holder, based on Type T1507, Frequency Range 2.5 - 50MHz.

It shall be read in conjunction with ESA/SCC Generic Specification No. 3501, the requirements for which are supplemented herein.

This is a follow-up specification to ESA/SCC Detail Specification No. 3501/002. ESA/SCC 3501/002 should also be consulted by:-

- (a) Users seeking information concerning the availability of variants additional to those listed in this specification.
- (b) Manufacturers before requesting the introduction of a new variant in accordance with the requirements of Para. 1.2 of this specification.

1.2 COMPONENT TYPE VARIANTS

A list of the type variants of the crystal units specified herein, which are also covered by this specification, is given in "Table 1(a) - Type Variant Summary".

For each type variant, the full electrical and physical characteristics are given in individual Tables 1(a) - "Type Variant Detailed Information" at the end of this specification.

The contents of the individual Tables 1(a) shall be as shown in Table 1(c) and the characteristics therein listed shall relate to the design parameters of the individual crystal units, optimised for the intended application.

The specific characteristics shall be negotiated between the Manufacturer and the Orderer. The Manufacturer shall then apply to the ESA/SCC Secretariat for a type variant number for each individual crystal unit concerned, by sending a finalised Table 1(a) which shall also be copied to the Qualifying Space Agency (QSA).

1.3 MAXIMUM RATINGS

The maximum ratings, which shall not be exceeded at any time during use or storage, applicable to the crystal units specified herein, are as scheduled in Table 1(b).

1.4 PHYSICAL DIMENSIONS

The physical dimensions of the crystal units specified herein are shown in Figure 2.

1.5 FUNCTIONAL DIAGRAM

The functional diagram showing lead identification of the crystal units specified herein is shown in Figure 3.

**TABLE 1(a) - TYPE VARIANT SUMMARY****N.B.** For additional information concerning type variants, see Para. 1.1.

Variant	Resonance Frequency (MHz)	Load Capacitance (C _L pF)	Reference Temp. (T ₀ °C)	Operating Temp. Range (T _{op} °C)	Intended Application	Lead Finish
01	4.194304	30	+30	- 10 to +80	-	2
02	8.192	50	+25	-25 to +80	-	3 or 4
03	26.0	∞	+25	-25 to +80	-	2
04	7.198	30	+25	-55 to +105	-	2
05	5.0	30	+25	-40 to +80	-	2
06	18.0	30	+25	-45 to +80	-	2
07	10.0	30	+25	-55 to +125	-	2
08	10.0	30	+25	-55 to +100	XO	2
09	50.0	12	+25	-20 to +80	VCXO	2
10	4.0	30	+25	-40 to +80	XO	2
11	10.0	30	+25	-55 to +100	XO	2
12	8.0	∞	+25	-20 to +80	XO	2
13	10.0	∞	+25	-20 to +80	TCXO	2
14	6.4	30	+25	-45 to +80	XO	4
15	12.605	∞	+25	-20 to +60	TCXO	2
16	7.0	30	+25	-35 to +70	TCXO	2
17	12.665	∞	+25	-20 to +80	TCXO	2
18	5.760	30	+25	-40 to +90	XO	2
19	8.602893	30	+60	-40 to +85	XO	2
20	15.104893	∞	+25	-20 to +80	XO	2
21	20.0	30	+25	-30 to +70	XO	2
22	13.0	30	+25	-40 to +80	XO	2
23	10.0	30	+25	-55 to +100	XO	2
24	5.242880	30	+60	-40 to +85	XO	2
25	5.625	30	+25	-40 to +85	XO	2
26	11.250	30	+25	-50 to +100	XO	2
27	8.0	∞	+25	-30 to +70	XO	2
28	3.494400	35	+25	-55 to +100	XO	2
29	3.832	30	+25	-40 to +80	XO	2
30	3.072	30	+25	-40 to +80	XO	2
31	4.0	30	+25	-40 to +80	XO	2
32	16.0	30	+25	-55 to +125	XO	2
33	11.059200	30	+25	-55 to +100	XO	2
34	12.007125	30	+25	-40 to +90	TCXO	2
35	11.059300	50	+25	-55 to +100	XO	2
36						

NOTES: See Page 8.



TABLE 1(a) - TYPE VARIANT SUMMARY CONTINUED

Variant	Resonance Frequency (MHz)	Load Capacitance (C _L pF)	Reference Temp. (T _o °C)	Operating Temp. Range (T _{op} °C)	Intended Application	Lead Finish
37						
38						
39						
40						
41						
42						
43						
44						
45						
46						
47						
48						
49						
50						
51						
52						
53						
54						
55						
56						
57						
58						
59						
60						
61						
62						
63						
64						
65						
66						
67						
68						
69						
70						
71						
72						

NOTES: See Page 8.



TABLE 1(a) - TYPE VARIANT SUMMARY CONTINUED

Variant	Resonance Frequency (MHz)	Load Capacitance (C _L pF)	Reference Temp. (T ₀ °C)	Operating Temp. Range (T _{op} °C)	Intended Applicat.	Lead Finish
73						
74						
75						
76						
77						
78						
79						
80						
81						
82						
83						
84						
85						
86						
87						
88						
89						
90						
91						
92						
93						
94						
95						
96						
97						
98						
99						

NOTES

1. Full electrical and physical characteristics are given in the individual Tables 1(a) at the end of this specification.

**TABLE 1(b) - MAXIMUM RATINGS**

No.	Characteristic	Symbol	Values	Unit	Remarks
1	Nominal Frequency Range	f	2.5 to 20	MHz	Note 1
2	Drive Level Range	P	0.01 to 0.2	mW	
3	Operating Temperature Range	T _{op}	-	°C	Note 2
4	Storage Temperature Range	T _{stg}	-65 to +125	°C	Note 3
5	Soldering Temperature	T _{sol}	+260	°C	Note 4

NOTES

1.

Fundamental and Overtone Order	Approx. Frequency Range (MHz)
Fundamental	2.5 to 20
3	10 to 30
5	15 to 50

2. See Table 1(a).

3. The duration at maximum storage temperature shall not exceed 16 hours.

4. Duration 10 seconds maximum at a distance of not less than 3.0mm from the device body and the same lead shall not be resoldered until 3 minutes have elapsed.



TABLE 1(c) - FORMAT FOR INDIVIDUAL TABLES 1(a)

TABLE 1(a) - TYPE VARIANT DETAILED INFORMATION

TYPE VARIANT NO. _____

No.	Characteristic	Symbol	Limits		Unit	Remarks
			Min.	Max		
1	Resonance Frequency	f_r or f_L			MHz	Note 1
2	Reference Temperature	T_o			°C	Note 2
3	Overtone Order	-				
4	Load Capacitance	C_L			pF	Note 3
5	Rated Drive Level	P_o			mW	Note 4
6	Frequency Adjustment Tolerance	$\frac{\Delta f}{f}$			10^{-6}	At T_o °C Note 5
7	Resonance Resistance	R_r or R_L			Ω	At T_o °C Note 6
8	Frequency Variation with Temperature over T_{op}	$\frac{\Delta f}{f}$			10^{-9}	From frequency measured at T_o °C Note 7
9	Resistance Variation with Temperature over T_{op}	$\frac{\Delta R}{R}$			%	From resistance measured at T_o °C Note 7
10	Operating Temperature Range	T_{op}			°C	
11	Frequency variation with Drive Level	$\frac{\Delta f}{f}$			10^{-6}	From $P_{S1} =$ mW to $P_{S2} =$ mW Note 8
12	Resistance variation with Drive Level	$\frac{\Delta R}{R}$			%	From $P_{S1} =$ mW to $P_{S2} =$ mW Note 8
13	Motional Inductance	L_1			mH	Notes 9 and 10
14	Motional Capacitance	C_1			fF	Note 9
15	Static Capacitance	C_o			pF	Note 9
16	Q Factor	Q			-	Notes 9 and 11
17	Ratio of unwanted: Response Resistance to Resonance Resistance or Response Impedance to Resonance Resistance	R_p/R or $I Z_p/R$				In the frequency range: f - kHz to f + kHz
18	Ageing	$\frac{\Delta f}{f}$			10^{-6}	Note 13
19	Lead Finish	-				
20	Intended Application					Note 15

NOTES: See Pages 11 and 12.

**NOTES TO TABLE 1(c)**

1. (a) If C_L is not specified, Symbol and measurement shall be f_r .
(b) If C_L is specified, Symbol and measurement shall be f_L .
2. Reference Temperature T_0
 - (a) For a crystal unit functioning in a non-controlled temperature environment, the reference temperature is normally $+25 \pm 2$ °C.
 - (b) For a crystal unit functioning in a controlled temperature environment, the reference temperature shall normally be the mid-point of the temperature range of the controlled environment.
3. Load Capacitance C_L
 - (a) When a crystal unit must function at its series resonance frequency, C_L shall be infinite.
 - (b) When a crystal must function with a load capacitance, the C_L value shall be specified. The standard values of load capacitance are as follows:
 - Fundamental Frequency Operation: 20pF, 30pF, 50pF and 100pF.
 - Overtone Operation: 8pF, 12pF, 15pF, 20pF and 30pF.

N.B

The tolerance on the load capacitance shall be that value which results in a frequency change not exceeding 10% of the frequency tolerance at T_0 or 1% of the nominal load capacitance, whichever is smaller.

4. Rated Drive Level P_0

The rated drive level shall be selected from the standard drive levels specified below:

 - Preferred values: 2mW, 1mW, 0.5mW, 0.2mW, 0.1mW, 0.05mW, 0.02mW, 0.01mW, 0.001mW or 0.0001mW at $\pm 20\%$.
 - Non-preferred values: 10mW, 5mW and 4mW all at $\pm 20\%$.
5. Frequency Adjustment Tolerance
 - (a) When a crystal must function at its series resonance frequency, the standard value of the adjustment tolerance shall be $\pm 10 \times 10^{-6}$.
 - (b) When a crystal has to function with a load capacitance, the standard value of the adjustment tolerance shall also be $\pm 10 \times 10^{-6}$. However, if the load capacitance is adjustable, it is preferable to specify that the nominal frequency be obtained with a load capacitance value between the minimum and maximum value when the crystal is functioning in its fundamental mode.
6. Resonance Resistance
 - (a) Generally, the maximum value only is specified.
 - (b) R_L may be calculated by
$$R_L = R_r \left(1 + \frac{C_0}{C_L} \right)^2 .$$

**NOTES TO TABLE 1(c) (Continued)****7. Frequency and Resistance Variation with Temperature**

These values shall be specified such that they are consistent with the operating temperature range.

8. Frequency and Resistance Variation with Drive Level

These limits and the Drive Level range (P_{S1} to P_{S2}) shall be specified for very special crystals only (i.e. crystals used in very high stability oscillators).

9. Electrical Values

The electrical values shall be specified only when required for the correct functioning of the equipment in which the crystal is used.

10. Motional Inductance L_1

Because the inductance value may be restricted by other chosen parameters, the Manufacturer shall propose the value of L_1 in accordance with the Customer's requirements.

11. 'Q' Factor

If 'R' and 'L' have been already specified, it will not be necessary to specify the minimum value of the 'Q' factor.

The maximum value of the 'Q' factor is never specified.

12. Ratio of Unwanted Response Resistance to Resonance Resistance

The standard minimum value is 2, but it is possible to obtain higher values.

The frequency range within which the minimum value of the ratio is required shall also be specified.

13. Ageing

Specify limits under appropriate column and ageing period under "Remarks".

14. Not applicable Items

For all items where limits are not specified, "Not applicable" shall be entered in the Limits column.

15. Intended Application

For definitions of the selected symbols to be added, see ESA/SCC Generic Specification No. 3501, Para. 3.

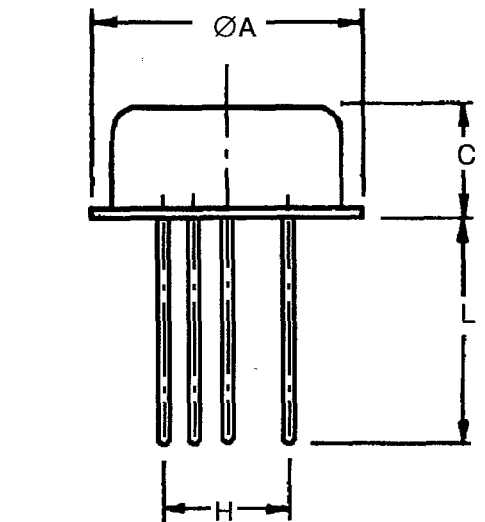

FIGURE 1 - PARAMETER DERATING INFORMATION

Not applicable.

FIGURE 2 - PHYSICAL DIMENSIONS

SYMBOL	MILLIMETRES		REMARKS
	MIN.	MAX.	
ØA	-	15.75	
C	-	6.80	
H	6.90	7.40	Pitch 7.16mm
ØK	0.40	0.48	
L	12.70	-	
P	-	0.90	Note 2
Q	-	0.95	Note 2



NOTES

1. Lead No. 5 is grounded to case.
2. The tag's position or presence is optional.

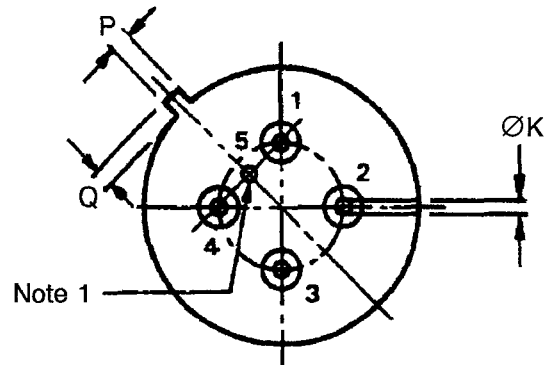
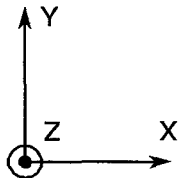
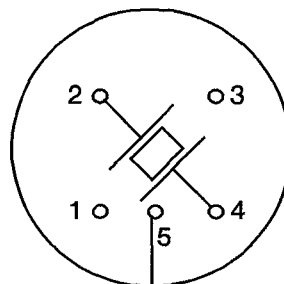

FIGURE 3 - FUNCTIONAL DIAGRAM



(BOTTOM VIEW)

**2. APPLICABLE DOCUMENTS**

The following documents form part of this specification and shall be read in conjunction with it:-

(a) ESA/SCC Generic Specification No. 3501 for Quartz Crystal Units.

3. TERMS, DEFINITIONS, ABBREVIATIONS, SYMBOLS AND UNITS

For the purpose of this specification, the terms, definitions, abbreviations, symbols and units specified in ESA/SCC Basic Specification No. 21300 shall apply. In addition, the following symbols are used:-

Resonance Frequency	= f_r
Load Resonance Frequency	= f_L
Reference Temperature	= T_o
Resonance Resistance	= R_r
Load Resonance Resistance	= R_L
Rated Drive Level	= P_o
Static Capacitance	= C_o
Load Capacitance	= C_L
Motional Capacitance	= C_1
Motional Inductance	= L_1
Response Resistance	= R_p
Response Impedance	= $ Z_p $
Insulation Resistance	= R_i

4. REQUIREMENTS**4.1 GENERAL**

The complete requirements for procurement of the crystal units specified herein shall be as stated in this specification and ESA/SCC Generic Specification No. 3501 for Quartz Crystal Units. Deviations from the Generic Specification applicable to this specification only, are detailed in Para. 4.2.

Deviations from the applicable Generic Specification and this Detail Specification, formally agreed with specific Manufacturers on the basis that the alternative requirements are equivalent to the ESA/SCC requirements and do not affect the components' reliability, are listed in the appendices attached to this specification.

4.2 DEVIATIONS FROM GENERIC SPECIFICATION**4.2.1 Deviations from Special In-process Controls**

None.

4.2.2 Deviations from Final Production Tests (Chart II)

None.

4.2.3 Deviations from Burn-in Tests (Chart III)

None.

4.2.4 Deviations from Qualification Tests (Chart IV)

None.

4.2.5 Deviations from Lot Acceptance Tests (Chart V)

None.



4.3 MECHANICAL REQUIREMENTS

4.3.1 Dimension Check

The dimensions of the crystal units specified herein shall be checked. They shall conform to those shown in Figure 2.

4.3.2 Weight

The maximum weight of the crystal units specified herein shall be 3.0 grammes.

4.3.3 Robustness of Terminations

The requirements for robustness of termination testing are specified in Section 9 of ESA/SCC Generic Specification No. 3501.

4.4 MATERIALS AND FINISHES

The materials and finishes shall be as specified herein. Where a definite material is not specified, a material which will enable the crystal units specified herein to meet the performance requirements of this specification shall be used. Acceptance or approval of any constituent material does not guarantee acceptance of the finished product.

4.4.1 Case

4.4.1.1 Cap

Copper, nickel plated or nickel and gold plated.

4.4.1.2 Base

Kovar, nickel plated or nickel and gold plated.

4.4.2 Lead Material and Finish

The lead material shall be Type 'D' with either Type '2' or Type '3 or 4 ' finish in accordance with the requirements of ESA/SCC Basic Specification No. 23500. (See Tables 1(a) for Type Variants).

4.5 MARKING

4.5.1 General

The marking of all components delivered to this specification shall be in accordance with the requirements of ESA/SCC Basic Specification No. 21700 and the following paragraphs. When the component is too small to accommodate all of the marking specified, as much as space permits shall be marked and the marking information, in full, shall accompany the component in its primary package.

The information to be marked and the order of precedence, shall be as follows:-

- (a) The SCC Component Number.
- (b) Characteristics.
- (c) Traceability Information.

4.5.2 The SCC Component Number

Each component shall bear the SCC Component Number, which shall be constituted and marked as follows:-

350100901B

Detail Specification Number _____

Type Variant (see Table 1(a)) _____

Testing Level (B or C, as applicable) _____



4.5.3 Characteristics

The resonance frequency of the crystal units shall be clearly specified in MHz. Where necessary, it shall be specified to 6 decimal places.

4.5.4 Traceability Information

Each component shall be marked in respect of traceability information in accordance with the requirements of ESA/SCC Basic Specification No. 21700.

4.5.5 Manufacturer's Name, Symbol or Code

The Manufacturer's marking shall be in accordance with the requirements of ESA/SCC Basic Specification No. 21700.

4.6 ELECTRICAL MEASUREMENTS

4.6.1 Electrical Measurements at Reference Temperature

The parameters to be measured in respect of electrical characteristics are scheduled in Table 2. The measurements shall be performed at the temperatures specified in the individual Tables 1(a), Item 2.

4.6.2 Electrical Measurements at High and Low Temperatures

The parameters to be measured at high and low temperatures are scheduled in Table 3. These measurements shall only be performed if values are specified in Table 1(a) Items 8 and/or 9.

4.6.3 Circuits for Electrical Measurements (Figure 4)

Not applicable.

4.7 BURN-IN TESTS

4.7.1 Parameter Drift Values

The parameter drift values applicable to burn-in are specified in Table 4 of this specification. Unless otherwise stated, measurements shall be performed at $T_{amb} = T_o \pm 2 \text{ }^\circ\text{C}$. The parameter drift values (Δ) applicable to the scheduled parameters shall not be exceeded. In addition to these drift value requirements for a given parameter, the appropriate limit value specified in Table 2 shall not be exceeded.

4.7.2 Conditions for Burn-in

The requirements for burn-in are specified in Section 7 of ESA/SCC Generic Specification No. 3501. The conditions for burn-in shall be as specified in Table 5 of this specification.

4.7.3 Electrical Circuits for Burn-in (Figure 5)

Not applicable.

**TABLE 2 - ELECTRICAL MEASUREMENTS AT REFERENCE TEMPERATURE**

No.	Characteristics	Symbol	ESA/SCC 3501 Test Method	Limits	Unit
1	Resonance frequency at reference temperature and rated drive level - with C_O - with C_L	$f_r(T_o, P_o)$ $f_L(T_o, P_o)$	Para. 9.2.1.1	Table 1(a), Item 1 \pm Item 6	MHz
2	Resonance resistance at reference temperature and rated drive level - with C_O - with C_L	$R_r(T_o, P_o)$ $R_L(T_o, P_o)$	Para. 9.2.1.1	Table 1(a), Item 7	Ω
3	Frequency variation with Drive Level	$\frac{\Delta f}{f}(T_o, \Delta P)$	Para. 9.2.1.1	Table 1(a), Item 11	10^{-6}
4	Resistance variation with Drive Level	$\frac{\Delta R}{R}(T_o, \Delta P)$	Para. 9.2.1.1	Table 1(a), Item 12	%
5	Motional Inductance	L_1	Para. 9.2.1.3	Table 1(a), Item 13	mH
6	Static Capacitance	C_o	Para. 9.2.1.4	Table 1(a), Item 15	pF
7	Unwanted response	R_p/R or $ Z_p /R$	Para. 9.2.1.5	Table 1(a), Item 17	-
8	Insulation Resistance	R_i	Para. 9.2.1.6	500 Min.	$M\Omega$

**TABLE 3 - ELECTRICAL MEASUREMENTS AT HIGH AND LOW TEMPERATURES**

No.	Characteristics	Symbol	ESA/SCC 3501 Test Method	Limits	Unit
9	Frequency variation with Temperature over T_{op}	$\frac{\Delta f}{f} (\Delta T, P_0)$	Para. 9.2.1.2	Table 1(a) Item 8	10^{-6}
10	Resistance variation with Temperature over T_{op}	$\frac{\Delta R}{R} (\Delta T, P_0)$	Para. 9.2.1.2	Table 1(a) Item 9	%

FIGURE 4 - CIRCUITS FOR ELECTRICAL MEASUREMENTS

Not applicable.

TABLE 4 - PARAMETER DRIFT VALUES

No.	Characteristics	Symbol	Spec. and/or Test Method	Test Conditions	Change Limits (Δ)	Unit
1	Resonance frequency drift	$\frac{\Delta f}{f}$	As per Table 2	As per Table 2	± 2.0	10^{-6}
2	Resonance resistance drift	$\frac{\Delta R}{R}$	As per Table 2	As per Table 2	± 10 or (1) ± 1.0	% Ω

NOTES 1. Whichever is the highest value.**TABLE 5 - CONDITIONS FOR BURN-IN AND LIFE TEST**

No.	Characteristics	Symbol	Condition	Unit
1	Ambient Temperature	T_{amb}	+85 \pm 5	$^{\circ}\text{C}$

FIGURE 5 - ELECTRICAL CIRCUIT FOR BURN-IN AND LIFE TEST

Not applicable.



4.8 ENVIRONMENTAL AND ENDURANCE TESTS (CHARTS IV AND V OF ESA/SCC GENERIC SPECIFICATION NO. 3501)

4.8.1 Measurements and Inspections on Completion of Environmental Tests

The parameters to be measured and inspections to be performed on completion of environmental tests are scheduled in Table 6. Unless otherwise stated, the measurements shall be performed at $T_{amb} = T_o \pm 2 \text{ }^\circ\text{C}$.

4.8.2 Measurements and Inspections at Intermediate Points and on Completion of Endurance Tests

The parameters to be measured and inspections to be performed at intermediate points and on completion of endurance tests are scheduled in Table 6. Unless otherwise stated, the measurements shall be performed at $T_{amb} = T_o \pm 2 \text{ }^\circ\text{C}$.

4.8.3 Conditions for Operating Life Test (Part of Endurance Testing)

The requirements for the operating life test are specified in Section 9 of ESA/SCC Generic Specification No. 3501. The test shall be performed as a high temperature storage test and the temperature to be applied shall be the maximum operating temperature specified in the individual Tables 1(a) given in this specification.



TABLE 6 - MEASUREMENTS AND INSPECTIONS ON COMPLETION OF ENVIRONMENTAL TESTS AND AT INTERMEDIATE POINTS AND ON COMPLETION OF ENDURANCE TESTING

NO.	ESA/SCC GENERIC SPEC. NO. 3501		MEASUREMENTS AND INSPECTIONS		SYMBOL	LIMITS		UNIT
	ENVIRONMENTAL AND ENDURANCE TESTS (1)	TEST METHOD AND CONDITIONS	IDENTIFICATION	CONDITIONS		Min.	Max.	
01	Electrical Measurements at Reference Temperature	Para. 9.2.4	Electrical Measurements	Table 2		Table 1(a)		
02	Shock	Para. 9.3	Initial Measurements	Table 2 Item 1	f	Table 2 Item 1		10 ⁻⁶
			Resonance Resistance	Table 2 Item 2	R	Table 2 Item 2		
			Final Measurements	Table 2 Item 1	$\frac{\Delta f}{f}$	- 1.0	+ 1.0	
			Resonance Frequency Drift	Table 2 Item 2	$\frac{\Delta R}{R}$	- 10 or (2)	+ 10	
			Resonance Resistance Drift		$\frac{\Delta R}{R}$	- 1.0	+ 1.0	Ω
03	Vibration	Para. 9.4	Initial Measurements	Table 2 Item 1	f	Table 2 Item 1		10 ⁻⁶
			Resonance Resistance	Table 2 Item 2	R	Table 2 Item 2		
			Final Measurements	Table 2 Item 1	$\frac{\Delta f}{f}$	- 1.0	+ 1.0	
			Resonance Frequency Drift	Table 2 Item 2	$\frac{\Delta R}{R}$	- 10 or (2)	+ 10	
			Resonance Resistance Drift		$\frac{\Delta R}{R}$	- 1.0	+ 1.0	Ω
04	Seal Test	Para. 9.5	Fine Leak Gross Leak	Para. 9.5.1 Para. 9.5.2		Para. 9.5.1 Para. 9.5.2		
05	Permanence of Marking	Para. 9.8	Final Measurements Visual Examination	No corrosion or obliteration of marking	-	-	-	-
06	External Visual Inspection	Para. 9.9	Final Measurements Visual Inspection	ESA/SCC No. 20500	-	-	-	-
07	Solderability	Para. 9.13	-	-	-	-	-	-

NOTES

1. The tests in this table refer to either Chart IV or V, and shall be used as applicable.
2. Whichever is the highest value.



TABLE 6 - MEASUREMENTS AND INSPECTIONS ON COMPLETION OF ENVIRONMENTAL TESTS AND AT INTERMEDIATE POINTS AND ON COMPLETION OF ENDURANCE TESTING (Cont.)

NO.	ESA/SCC GENERIC SPEC. NO. 3501		MEASUREMENTS AND INSPECTIONS		SYMBOL	LIMITS		UNIT
	ENVIRONMENTAL AND ENDURANCE TESTS (1)	TEST METHOD AND CONDITIONS	IDENTIFICATION	CONDITIONS		Min.	Max.	
08	Climatic Sequence Dry Heat	Para. 9.14 Para. 9.14.1	Initial Measurements					
			Resonance Frequency	Table 2 Item 1	f	Table 2 Item 1		
09	Cold	Para. 9.14.3	Resonance Resistance	Table 2 Item 2	R	Table 2 Item 2		
			Final Measurements					
10	Damp Heat (Accelerated) Remaining Cycles	Para. 9.14.4	Resonance Frequency	Table 2 Item 1	$\frac{\Delta f}{f}$	-2.0	+2.0	10 ⁻⁶
			Drift					
09	Cold	Para. 9.14.3	Resonance Resistance	Table 2 Item 2	$\frac{\Delta R}{R}$	-10	+10	%
			Drift		ΔR	or (2) -1.0	+1.0	Ω
10	Damp Heat (Accelerated) Remaining Cycles	Para. 9.14.4	Initial Measurements					
			Resonance Frequency	Table 2 Item 1	f	Para. 9.14.1.3 Final Measurements		
09	Cold	Para. 9.14.3	Resonance Resistance	Table 2 Item 2	R	Para. 9.14.1.3 Final Measurements		
			Final Measurements					
10	Damp Heat (Accelerated) Remaining Cycles	Para. 9.14.4	Resonance Frequency	Table 2 Item 1	$\frac{\Delta f}{f}$	-2.0	+2.0	10 ⁻⁶
			Drift					
09	Cold	Para. 9.14.3	Resonance Resistance	Table 2 Item 2	$\frac{\Delta R}{R}$	-10	+10	%
			Drift		ΔR	or (2) -1.0	+1.0	Ω
10	Damp Heat (Accelerated) Remaining Cycles	Para. 9.14.4	Initial Measurements					
			Resonance Frequency	Table 2 Item 1	f	Para. 9.14.3.2 Final Measurements		
09	Cold	Para. 9.14.3	Resonance Resistance	Table 2 Item 2	R	Para. 9.14.3.2 Final Measurements		
			Final Measurements					
10	Damp Heat (Accelerated) Remaining Cycles	Para. 9.14.4	Resonance Frequency	Table 2 Item 1	$\frac{\Delta f}{f}$	-2.0	+2.0	10 ⁻⁶
			Drift					
09	Cold	Para. 9.14.3	Resonance Resistance	Table 2 Item 2	$\frac{\Delta R}{R}$	-10	+10	%
			Drift		ΔR	or (2) -1.0	+1.0	Ω
10	Damp Heat (Accelerated) Remaining Cycles	Para. 9.14.4	Insulation Resistance	Table 2 Item 8	Ri	500	-	M Ω
11	Rapid Change of Temperature	Para. 9.15	Initial Measurements					
			Resonance Frequency	Table 2 Item 1	f	Para. 9.14.4.2 Final Measurements		
09	Cold	Para. 9.14.3	Resonance Resistance	Table 2 Item 2	R	Para. 9.14.4.2 Final Measurements		
			Final Measurements					
10	Damp Heat (Accelerated) Remaining Cycles	Para. 9.14.4	Resonance Frequency	Table 2 Item 1	$\frac{\Delta f}{f}$	-2.0	+2.0	10 ⁻⁶
			Drift					
09	Cold	Para. 9.14.3	Resonance Resistance	Table 2 Item 2	$\frac{\Delta R}{R}$	-10	+10	%
			Drift		ΔR	or (2) -1.0	+1.0	Ω
11	Rapid Change of Temperature	Para. 9.15	Recovery of 2 hours	Table 2 Item 1	$\frac{\Delta f}{f}$	-2.0	+2.0	10 ⁻⁶
			Resonance Frequency	Table 2 Item 1	$\frac{\Delta f}{f}$	-2.0	+2.0	10 ⁻⁶
09	Cold	Para. 9.14.3	Resonance Resistance	Table 2 Item 2	$\frac{\Delta R}{R}$	-10	+10	%
			Drift		ΔR	or (2) -1.0	+1.0	Ω
12	Robustness of Terminations	Para. 9.16	Tensile Strength	Gen. 3501 Para. 9.16.1				
			Visual Examination	No visible damage				
09	Cold	Para. 9.14.3	Bending	Gen. 3501 Para. 9.16.2				
			Visual Examination	No visible damage				

NOTES

- The tests in this table refer to either Chart IV or V, and shall be used as applicable.
- Whichever is the highest value.



TABLE 6 - MEASUREMENTS AND INSPECTIONS ON COMPLETION OF ENVIRONMENTAL TESTS AND AT INTERMEDIATE POINTS AND ON COMPLETION OF ENDURANCE TESTING (Cont.)

NO.	ESA/SCC GENERIC SPEC. NO. 3501		MEASUREMENTS AND INSPECTIONS		SYMBOL	LIMITS		UNIT
	ENVIRONMENTAL AND ENDURANCE TESTS (1)	TEST METHOD AND CONDITIONS	IDENTIFICATION	CONDITIONS		Min.	Max.	
13	Life Test	Para. 9.17	Initial Measurements Resonance Frequency Resonance Resistance Intermediate Measurements Resonance Frequency Drift Resonance Resistance Drift Intermediate Measurements (Chart IV) and Final Measurements (Chart V) Resonance Frequency Drift Resonance Resistance Drift Final Measurements (Chart IV) Resonance Frequency Drift Resonance Resistance Drift	Table 2 Item 1 Table 2 Item 2 At 500 hours Table 2 Item 1 Table 2 Item 2 At 1000 hours Table 2 Item 1 Table 2 Item 2 At 2000 hours Table 2 Item 1 Table 2 Item 2	f R $\frac{\Delta f}{f}$ $\frac{\Delta R}{R}$ ΔR $\frac{\Delta f}{f}$ $\frac{\Delta R}{R}$ ΔR $\frac{\Delta f}{f}$ $\frac{\Delta R}{R}$ ΔR	Table 2 Item 1 Table 2 Item 2 - 2.0 + 2.0 - 10 + 10 or (2) - 1.0 + 1.0 - 2.5 + 2.5 - 10 + 10 or (2) - 1.0 + 1.0 - 3.0 + 3.0 - 10 + 10 or (2) - 1.0 + 1.0	10 ⁻⁶ % Ω 10 ⁻⁶ % Ω 10 ⁻⁶ % Ω	

NOTES

1. The tests in this table refer to either Chart IV or V, and shall be used as applicable.
2. Whichever is the highest value.



TABLE 1(a) - TYPE VARIANT DETAILED INFORMATION

TYPE VARIANT NO. 01

No.	Characteristics	Symbol	Limits		Unit	Remarks
			Min.	Max.		
1	Resonance Frequency	f_L	4.194304		MHz	
2	Reference Temperature	T_o	+28	+32	°C	
3	Overtone Order	-	Fundamental		-	
4	Load Capacitance	C_L	-	30	pF	
5	Rated Drive Level	P_o	0.1		mW	
6	Frequency Adjustment Tolerance	$\frac{\Delta f}{f}$	-10	+10	10^{-6}	At T_o °C
7	Resonance Resistance	R_L	-	10	Ω	Over T_{op} °C
8	Frequency Variation with Temperature over T_{op}	$\frac{\Delta f}{f}$	-10	+10	10^{-6}	From frequency measured at T_o °C
9	Resistance Variation with Temperature over T_{op}	$\frac{\Delta R}{R}$	-20	+20	%	If $R \leq 10\Omega$
			-2.0	+2.0	Ω	
10	Operating Temperature Range	T_{op}	-10	+80	°C	
11	Frequency Variation with Drive Level	$\frac{\Delta f}{f}$	Not applicable		10^{-6}	
12	Resistance Variation with Drive Level	$\frac{\Delta R}{R}$	Not applicable		%	
13	Motional Inductance	L_1	Not applicable		mH	
14	Motional Capacitance	C_1	Not applicable		fF	
15	Static Capacitance	C_o	0	4.0	pF	
16	Q Factor	Q	200 000	-	-	
17	Ratio of Unwanted: Response Resistance to Resonance Resistance or Response Impedance to Resonance Resistance	R_p/R or $ Z_p /R$	2:1	-		In the frequency range: $f_L - 200\text{kHz}$ to $f_L + 200\text{kHz}$
18	Ageing	$\frac{\Delta f}{f}$	-10	+10	10^{-6}	5 years after Burn-in
19	Lead Finish		Type 2			
20	Intended Application		Not applicable			



TABLE 1(a) - TYPE VARIANT DETAILED INFORMATION

TYPE VARIANT NO. 02

No.	Characteristics	Symbol	Limits		Unit	Remarks
			Min.	Max.		
1	Resonance Frequency	f_L	8.192		MHz	
2	Reference Temperature	T_o	+23	+27	°C	
3	Overtone Order	-	Fundamental		-	
4	Load Capacitance	C_L	50		pF	
5	Rated Drive Level	P_o	0.1		mW	
6	Frequency Adjustment Tolerance	$\frac{\Delta f}{f}$	-10	+10	10^{-6}	At T_o °C
7	Resonance Resistance	R_L	-	13	Ω	At T_o °C
8	Frequency Variation with Temperature over T_{op}	$\frac{\Delta f}{f}$	-15	+15	10^{-6}	From frequency measured at T_o °C
9	Resistance Variation with Temperature over T_{op}	$\frac{\Delta R}{R}$	Not applicable		%	
10	Operating Temperature Range	T_{op}	-25	+80	°C	
11	Frequency Variation with Drive Level	$\frac{\Delta f}{f}$	Not applicable		10^{-6}	
12	Resistance Variation with Drive Level	$\frac{\Delta R}{R}$	Not applicable		%	
13	Motional Inductance	L_1	36.5	49.5	mH	
14	Motional Capacitance	C_1	Not applicable		fF	
15	Static Capacitance	C_o	0	4.0	pF	
16	Q Factor	Q	50 000	-	-	
17	Ratio of Unwanted: Response Resistance to Resonance Resistance or Response Impedance to Resonance Resistance	R_p/R or $ Z_p /R$	3:1	-		In the frequency range: $f_L - 100\text{kHz}$ to $f_L + 100\text{kHz}$
18	Ageing	$\frac{\Delta f}{f}$	-30	+30	10^{-6}	
19	Lead Finish		Type '3 or 4'			
20	Intended Application		Not applicable			

**TABLE 1(a) - TYPE VARIANT DETAILED INFORMATION****TYPE VARIANT NO. 03**

No.	Characteristics	Symbol	Limits		Unit	Remarks
			Min.	Max.		
1	Resonance Frequency	f_r	26.0		MHz	
2	Reference Temperature	T_o	+20	+30	°C	
3	Overtone Order	-	3		-	
4	Load Capacitance	C_L	∞		pF	
5	Rated Drive Level	P_o	0.1		mW	
6	Frequency Adjustment Tolerance	$\frac{\Delta f}{f}$	-10	+10	10^{-6}	At T_o °C
7	Resonance Resistance	R_r	-	40	Ω	At T_o °C
8	Frequency Variation with Temperature over T_{op}	$\frac{\Delta f}{f}$	0 -10 -10	+10 +10 0	10^{-6}	From T -20 to +10 °C From T +10 to +50 °C From T +50 to +80 °C
9	Resistance Variation with Temperature over T_{op}	$\frac{\Delta R}{R}$	-20	+20	%	
10	Operating Temperature Range	T_{op}	-25	+80	°C	
11	Frequency Variation with Drive Level	$\frac{\Delta f}{f}$	0.5	0.5	10^{-6}	From $P_{S1} = 0mW$ to $P_{S2} = 0.1mW$
12	Resistance Variation with Drive Level	$\frac{\Delta R}{R}$	-10	+10	%	From $P_{S1} = 0mW$ to $P_{S2} = 0.1mW$
13	Motional Inductance	L_1	20	-	mH	
14	Motional Capacitance	C_1	Not applicable		fF	
15	Static Capacitance	C_o	0	7.0	pF	
16	Q Factor	Q	100 000	-	-	
17	Ratio of Unwanted: Response Resistance to Resonance Resistance or Response Impedance to Resonance Resistance	R_p/R or $ Z_p /R$	10:1	-		In the frequency range: $f_r - 2600kHz$ to $f_r + 2600kHz$
18	Ageing	$\frac{\Delta f}{f}$	-2.0	+2.0	10^{-6}	10 years after Burn-in and ageing
19	Lead Finish		Type 2			
20	Intended Application		Not applicable			



TABLE 1(a) - TYPE VARIANT DETAILED INFORMATION

TYPE VARIANT NO. 04

No.	Characteristics	Symbol	Limits		Unit	Remarks
			Min.	Max.		
1	Resonance Frequency	f_L	7.198		MHz	
2	Reference Temperature	T_o	+23	+27	°C	
3	Overtone Order	-	Fundamental		-	
4	Load Capacitance	C_L	29.7	30.3	pF	
5	Rated Drive Level	P_o	0.1		mW	
6	Frequency Adjustment Tolerance	$\frac{\Delta f}{f}$	-50	+50	10^{-6}	At T_o °C
7	Resonance Resistance	R_L	-	30	Ω	At T_o °C
8	Frequency Variation with Temperature over T_{op}	$\frac{\Delta f}{f}$	-50	+50	10^{-6}	From frequency measured at T_o °C
9	Resistance Variation with Temperature over T_{op}	$\frac{\Delta R}{R}$	Not applicable		%	
10	Operating Temperature Range	T_{op}	-55	+105	°C	
11	Frequency Variation with Drive Level	$\frac{\Delta f}{f}$	Not applicable		10^{-6}	
12	Resistance Variation with Drive Level	$\frac{\Delta R}{R}$	Not applicable		%	
13	Motional Inductance	L_1	Not applicable		mH	
14	Motional Capacitance	C_1	Not applicable		fF	
15	Static Capacitance	C_o	0	7.0	pF	
16	Q Factor	Q	Not applicable		-	
17	Ratio of Unwanted: Response Resistance to Resonance Resistance or Response Impedance to Resonance Resistance	R_p/R or $ Z_p /R$	7:1	-		In the frequency range: f_L -500kHz to f_L +500kHz
18	Ageing	$\frac{\Delta f}{f}$	-7.5	+7.5	10^{-6}	Over 5 years after Burn-in
19	Lead Finish		Type 2			
20	Intended Application		Not applicable			



TABLE 1(a) - TYPE VARIANT DETAILED INFORMATION

TYPE VARIANT NO. 05

No.	Characteristics	Symbol	Limits		Unit	Remarks
			Min.	Max.		
1	Resonance Frequency	f_L	5.0		MHz	
2	Reference Temperature	T_o	+23	+27	°C	
3	Overtone Order	-	Fundamental		-	
4	Load Capacitance	C_L	29.7	30.3	pF	
5	Rated Drive Level	P_o	0.1		mW	
6	Frequency Adjustment Tolerance	$\frac{\Delta f}{f}$	-10	+10	10^{-6}	At T_o °C
7	Resonance Resistance	R_L	-	100	Ω	At T_o °C
8	Frequency Variation with Temperature over T_{op}	$\frac{\Delta f}{f}$	-40	+40	10^{-6}	From frequency measured at T_o °C
9	Resistance Variation with Temperature over T_{op}	$\frac{\Delta R}{R}$	Not applicable		%	
10	Operating Temperature Range	T_{op}	-40	+80	°C	
11	Frequency Variation with Drive Level	$\frac{\Delta f}{f}$	Not applicable		10^{-6}	
12	Resistance Variation with Drive Level	$\frac{\Delta R}{R}$	Not applicable		%	
13	Motional Inductance	L_1	Not applicable		mH	
14	Motional Capacitance	C_1	Not applicable		fF	
15	Static Capacitance	C_o	-	7.0	pF	
16	Q Factor	Q	Not applicable		-	
17	Ratio of Unwanted: Response Resistance to Resonance Resistance or Response Impedance to Resonance Resistance	R_p/R or $ Z_p /R$	4:1	-		In the frequency range: $f_L -500kHz$ to $f_L +500kHz$
18	Ageing	$\frac{\Delta f}{f}$	Not applicable		10^{-6}	
19	Lead Finish		Type 2			
20	Intended Application		Not applicable			

**TABLE 1(a) - TYPE VARIANT DETAILED INFORMATION****TYPE VARIANT NO. 06**

No.	Characteristics	Symbol	Limits		Unit	Remarks
			Min.	Max.		
1	Resonance Frequency	f_L	18.0		MHz	
2	Reference Temperature	T_o	+23	+27	°C	
3	Overtone Order	-	Fundamental		-	
4	Load Capacitance	C_L	29.7	30.3	pF	
5	Rated Drive Level	P_o	0.1		mW	
6	Frequency Adjustment Tolerance	$\frac{\Delta f}{f}$	-10	+10	10^{-6}	At T_o °C
7	Resonance Resistance	R_L	-	20	Ω	At T_o °C
8	Frequency Variation with Temperature over T_{op}	$\frac{\Delta f}{f}$	-20	+20	10^{-6}	From frequency measured at T_o °C
9	Resistance Variation with Temperature over T_{op}	$\frac{\Delta R}{R}$	-20	+20	%	From resistance measured at T_o °C If $R \leq 10\Omega$
			-2.0	+2.0	Ω	
10	Operating Temperature Range	T_{op}	-45	+80	°C	
11	Frequency Variation with Drive Level	$\frac{\Delta f}{f}$	Not applicable		10^{-6}	
12	Resistance Variation with Drive Level	$\frac{\Delta R}{R}$	Not applicable		%	
13	Motional Inductance	L_1	Not applicable		mH	
14	Motional Capacitance	C_1	Not applicable		fF	
15	Static Capacitance	C_o	-	7.0	pF	
16	Q Factor	Q	70 000	-	-	
17	Ratio of Unwanted: Response Resistance to Resonance Resistance or Response Impedance to Resonance Resistance	R_p/R or $ Z_p /R$	2:1	-		In the frequency range: $f_L - 200\text{kHz}$ to $f_L + 200\text{kHz}$
18	Ageing	$\frac{\Delta f}{f}$	-3.0	+3.0	10^{-6}	Over 5 years after Burn-in
19	Lead Finish		Type 2			
20	Intended Application		Not applicable			



TABLE 1(a) - TYPE VARIANT DETAILED INFORMATION

TYPE VARIANT NO. 07

No.	Characteristics	Symbol	Limits		Unit	Remarks
			Min.	Max.		
1	Resonance Frequency	f_L	10		MHz	
2	Reference Temperature	T_o	+23	+27	°C	
3	Overtone Order	-	Fundamental		-	
4	Load Capacitance	C_L	30		pF	
5	Rated Drive Level	P_o	0.1		mW	
6	Frequency Adjustment Tolerance	$\frac{\Delta f}{f}$	-10	+10	10^{-6}	At T_o °C
7	Resonance Resistance	R_L	-	20	Ω	At T_o °C
8	Frequency Variation with Temperature over T_{op}	$\frac{\Delta f}{f}$	-25	+25	10^{-6}	From frequency measured at T_o °C
9	Resistance Variation with Temperature over T_{op}	$\frac{\Delta R}{R}$	Not applicable		%	
10	Operating Temperature Range	T_{op}	-55	+100	°C	
11	Frequency Variation with Drive Level	$\frac{\Delta f}{f}$	Not applicable		10^{-6}	
12	Resistance Variation with Drive Level	$\frac{\Delta R}{R}$	Not applicable		%	
13	Motional Inductance	L_1	Not applicable		mH	
14	Motional Capacitance	C_1	Not applicable		fF	
15	Static Capacitance	C_o	-	7.0	pF	
16	Q Factor	Q	80 000	-	-	
17	Ratio of Unwanted: Response Resistance to Resonance Resistance or Response Impedance to Resonance Resistance	R_p/R or $ Z_p /R$	2:1	-		In the frequency range: f_L -500kHz to f_L +500kHz
18	Ageing	$\frac{\Delta f}{f}$	-5.0	+5.0	10^{-6}	Over 5 years after Burn-in
19	Lead Finish		Type 2			
20	Intended Application		Not applicable			



TABLE 1(a) - TYPE VARIANT DETAILED INFORMATION

TYPE VARIANT NO. 08

No.	Characteristics	Symbol	Limits		Unit	Remarks
			Min.	Max.		
1	Resonance Frequency	f_L	10.0		MHz	
2	Reference Temperature	T_o	+23	+27	°C	
3	Overtone Order	-	Fundamental		-	
4	Load Capacitance	C_L	30		pF	
5	Rated Drive Level	P_o	0.1		mW	
6	Frequency Adjustment Tolerance	$\frac{\Delta f}{f}$	-10	+10	10^{-6}	At T_o °C
7	Resonance Resistance	R_L	-	30	Ω	At T_o °C
8	Frequency Variation with Temperature over T_{op}	$\frac{\Delta f}{f}$	-30	+30	10^{-6}	From frequency measured at T_o °C
9	Resistance Variation with Temperature over T_{op}	$\frac{\Delta R}{R}$	-10	+10	%	From resistance measured at T_o °C If $R < 10\Omega$
			-2.0	+2.0	Ω	
10	Operating Temperature Range	T_{op}	-55	+100	°C	
11	Frequency Variation with Drive Level	$\frac{\Delta f}{f}$	Not applicable		10^{-6}	
12	Resistance Variation with Drive Level	$\frac{\Delta R}{R}$	Not applicable		%	
13	Motional Inductance	L_1	Not applicable		mH	
14	Motional Capacitance	C_1	Not applicable		fF	
15	Static Capacitance	C_o	-	7.0	pF	
16	Q Factor	Q	100 000	-	-	
17	Ratio of Unwanted: Response Resistance to Resonance Resistance or Response Impedance to Resonance Resistance	R_p/R or $ Z_p /R$	2:1	-		In the frequency range: $f_L - 200kHz$ to $f_L + 200kHz$
18	Ageing	$\frac{\Delta f}{f}$	-2.0	+2.0	10^{-6}	Per year after Burn-in
19	Lead Finish		Type 2			
20	Intended Application		XO			



TABLE 1(a) - TYPE VARIANT DETAILED INFORMATION

TYPE VARIANT NO. 09

No.	Characteristics	Symbol	Limits		Unit	Remarks
			Min.	Max.		
1	Resonance Frequency	f_L	50		MHz	
2	Reference Temperature	T_o	+23	+27	°C	
3	Overtone Order	-	3		-	
4	Load Capacitance	C_L	11.9	12.1	pF	
5	Rated Drive Level	P_o	0.1		mW	
6	Frequency Adjustment Tolerance	$\frac{\Delta f}{f}$	-2.0	+2.0	10^{-6}	At T_o °C
7	Resonance Resistance	R_L	-	40	Ω	Over T_{op} °C
8	Frequency Variation with Temperature over T_{op}	$\frac{\Delta f}{f}$	-5.0 -10	+5.0 +10	10^{-4}	From T -20°C to +70°C From T -20°C to +80°C
9	Resistance Variation with Temperature over T_{op}	$\frac{\Delta R}{R}$	Not applicable		%	
10	Operating Temperature Range	T_{op}	-20	+80	°C	
11	Frequency Variation with Drive Level	$\frac{\Delta f}{f}$	Not applicable		10^{-6}	
12	Resistance Variation with Drive Level	$\frac{\Delta R}{R}$	Not applicable		%	
13	Motional Inductance	L_1	Not applicable		mH	
14	Motional Capacitance	C_1	1.7	-	fF	
15	Static Capacitance	C_o	-	6.0	pF	
16	Q Factor	Q	50 000	-	-	
17	Ratio of Unwanted: Response Resistance to Resonance Resistance or Response Impedance to Resonance Resistance	R_p/R or $ Z_p /R$	2.5:1	-		In the frequency range: $f_L - 200\text{kHz}$ to $f_L + 200\text{kHz}$
18	Ageing	$\frac{\Delta f}{f}$	-6.0	+6.0	10^{-6}	Over 5 years
19	Lead Finish		Type 2			
20	Intended Application		VCXO			



TABLE 1(a) - TYPE VARIANT DETAILED INFORMATION

TYPE VARIANT NO. 10

No.	Characteristics	Symbol	Limits		Unit	Remarks
			Min.	Max.		
1	Resonance Frequency	f_L	4.0		MHz	
2	Reference Temperature	T_o	+23	+27	°C	
3	Overtone Order	-	Fundamental		-	
4	Load Capacitance	C_L	30		pF	
5	Rated Drive Level	P_o	0.1		mW	
6	Frequency Adjustment Tolerance	$\frac{\Delta f}{f}$	-10	+10	10^{-6}	At T_o °C
7	Resonance Resistance	R_L	-	25	Ω	At T_o °C
8	Frequency Variation with Temperature over T_{op}	$\frac{\Delta f}{f}$	-30	+30	10^{-6}	From frequency measured at T_o °C
9	Resistance Variation with Temperature over T_{op}	$\frac{\Delta R}{R}$	Not applicable		%	
10	Operating Temperature Range	T_{op}	-40	+80	°C	
11	Frequency variation with Drive Level	$\frac{\Delta f}{f}$	Not applicable		10^{-6}	
12	Resistance variation with Drive Level	$\frac{\Delta R}{R}$	Not applicable		%	
13	Motional Inductance	L_1	Not applicable		mH	
14	Motional Capacitance	C_1	Not applicable		fF	
15	Static Capacitance	C_o	Not applicable		pF	
16	Q Factor	Q	125 000	-	-	
17	Ratio of Unwanted: Response Resistance to Resonance Resistance or Response Impedance to Resonance Resistance	R_p/R or $ Z_p /R$	2:1	-		In the frequency range: f_L -500kHz to f_L +500kHz
18	Ageing	$\frac{\Delta f}{f}$	-3.0	+3.0	10^{-6}	1 year after Burn-in
19	Lead Finish		Type 2			
20	Intended Application		XO			With 54HC04



TABLE 1(a) - TYPE VARIANT DETAILED INFORMATION

TYPE VARIANT NO. 11

No.	Characteristics	Symbol	Limits		Unit	Remarks
			Min.	Max.		
1	Resonance Frequency	f_L	10.0		MHz	
2	Reference Temperature	T_o	+23	+27	°C	
3	Overtone Order	-	Fundamental		-	
4	Load Capacitance	C_L	30		pF	
5	Rated Drive Level	P_o	0.1		mW	
6	Frequency Adjustment Tolerance	$\frac{\Delta f}{f}$	-10	+10	10^{-6}	At T_o °C
7	Resonance Resistance	R_L	-	30	Ω	At T_o °C
8	Frequency Variation with Temperature over T_{op}	$\frac{\Delta f}{f}$	-30	+30	10^{-6}	From frequency measured at T_o °C
9	Resistance Variation with Temperature over T_{op}	$\frac{\Delta R}{R}$	-2.0	+2.0	Ω	From resistance measured at T_o °C
10	Operating Temperature Range	T_{op}	-55	+100	°C	
11	Frequency Variation with Drive Level	$\frac{\Delta f}{f}$	Not applicable		10^{-6}	
12	Resistance Variation with Drive Level	$\frac{\Delta R}{R}$	Not applicable		%	
13	Motional Inductance	L_1	Not applicable		mH	
14	Motional Capacitance	C_1	Not applicable		fF	
15	Static Capacitance	C_o	-	7.0	pF	
16	Q Factor	Q	100 000	-	-	
17	Ratio of Unwanted: Response Resistance to Resonance Resistance or Response Impedance to Resonance Resistance	R_p/R or $ Z_p /R$	2:1	-		In the frequency range: $f_L - 200\text{kHz}$ to $f_L + 200\text{kHz}$
18	Ageing	$\frac{\Delta f}{f}$	-2.0	+2.0	10^{-6}	Per year after Burn-in at T_o
19	Lead Finish		Type 2			
20	Intended Application		XO			



TABLE 1(a) - TYPE VARIANT DETAILED INFORMATION

TYPE VARIANT NO. 12

No.	Characteristics	Symbol	Limits		Unit	Remarks
			Min.	Max.		
1	Resonance Frequency	f_r	8.0		MHz	
2	Reference Temperature	T_o	+ 20	+ 30	°C	
3	Overtone Order	-	Fundamental		-	
4	Load Capacitance	C_L	∞		pF	
5	Rated Drive Level	P_o	0.1		mW	
6	Frequency Adjustment Tolerance	$\frac{\Delta f}{f}$	-10	+ 10	10^{-6}	At T_o °C
7	Resonance Resistance	R_r	-	40	Ω	At T_o °C
8	Frequency Variation with Temperature over T_{op}	$\frac{\Delta f}{f}$	0 -9.0 -9.0	+9.0 +9.0 0	10^{-6}	From T - 20 to + 10 °C From T + 10 to + 50 °C From T + 50 to + 80 °C
9	Resistance Variation with Temperature over T_{op}	$\frac{\Delta R}{R}$	-2.0	+2.0	Ω	From resistance measured at T_o °C
10	Operating Temperature Range	T_{op}	- 20	+ 80	°C	
11	Frequency Variation with Drive Level	$\frac{\Delta f}{f}$	Not applicable		10^{-6}	
12	Resistance Variation with Drive Level	$\frac{\Delta R}{R}$	Not applicable		%	
13	Motional Inductance	L_1	2.0	-	mH	
14	Motional Capacitance	C_1	Not applicable		fF	
15	Static Capacitance	C_o	-	5.0	pF	
16	Q Factor	Q	70 000	-	-	
17	Ratio of Unwanted: Response Resistance to Resonance Resistance or Response Impedance to Resonance Resistance	R_p/R or $ Z_p /R$	2:1	-		In the frequency range: $f_r - 10\%$ to $f_r + 10\%$
18	Ageing	$\frac{\Delta f}{f}$	-5.0	+ 5.0	10^{-6}	12 years after Burn-in
19	Lead Finish		Type 2			
20	Intended Application		XO			



TABLE 1(a) - TYPE VARIANT DETAILED INFORMATION

TYPE VARIANT NO. 13

No.	Characteristics	Symbol	Limits		Unit	Remarks
			Min.	Max.		
1	Resonance Frequency	f_r	10.0		MHz	AT cut
2	Reference Temperature	T_o	+20	+30	°C	
3	Overtone Order	-	3		-	
4	Load Capacitance	C_L	∞		pF	
5	Rated Drive Level	P_o	0.1		mW	
6	Frequency Adjustment Tolerance	$\frac{\Delta f}{f}$	-10	+10	10^{-6}	At T_o °C
7	Resonance Resistance	R_r	-	40	Ω	At T_o °C
8	Frequency Variation with Temperature over T_{op}	$\frac{\Delta f}{f}$	-10	+10	10^{-6}	From frequency measured at T_o °C
9	Resistance Variation with Temperature over T_{op}	$\frac{\Delta R}{R}$	-2.0	+2.0	Ω	From resistance measured at T_o °C
10	Operating Temperature Range	T_{op}	-20	+80	°C	
11	Frequency Variation with Drive Level	$\frac{\Delta f}{f}$	-0.5	+0.5	10^{-6}	From $P_{S1} = 0.01mW$ to $P_{S2} = 0.1mW$
12	Resistance Variation with Drive Level	$\frac{\Delta R}{R}$	-20	+20	%	From $P_{S1} = 0.01mW$ to $P_{S2} = 0.1mW$
13	Motional Inductance	L_1	3.0	-	mH	
14	Motional Capacitance	C_1	Not applicable		fF	
15	Static Capacitance	C_o	-	5.0	pF	
16	Q Factor	Q	70 000	-	-	
17	Ratio of Unwanted: Response Resistance to Resonance Resistance or Response Impedance to Resonance Resistance	R_p/R or $ Z_p /R$	3:1	-		In the frequency range: $f_r - 10\%$ to $f_r + 10\%$
18	Ageing	$\frac{\Delta f}{f}$	-10	+10	10^{-6}	12 years after Burn-in
19	Lead Finish		Type 2			
20	Intended Application		TCXO			



TABLE 1(a) - TYPE VARIANT DETAILED INFORMATION

TYPE VARIANT NO. 14

No.	Characteristics	Symbol	Limits		Unit	Remarks
			Min.	Max.		
1	Resonance Frequency	f_L	6.4		MHz	
2	Reference Temperature	T_o	+23	+27	°C	
3	Overtone Order	-	Fundamental		-	
4	Load Capacitance	C_L	30		pF	
5	Rated Drive Level	P_o	0.1		mW	
6	Frequency Adjustment Tolerance	$\frac{\Delta f}{f}$	-10	+10	10^{-6}	At T_o °C
7	Resonance Resistance	R_L	-	20	Ω	At T_o °C
8	Frequency Variation with Temperature over T_{op}	$\frac{\Delta f}{f}$	-20	+20	10^{-6}	From frequency measured at T_o °C
9	Resistance Variation with Temperature over T_{op}	$\frac{\Delta R}{R}$	-20 -2.0	+20 +2.0	% Ω	From resistance measured at T_o °C If $R < 10\Omega$
10	Operating Temperature Range	T_{op}	-45	+80	°C	
11	Frequency Variation with Drive Level	$\frac{\Delta f}{f}$	Not applicable		10^{-6}	
12	Resistance Variation with Drive Level	$\frac{\Delta R}{R}$	Not applicable		%	
13	Motional Inductance	L_1	Not applicable		mH	
14	Motional Capacitance	C_1	Not applicable		fF	
15	Static Capacitance	C_o	-	7.0	pF	
16	Q Factor	Q	70 000	-	-	
17	Ratio of Unwanted: Response Resistance to Resonance Resistance or Response Impedance to Resonance Resistance	R_p/R or $ Z_p /R$	2:1	-		In the frequency range: $f_L - 200kHz$ to $f_L + 200kHz$
18	Ageing	$\frac{\Delta f}{f}$	-3.0	+3.0	10^{-6}	Per year after Burn-in
19	Lead Finish		Type 4			
20	Intended Application		XO			



TABLE 1(a) - TYPE VARIANT DETAILED INFORMATION

TYPE VARIANT NO. 15

No.	Characteristics	Symbol	Limits		Unit	Remarks
			Min.	Max.		
1	Resonance Frequency	f_r	12.605		MHz	AT cut
2	Reference Temperature	T_o	+20	+30	°C	
3	Overtone Order	-	Fundamental		-	
4	Load Capacitance	C_L	∞		pF	
5	Rated Drive Level	P_o	0.1		mW	
6	Frequency Adjustment Tolerance	$\frac{\Delta f}{f}$	-10	+10	10^{-6}	At T_o °C
7	Resonance Resistance	R_r	-	40	Ω	At T_o °C
8	Frequency Variation with Temperature over T_{op}	$\frac{\Delta f}{f}$	-10	+10	10^{-6}	From frequency measured at T_o °C
9	Resistance Variation with Temperature over T_{op}	$\frac{\Delta R}{R}$	-20 -2.0	+20 +2.0	% Ω	From resistance measured at T_o °C
10	Operating Temperature Range	T_{op}	-20	+60	°C	
11	Frequency Variation with Drive Level	$\frac{\Delta f}{f}$	Not applicable		10^{-6}	
12	Resistance Variation with Drive Level	$\frac{\Delta R}{R}$	Not applicable		%	
13	Motional Inductance	L_1	2.0	-	mH	
14	Motional Capacitance	C_1	Not applicable		fF	
15	Static Capacitance	C_o	-	7.0	pF	
16	Q Factor	Q	70 000	-	-	
17	Ratio of Unwanted: Response Resistance to Resonance Resistance or Response Impedance to Resonance Resistance	R_p/R or $ Z_p /R$	2:1	-		In the frequency range: $f_r - 10\%$ to $f_r + 10\%$
18	Ageing	$\frac{\Delta f}{f}$	-5.0	+5.0	10^{-6}	Operation 12 years
19	Lead Finish		Type 2			
20	Intended Application		TCXO			



TABLE 1(a) - TYPE VARIANT DETAILED INFORMATION

TYPE VARIANT NO. 16

No.	Characteristics	Symbol	Limits		Unit	Remarks
			Min.	Max.		
1	Resonance Frequency	f_L	7.0		MHz	AT cut
2	Reference Temperature	T_o	+23	+27	°C	
3	Overtone Order	-	Fundamental		-	
4	Load Capacitance	C_L	30		pF	
5	Rated Drive Level	P_o	0.1		mW	
6	Frequency Adjustment Tolerance	$\frac{\Delta f}{f}$	-10	+10	10^{-6}	At T_o °C
7	Resonance Resistance	R_L	-	20	Ω	At T_o °C
8	Frequency Variation with Temperature over T_{op}	$\frac{\Delta f}{f}$	-12	+12	10^{-6}	From frequency measured at T_o °C
9	Resistance Variation with Temperature over T_{op}	$\frac{\Delta R}{R}$	-20 -2.0	+20 +2.0	% Ω	From resistance measured at T_o °C
10	Operating Temperature Range	T_{op}	-35	+70	°C	
11	Frequency Variation with Drive Level	$\frac{\Delta f}{f}$	Not applicable		10^{-6}	
12	Resistance Variation with Drive Level	$\frac{\Delta R}{R}$	Not applicable		%	
13	Motional Inductance	L_1	40	-	mH	
14	Motional Capacitance	C_1	Not applicable		fF	
15	Static Capacitance	C_o	-	7.0	pF	
16	Q Factor	Q	100 000	-	-	
17	Ratio of Unwanted: Response Resistance to Resonance Resistance or Response Impedance to Resonance Resistance	R_p/R or $ Z_p /R$	3:1	-		In the frequency range: $f_L - 10\%$ to $f_L + 10\%$
18	Ageing	$\frac{\Delta f}{f}$	-3.0	+3.0	10^{-6}	Per year after Burn-in
19	Lead Finish		Type 2			
20	Intended Application		XO			



TABLE 1(a) - TYPE VARIANT DETAILED INFORMATION

TYPE VARIANT NO. 17

No.	Characteristics	Symbol	Limits		Unit	Remarks
			Min.	Max.		
1	Resonance Frequency	f_r	12.665		MHz	AT cut
2	Reference Temperature	T_o	+20	+30	°C	
3	Overtone Order	-	Fundamental		-	
4	Load Capacitance	C_L	∞		pF	
5	Rated Drive Level	P_o	0.1		mW	
6	Frequency Adjustment Tolerance	$\frac{\Delta f}{f}$	-10	+10	10^{-6}	At T_o °C
7	Resonance Resistance	R_r	-	40	Ω	At T_o °C
8	Frequency Variation with Temperature over T_{op}	$\frac{\Delta f}{f}$	-12	+12	10^{-6}	From frequency measured at T_o °C
9	Resistance Variation with Temperature over T_{op}	$\frac{\Delta R}{R}$	-20	+20	%	From resistance measured at T_o °C
			-2.0	+2.0	Ω	
10	Operating Temperature Range	T_{op}	-20	+80	°C	
11	Frequency variation with Drive Level	$\frac{\Delta f}{f}$	Not applicable		10^{-6}	
12	Resistance variation with Drive Level	$\frac{\Delta R}{R}$	Not applicable		%	
13	Motional Inductance	L_1	2.0	-	mH	
14	Motional Capacitance	C_1	Not applicable		fF	
15	Static Capacitance	C_o	-	7.0	pF	
16	Q Factor	Q	70 000	-	-	
17	Ratio of Unwanted: Response Resistance to Resonance Resistance or Response Impedance to Resonance Resistance	R_p/R or $ Z_p /R$	2:1	-		In the frequency range: $f_r - 10\%$ to $f_r + 10\%$
18	Ageing	$\frac{\Delta f}{f}$	-5.0	+5.0	10^{-6}	Over 12 years after 240 hours Burn-in
19	Lead Finish		Type 2			
20	Intended Application		TCXO			



TABLE 1(a) - TYPE VARIANT DETAILED INFORMATION

TYPE VARIANT NO. 18

No.	Characteristics	Symbol	Limits		Unit	Remarks
			Min.	Max.		
1	Resonance Frequency	f_L	5.760		MHz	AT cut
2	Reference Temperature	T_o	+23	+27	°C	
3	Overtone Order	-	Fundamental		-	
4	Load Capacitance	C_L	29.5	30.5	pF	
5	Rated Drive Level	P_o	0.1		mW	
6	Frequency Adjustment Tolerance	$\frac{\Delta f}{f}$	-10	+10	10^{-6}	At T_o °C
7	Resonance Resistance	R_L	4.0	15	Ω	At T_o °C
8	Frequency Variation with Temperature over T_{op}	$\frac{\Delta f}{f}$	-15	+15	10^{-6}	From frequency measured at T_o °C
9	Resistance Variation with Temperature over T_{op}	$\frac{\Delta R}{R}$	Not applicable		%	
10	Operating Temperature Range	T_{op}	-40	+90	°C	
11	Frequency Variation with Drive Level	$\frac{\Delta f}{f}$	Not applicable		10^{-6}	
12	Resistance Variation with Drive Level	$\frac{\Delta R}{R}$	Not applicable		%	
13	Motional Inductance	L_1	Not applicable		mH	
14	Motional Capacitance	C_1	Not applicable		fF	
15	Static Capacitance	C_o	-	7.0	pF	
16	Q Factor	Q	100 000	-	-	
17	Ratio of Unwanted: Response Resistance to Resonance Resistance or Response Impedance to Resonance Resistance	R_p/R or $ Z_p /R$	3:1	-		In the frequency range: f_L -200kHz to f_L +200kHz
18	Ageing	$\frac{\Delta f}{f}$	-15	+15	10^{-6}	Over 10 years after 240 hours Burn-in
19	Lead Finish		Type 2			
20	Intended Application		XO			



TABLE 1(a) - TYPE VARIANT DETAILED INFORMATION

TYPE VARIANT NO. 19

No.	Characteristics	Symbol	Limits		Unit	Remarks
			Min.	Max.		
1	Resonance Frequency	f_L	8.602893		MHz	AT cut
2	Reference Temperature	T_o	+55	+65	°C	
3	Overtone Order	-	Fundamental		-	
4	Load Capacitance	C_L	30		pF	
5	Rated Drive Level	P_o	0.1		mW	
6	Frequency Adjustment Tolerance	$\frac{\Delta f}{f}$	-10	+10	10^{-6}	At T_o °C
7	Resonance Resistance	R_L	-	30	Ω	At T_o °C
8	Frequency Variation with Temperature over T_{op}	$\frac{\Delta f}{f}$	-12	+12	10^{-6}	From frequency measured at T_o °C
9	Resistance Variation with Temperature over T_{op}	$\frac{\Delta R}{R}$	-20	+20	%	From resistance measured at T_o °C
			-2.0	+2.0	Ω	
10	Operating Temperature Range	T_{op}	-40	+85	°C	
11	Frequency Variation with Drive Level	$\frac{\Delta f}{f}$	Not applicable		10^{-6}	
12	Resistance Variation with Drive Level	$\frac{\Delta R}{R}$	-20	+20	%	From $P_{S1} = 0.01mW$ to $P_{S2} = 0.1mW$
13	Motional Inductance	L_1	2.0	-	mH	
14	Motional Capacitance	C_1	Not applicable		fF	
15	Static Capacitance	C_o	-	5.0	pF	
16	Q Factor	Q	100 000	-	-	
17	Ratio of Unwanted: Response Resistance to Resonance Resistance or Response Impedance to Resonance Resistance	R_p/R or $ Z_p /R$	2:1	-		In the frequency range: $f_L -10%$ to $f_L +10%$
18	Ageing	$\frac{\Delta f}{f}$	-5.0	+5.0	10^{-6}	Over 10 years after 240 hours Burn-in
19	Lead Finish		Type 2			
20	Intended Application		XO			



TABLE 1(a) - TYPE VARIANT DETAILED INFORMATION

TYPE VARIANT NO. 20

No.	Characteristics	Symbol	Limits		Unit	Remarks
			Min.	Max.		
1	Resonance Frequency	f_r	15.104893		MHz	AT cut
2	Reference Temperature	T_o	+20	+30	°C	
3	Overtone Order	-	Fundamental		-	
4	Load Capacitance	C_L	∞		pF	
5	Rated Drive Level	P_o	0.1		mW	
6	Frequency Adjustment Tolerance	$\frac{\Delta f}{f}$	-10	+10	10^{-6}	At T_o °C
7	Resonance Resistance	R_r	-	40	Ω	At T_o °C
8	Frequency Variation with Temperature over T_{op}	$\frac{\Delta f}{f}$	-10	+10	10^{-6}	From frequency measured at T_o °C
9	Resistance Variation with Temperature over T_{op}	$\frac{\Delta R}{R}$	-20 or -2.0	+20 +2.0	% Ω	From resistance measured at T_o °C
10	Operating Temperature Range	T_{op}	-20	+80	°C	
11	Frequency Variation with Drive Level	$\frac{\Delta f}{f}$	Not applicable		10^{-6}	
12	Resistance Variation with Drive Level	$\frac{\Delta R}{R}$	Not applicable		%	
13	Motional Inductance	L_1	2.0	-	mH	
14	Motional Capacitance	C_1	Not applicable		fF	
15	Static Capacitance	C_o	-	7.0	pF	
16	Q Factor	Q	70 000	-	-	
17	Ratio of Unwanted: Response Resistance to Resonance Resistance or Response Impedance to Resonance Resistance	R_p/R or $ Z_p /R$	2:1	-		In the frequency range: $f_r - 10\%$ to $f_r + 10\%$
18	Ageing	$\frac{\Delta f}{f}$	-5.0	+5.0	10^{-6}	Over 12 years after 240 hours Burn-in
19	Lead Finish		Type 2			
20	Intended Application		XO			



TABLE 1(a) - TYPE VARIANT DETAILED INFORMATION

TYPE VARIANT NO. 21

No.	Characteristics	Symbol	Limits		Unit	Remarks
			Min.	Max.		
1	Resonance Frequency	f_L	20.0		MHz	AT cut
2	Reference Temperature	T_o	+23	+27	°C	
3	Overtone Order	-	Fundamental		-	
4	Load Capacitance	C_L	30		pF	
5	Rated Drive Level	P_o	0.1		mW	
6	Frequency Adjustment Tolerance	$\frac{\Delta f}{f}$	-10	+10	10^{-6}	At T_o °C
7	Resonance Resistance	R_L	-	30	Ω	At T_o °C
8	Frequency Variation with Temperature over T_{op}	$\frac{\Delta f}{f}$	-15	+15	10^{-6}	From frequency measured at T_o °C
9	Resistance Variation with Temperature over T_{op}	$\frac{\Delta R}{R}$	-20 -2.0	+20 +2.0	% Ω	From resistance measured at T_o °C
10	Operating Temperature Range	T_{op}	-30	+70	°C	
11	Frequency Variation with Drive Level	$\frac{\Delta f}{f}$	Not applicable		10^{-6}	
12	Resistance Variation with Drive Level	$\frac{\Delta R}{R}$	Not applicable		%	
13	Motional Inductance	L_1	Not applicable		mH	
14	Motional Capacitance	C_1	Not applicable		fF	
15	Static Capacitance	C_o	-	7.0	pF	
16	Q Factor	Q	70 000	-	-	
17	Ratio of Unwanted: Response Resistance to Resonance Resistance or Response Impedance to Resonance Resistance	R_p/R or $ Z_p /R$	2:1	-		In the frequency range: $f_L - 200kHz$ to $f_L + 200kHz$
18	Ageing	$\frac{\Delta f}{f}$	-1.0	+1.0	10^{-6}	Per year after Burn-in
19	Lead Finish		Type 2			
20	Intended Application		XO			



TABLE 1(a) - TYPE VARIANT DETAILED INFORMATION

TYPE VARIANT NO. 22

No.	Characteristics	Symbol	Limits		Unit	Remarks
			Min.	Max.		
1	Resonance Frequency	f_L	13.0		MHz	AT cut
2	Reference Temperature	T_o	+23	+27	°C	
3	Overtone Order	-	Fundamental		-	
4	Load Capacitance	C_L	30		pF	
5	Rated Drive Level	P_o	0.1		mW	
6	Frequency Adjustment Tolerance	$\frac{\Delta f}{f}$	-10	+10	10^{-6}	At T_o °C
7	Resonance Resistance	R_L	-	20	Ω	At T_o °C
8	Frequency Variation with Temperature over T_{op}	$\frac{\Delta f}{f}$	-20	+20	10^{-6}	From frequency measured at T_o °C
9	Resistance Variation with Temperature over T_{op}	$\frac{\Delta R}{R}$	-20	+20	%	From resistance measured at T_o °C
			-2.0	+2.0	Ω	
10	Operating Temperature Range	T_{op}	-40	+80	°C	
11	Frequency Variation with Drive Level	$\frac{\Delta f}{f}$	Not applicable		10^{-6}	
12	Resistance Variation with Drive Level	$\frac{\Delta R}{R}$	Not applicable		%	
13	Motional Inductance	L_1	Not applicable		mH	
14	Motional Capacitance	C_1	Not applicable		fF	
15	Static Capacitance	C_o	-	7.0	pF	
16	Q Factor	Q	70 000	-	-	
17	Ratio of Unwanted: Response Resistance to Resonance Resistance or Response Impedance to Resonance Resistance	R_p/R or $ Z_p /R$	2:1	-		In the frequency range: $f_L - 200\text{kHz}$ to $f_L + 200\text{kHz}$
18	Ageing	$\frac{\Delta f}{f}$	-2.0	+2.0	10^{-6}	Per year after Burn-in
19	Lead Finish		Type 2			
20	Intended Application		XO			



TABLE 1(a) - TYPE VARIANT DETAILED INFORMATION

TYPE VARIANT NO. 23

No.	Characteristics	Symbol	Limits		Unit	Remarks
			Min.	Max.		
1	Resonance Frequency	f_L	10.0		MHz	AT cut
2	Reference Temperature	T_o	+23	+27	°C	
3	Overtone Order	-	Fundamental		-	
4	Load Capacitance	C_L	30		pF	
5	Rated Drive Level	P_o	0.1		mW	
6	Frequency Adjustment Tolerance	$\frac{\Delta f}{f}$	-10	+10	10^{-6}	At T_o °C
7	Resonance Resistance	R_L	-	30	Ω	At T_o °C
8	Frequency Variation with Temperature over T_{op}	$\frac{\Delta f}{f}$	-30	+30	10^{-6}	From frequency measured at T_o °C
9	Resistance Variation with Temperature over T_{op}	$\frac{\Delta R}{R}$	-20	+20	%	From resistance measured at T_o °C
			-2.0	+2.0	Ω	
10	Operating Temperature Range	T_{op}	-55	+100	°C	
11	Frequency variation with Drive Level	$\frac{\Delta f}{f}$	Not applicable		10^{-6}	
12	Resistance variation with Drive Level	$\frac{\Delta R}{R}$	Not applicable		%	
13	Motional Inductance	L_1	Not applicable		mH	
14	Motional Capacitance	C_1	Not applicable		fF	
15	Static Capacitance	C_o	-	7.0	pF	
16	Q Factor	Q	100 000	-	-	
17	Ratio of Unwanted: Response Resistance to Resonance Resistance or Response Impedance to Resonance Resistance	R_p/R or $ Z_p /R$	2:1	-		In the frequency range: $f_L - 200\text{kHz}$ to $f_L + 200\text{kHz}$
18	Ageing	$\frac{\Delta f}{f}$	-2.0	+2.0	10^{-6}	Per year after Burn-in
19	Lead Finish		Type 2			
20	Intended Application		XO			



TABLE 1(a) - TYPE VARIANT DETAILED INFORMATION

TYPE VARIANT NO. 24

No.	Characteristics	Symbol	Limits		Unit	Remarks
			Min.	Max.		
1	Resonance Frequency	f_L	5.242880		MHz	AT cut
2	Reference Temperature	T_o	+60	+60	°C	
3	Overtone Order	-	Fundamental		-	
4	Load Capacitance	C_L	30		pF	
5	Rated Drive Level	P_o	0.1		mW	
6	Frequency Adjustment Tolerance	$\frac{\Delta f}{f}$	-10	+10	10^{-6}	At T_o °C
7	Resonance Resistance	R_L	-	13	Ω	At T_o °C
8	Frequency Variation with Temperature over T_{op}	$\frac{\Delta f}{f}$	-15	+15	10^{-6}	From frequency measured at T_o °C
9	Resistance Variation with Temperature over T_{op}	$\frac{\Delta R}{R}$	Not applicable		%	
10	Operating Temperature Range	T_{op}	-40	+85	°C	
11	Frequency variation with Drive Level	$\frac{\Delta f}{f}$	Not applicable		10^{-6}	
12	Resistance variation with Drive Level	$\frac{\Delta R}{R}$	Not applicable		%	
13	Motional Inductance	L_1	20	-	mH	
14	Motional Capacitance	C_1	Not applicable		fF	
15	Static Capacitance	C_o	-	5.0	pF	
16	Q Factor	Q	50 000	-	-	
17	Ratio of Unwanted: Response Resistance to Resonance Resistance or Response Impedance to Resonance Resistance	R_p/R or $ Z_p /R$	3:1	-		In the frequency range: $f_L - 525kHz$ to $f_L + 525kHz$
18	Ageing	$\frac{\Delta f}{f}$	-3.0	+3.0	10^{-6}	Per year after Burn-in
19	Lead Finish		Type 2			
20	Intended Application		XO			



TABLE 1(a) - TYPE VARIANT DETAILED INFORMATION

TYPE VARIANT NO. 25

No.	Characteristics	Symbol	Limits		Unit	Remarks
			Min.	Max.		
1	Resonance Frequency	f_L	5.6250		MHz	AT cut
2	Reference Temperature	T_o	+20	+30	°C	
3	Overtone Order	-	Fundamental		-	
4	Load Capacitance	C_L	30		pF	
5	Rated Drive Level	P_o	0.1		mW	
6	Frequency Adjustment Tolerance	$\frac{\Delta f}{f}$	-10	+10	10^{-6}	At T_o °C
7	Resonance Resistance	R_L	-	25	Ω	At T_o °C
8	Frequency Variation with Temperature over T_{op}	$\frac{\Delta f}{f}$	-14	+14	10^{-6}	From frequency measured at T_o °C
9	Resistance Variation with Temperature over T_{op}	$\frac{\Delta R}{R}$	-20	+20	%	From resistance measured at T_o °C
			-2.0	+2.0	Ω	
10	Operating Temperature Range	T_{op}	-40	+85	°C	
11	Frequency variation with Drive Level	$\frac{\Delta f}{f}$	-0.5	+0.5	10^{-6}	From $P_{S1} = .01mW$ to $P_{S2} = 0.1mW$
12	Resistance variation with Drive Level	$\frac{\Delta R}{R}$	-20	+20	%	From $P_{S1} = .01mW$ to $P_{S2} = 0.1mW$
13	Motional Inductance	L_1	2.0	-	mH	
14	Motional Capacitance	C_1	Not applicable		fF	
15	Static Capacitance	C_o	-	5.0	pF	
16	Q Factor	Q	10 000	-	-	
17	Ratio of Unwanted: Response Resistance to Resonance Resistance or Response Impedance to Resonance Resistance	R_p/R or $ Z_p /R$	3:1	-		In the frequency range: $f_L - 10\%$ to $f_L + 10\%$
18	Ageing	$\frac{\Delta f}{f}$	-5.0	+5.0	10^{-6}	Over 10 years after Burn-in
19	Lead Finish		Type 2			
20	Intended Application		XO			



TABLE 1(a) - TYPE VARIANT DETAILED INFORMATION

TYPE VARIANT NO. 26

No.	Characteristics	Symbol	Limits		Unit	Remarks
			Min.	Max.		
1	Resonance Frequency	f_L	11.250		MHz	AT cut
2	Reference Temperature	T_o	+23	+27	°C	
3	Overtone Order	-	Fundamental		-	
4	Load Capacitance	C_L	29.7	30.3	pF	
5	Rated Drive Level	P_o	0.1		mW	
6	Frequency Adjustment Tolerance	$\frac{\Delta f}{f}$	-10	+10	10^{-6}	At T_o °C
7	Resonance Resistance	R_L	-	20	Ω	At T_o °C
8	Frequency Variation with Temperature over T_{op}	$\frac{\Delta f}{f}$	-20	+20	10^{-6}	From frequency measured at T_o °C
9	Resistance Variation with Temperature over T_{op}	$\frac{\Delta R}{R}$	Not applicable		%	
10	Operating Temperature Range	T_{op}	-50	+100	°C	
11	Frequency variation with Drive Level	$\frac{\Delta f}{f}$	Not applicable		10^{-6}	
12	Resistance variation with Drive Level	$\frac{\Delta R}{R}$	Not applicable		%	
13	Motional Inductance	L_1	Not applicable		mH	
14	Motional Capacitance	C_1	Not applicable		fF	
15	Static Capacitance	C_o	-	7.0	pF	
16	Q Factor	Q	50 000	-	-	
17	Ratio of Unwanted: Response Resistance to Resonance Resistance or Response Impedance to Resonance Resistance	R_p/R or $ Z_p /R$	7:1	-		In the frequency range: $f_L - 200\text{kHz}$ to $f_L + 200\text{kHz}$
18	Ageing	$\frac{\Delta f}{f}$	-20	+20	10^{-6}	Over 15 years after 240 hours Burn-in
19	Lead Finish		Type 2			
20	Intended Application		XO			



TABLE 1(a) - TYPE VARIANT DETAILED INFORMATION

TYPE VARIANT NO. 27

No.	Characteristics	Symbol	Limits		Unit	Remarks
			Min.	Max.		
1	Resonance Frequency	f_r	8.0		MHz	AT cut
2	Reference Temperature	T_o	+23	+27	°C	
3	Overtone Order	-	Fundamental		-	
4	Load Capacitance	C_L	∞		pF	
5	Rated Drive Level	P_o	0.1		mW	
6	Frequency Adjustment Tolerance	$\frac{\Delta f}{f}$	-10	+10	10^{-6}	At T_o °C
7	Resonance Resistance	R_r	-	30	Ω	At T_o °C
8	Frequency Variation with Temperature over T_{op}	$\frac{\Delta f}{f}$	-10	+10	10^{-6}	From frequency measured at T_o °C
9	Resistance Variation with Temperature over T_{op}	$\frac{\Delta R}{R}$	-20	+20	%	From resistance measured at T_o °C
			-1.0	+1.0	Ω	
10	Operating Temperature Range	T_{op}	-30	+70	°C	
11	Frequency variation with Drive Level	$\frac{\Delta f}{f}$	Not applicable		10^{-6}	
12	Resistance variation with Drive Level	$\frac{\Delta R}{R}$	Not applicable		%	
13	Motional Inductance	L_1	Not applicable		mH	
14	Motional Capacitance	C_1	Not applicable		fF	
15	Static Capacitance	C_o	-	7.0	pF	
16	Q Factor	Q	80 000	-	-	
17	Ratio of Unwanted: Response Resistance to Resonance Resistance or Response Impedance to Resonance Resistance	R_p/R or $ Z_p /R$	2:1	-		In the frequency range: $f_r - 200\text{kHz}$ to $f_r + 200\text{kHz}$
18	Ageing	$\frac{\Delta f}{f}$	-3.0	+3.0	10^{-6}	Per year after Burn-in
19	Lead Finish		Type 2			
20	Intended Application		XO			



TABLE 1(a) - TYPE VARIANT DETAILED INFORMATION

TYPE VARIANT NO. 28

No.	Characteristics	Symbol	Limits		Unit	Remarks
			Min.	Max.		
1	Resonance Frequency	f_L	3.494400		MHz	AT cut
2	Reference Temperature	T_0	+23	+27	°C	
3	Overtone Order	-	Fundamental		-	
4	Load Capacitance	C_L	20	50	pF	
5	Rated Drive Level	P_0	0.1		mW	
6	Frequency Adjustment Tolerance	$\frac{\Delta f}{f}$	-10	+10	10^{-6}	At T_0 °C
7	Resonance Resistance	R_L	-	12	Ω	At T_0 °C
8	Frequency Variation with Temperature over T_{op}	$\frac{\Delta f}{f}$	-20	+20	10^{-6}	From frequency measured at T_0 °C
9	Resistance Variation with Temperature over T_{op}	$\frac{\Delta R}{R}$	Not applicable		%	
10	Operating Temperature Range	T_{op}	-55	+100	°C	
11	Frequency variation with Drive Level	$\frac{\Delta f}{f}$	Not applicable		10^{-6}	
12	Resistance variation with Drive Level	$\frac{\Delta R}{R}$	Not applicable		%	
13	Motional Inductance	L_1	200	-	mH	
14	Motional Capacitance	C_1	Not applicable		fF	
15	Static Capacitance	C_0	-	2.7	pF	
16	Q Factor	Q	400 000	-	-	
17	Ratio of Unwanted: Response Resistance to Resonance Resistance or Response Impedance to Resonance Resistance	R_p/R or $ Z_p /R$	2:1	-		In the frequency range: $f_L - 300\text{kHz}$ to $f_L + 300\text{kHz}$
18	Ageing	$\frac{\Delta f}{f}$	-5.0	+5.0	10^{-6}	Per year after Burn-in
19	Lead Finish		Type 2			
20	Intended Application		XO			



TABLE 1(a) - TYPE VARIANT DETAILED INFORMATION

TYPE VARIANT NO. 29

No.	Characteristics	Symbol	Limits		Unit	Remarks
			Min.	Max.		
1	Resonance Frequency	f_L	3.832		MHz	
2	Reference Temperature	T_o	+ 23	+ 27	°C	
3	Overtone Order	-	Fundamental		-	
4	Load Capacitance	C_L	30		pF	
5	Rated Drive Level	P_o	0.1		mW	
6	Frequency Adjustment Tolerance	$\frac{\Delta f}{f}$	- 10	+ 10	10^{-6}	At T_o °C
7	Resonance Resistance	R_L	-	45	Ω	Over T_{op} °C
8	Frequency Variation with Temperature over T_{op}	$\frac{\Delta f}{f}$	- 17	+ 17	10^{-6}	From frequency measured at T_o °C
9	Resistance Variation with Temperature over T_{op}	$\frac{\Delta R}{R}$	Not applicable		%	
10	Operating Temperature Range	T_{op}	- 40	+ 80	°C	
11	Frequency Variation with Drive Level	$\frac{\Delta f}{f}$	Not applicable		10^{-6}	
12	Resistance Variation with Drive Level	$\frac{\Delta R}{R}$	Not applicable		%	
13	Motional Inductance	L_1	230	-	mH	
14	Motional Capacitance	C_1	Not applicable		fF	
15	Static Capacitance	C_o	-	5.0	pF	
16	Q Factor	Q	125 000	-	-	
17	Ratio of Unwanted: Response Resistance to Resonance Resistance or Response Impedance to Resonance Resistance	R_p/R or $ Z_p /R$	2:1	-		In the frequency range: $f_L - 500\text{kHz}$ to $f_L + 500\text{kHz}$
18	Ageing	$\frac{\Delta f}{f}$	- 3.0	+ 3.0	10^{-6}	Per year after Burn-in
19	Lead Finish		Type 2			
20	Intended Application		XO			



TABLE 1(a) - TYPE VARIANT DETAILED INFORMATION

TYPE VARIANT NO. 30

No.	Characteristics	Symbol	Limits		Unit	Remarks
			Min.	Max.		
1	Resonance Frequency	f_L	3.072		MHz	
2	Reference Temperature	T_o	+23	+27	°C	
3	Overtone Order	-	Fundamental		-	
4	Load Capacitance	C_L	30		pF	
5	Rated Drive Level	P_o	0.1		mW	
6	Frequency Adjustment Tolerance	$\frac{\Delta f}{f}$	-10	+10	10^{-6}	At T_o °C
7	Resonance Resistance	R_L	-	50	Ω	Over T_{op} °C
8	Frequency Variation with Temperature over T_{op}	$\frac{\Delta f}{f}$	-20	+20	10^{-6}	From frequency measured at T_o °C
9	Resistance Variation with Temperature over T_{op}	$\frac{\Delta R}{R}$	Not applicable		%	
10	Operating Temperature Range	T_{op}	-40	+80	°C	
11	Frequency Variation with Drive Level	$\frac{\Delta f}{f}$	Not applicable		10^{-6}	
12	Resistance Variation with Drive Level	$\frac{\Delta R}{R}$	Not applicable		%	
13	Motional Inductance	L_1	230	-	mH	
14	Motional Capacitance	C_1	Not applicable		fF	
15	Static Capacitance	C_o	-	5.0	pF	
16	Q Factor	Q	125 000	-	-	
17	Ratio of Unwanted: Response Resistance to Resonance Resistance or Response Impedance to Resonance Resistance	R_p/R or $ Z_p /R$	2:1	-		In the frequency range: $f_L - 500kHz$ to $f_L + 500kHz$
18	Ageing	$\frac{\Delta f}{f}$	-3.0	+3.0	10^{-6}	Per year after Burn-in
19	Lead Finish		Type 2			
20	Intended Application		XO			



TABLE 1(a) - TYPE VARIANT DETAILED INFORMATION

TYPE VARIANT NO. 31

No.	Characteristics	Symbol	Limits		Unit	Remarks
			Min.	Max.		
1	Resonance Frequency	f_L	4.0		MHz	
2	Reference Temperature	T_o	+ 23	+ 27	°C	
3	Overtone Order	-	Fundamental		-	
4	Load Capacitance	C_L	30		pF	
5	Rated Drive Level	P_o	0.1		mW	
6	Frequency Adjustment Tolerance	$\frac{\Delta f}{f}$	- 10	+ 10	10^{-6}	At T_o °C
7	Resonance Resistance	R_L	-	25	Ω	Over T_{op} °C
8	Frequency Variation with Temperature over T_{op}	$\frac{\Delta f}{f}$	- 17	+ 17	10^{-6}	From frequency measured at T_o °C
9	Resistance Variation with Temperature over T_{op}	$\frac{\Delta R}{R}$	Not applicable		%	
10	Operating Temperature Range	T_{op}	- 40	+ 80	°C	
11	Frequency Variation with Drive Level	$\frac{\Delta f}{f}$	Not applicable		10^{-6}	
12	Resistance Variation with Drive Level	$\frac{\Delta R}{R}$	Not applicable		%	
13	Motional Inductance	L_1	230	-	mH	
14	Motional Capacitance	C_1	Not applicable		fF	
15	Static Capacitance	C_o	-	5.0	pF	
16	Q Factor	Q	125 000	-	-	
17	Ratio of Unwanted: Response Resistance to Resonance Resistance or Response Impedance to Resonance Resistance	R_p/R or $ Z_p /R$	2:1	-		In the frequency range: $f_L - 500\text{kHz}$ to $f_L + 500\text{kHz}$
18	Ageing	$\frac{\Delta f}{f}$	- 3.0	+ 3.0	10^{-6}	Per year after Burn-in
19	Lead Finish		Type 2			
20	Intended Application		XO			



TABLE 1(a) - TYPE VARIANT DETAILED INFORMATION

TYPE VARIANT NO. 32

No.	Characteristics	Symbol	Limits		Unit	Remarks
			Min.	Max.		
1	Resonance Frequency	f_L	16.0		MHz	AT cut
2	Reference Temperature	T_o	+ 23	+ 27	°C	
3	Overtone Order	-	Fundamental		-	
4	Load Capacitance	C_L	30		pF	
5	Rated Drive Level	P_o	0.1		mW	
6	Frequency Adjustment Tolerance	$\frac{\Delta f}{f}$	- 10	+ 10	10^{-6}	At T_o °C
7	Resonance Resistance	R_L	-	30	Ω	At T_o °C
8	Frequency Variation with Temperature over T_{op}	$\frac{\Delta f}{f}$	- 50	+ 50	10^{-6}	From frequency measured at T_o °C
9	Resistance Variation with Temperature over T_{op}	$\frac{\Delta R}{R}$	Not applicable		%	
10	Operating Temperature Range	T_{op}	- 55	+ 125	°C	
11	Frequency Variation with Drive Level	$\frac{\Delta f}{f}$	Not applicable		10^{-6}	
12	Resistance Variation with Drive Level	$\frac{\Delta R}{R}$	Not applicable		%	
13	Motional Inductance	L_1	Not applicable		mH	
14	Motional Capacitance	C_1	Not applicable		fF	
15	Static Capacitance	C_o	-	7.0	pF	
16	Q Factor	Q	50 000	-	-	
17	Ratio of Unwanted: Response Resistance to Resonance Resistance or Response Impedance to Resonance Resistance	R_p/R or $ Z_p /R$	2:1	-		In the frequency range: $f_L - 100\text{kHz}$ to $f_L + 200\text{kHz}$
18	Ageing	$\frac{\Delta f}{f}$	- 3.0	+ 3.0	10^{-6}	Per year after Burn-in
19	Lead Finish		Type 2			
20	Intended Application		XO			



TABLE 1(a) - TYPE VARIANT DETAILED INFORMATION

TYPE VARIANT NO. 33

No.	Characteristics	Symbol	Limits		Unit	Remarks
			Min.	Max.		
1	Resonance Frequency	f_L	11.059200		MHz	AT cut
2	Reference Temperature	T_0	+ 23	+ 27	°C	
3	Overtone Order	-	Fundamental		-	
4	Load Capacitance	C_L	30		pF	
5	Rated Drive Level	P_0	0.1		mW	
6	Frequency Adjustment Tolerance	$\frac{\Delta f}{f}$	- 10	+ 10	10^{-6}	At T_0 °C
7	Resonance Resistance	R_L	-	15	Ω	At T_0 °C
8	Frequency Variation with Temperature over T_{op}	$\frac{\Delta f}{f}$	- 25	+ 25	10^{-6}	From frequency measured at T_0 °C
9	Resistance Variation with Temperature over T_{op}	$\frac{\Delta R}{R}$	- 20 or - 2.0	+ 20 + 2.0	% Ω	From resistance measured at T_0 °C
10	Operating Temperature Range	T_{op}	- 55	+ 100	°C	
11	Frequency Variation with Drive Level	$\frac{\Delta f}{f}$	Not applicable		10^{-6}	
12	Resistance Variation with Drive Level	$\frac{\Delta R}{R}$	Not applicable		%	
13	Motional Inductance	L_1	Not applicable		mH	
14	Motional Capacitance	C_1	Not applicable		fF	
15	Static Capacitance	C_0	-	7.0	pF	
16	Q Factor	Q	70 000	-	-	
17	Ratio of Unwanted: Response Resistance to Resonance Resistance or Response Impedance to Resonance Resistance	R_p/R or $ Z_p /R$	2:1	-		In the frequency range: $f_L - 200\text{kHz}$ to $f_L + 200\text{kHz}$
18	Ageing	$\frac{\Delta f}{f}$	- 1.0	+ 1.0	10^{-6}	Per year after Burn-in
19	Lead Finish		Type 2			
20	Intended Application		XO			



TABLE 1(a) - TYPE VARIANT DETAILED INFORMATION

TYPE VARIANT NO. 34

No.	Characteristics	Symbol	Limits		Unit	Remarks
			Min.	Max.		
1	Resonance Frequency	f_L	12.007125		MHz	AT cut
2	Reference Temperature	T_o	+20	+30	°C	
3	Overtone Order	-	Fundamental		-	
4	Load Capacitance	C_L	30		pF	
5	Rated Drive Level	P_o	0.1		mW	
6	Frequency Adjustment Tolerance	$\frac{\Delta f}{f}$	-10	+10	10^{-6}	At T_o °C
7	Resonance Resistance	R_L	-	15	Ω	At T_o °C
8	Frequency Variation with Temperature over T_{op}	$\frac{\Delta f}{f}$	-20	+20	10^{-6}	From frequency measured at T_o °C
9	Resistance Variation with Temperature over T_{op}	$\frac{\Delta R}{R}$	-20 or -2.0	+20 +2.0	% Ω	From resistance measured at T_o °C
10	Operating Temperature Range	T_{op}	-40	+90	°C	
11	Frequency Variation with Drive Level	$\frac{\Delta f}{f}$	-0.5	+0.5	10^{-6}	
12	Resistance Variation with Drive Level	$\frac{\Delta R}{R}$	-10	+10	%	
13	Motional Inductance	L_1	5.0	-	mH	
14	Motional Capacitance	C_1	Not applicable		fF	
15	Static Capacitance	C_o	-	5.5	pF	
16	Q Factor	Q	70 000	-	-	
17	Ratio of Unwanted: Response Resistance to Resonance Resistance or Response Impedance to Resonance Resistance	R_p/R or $ Z_p /R$	3:1	-		In the frequency range: $f_L - 10\%$ to $f_L + 10\%$
18	Ageing	$\frac{\Delta f}{f}$	-5.0	+5.0	10^{-6}	Over 10 years after Burn-in
19	Lead Finish		Type 2			
20	Intended Application		TCXO			



TABLE 1(a) - TYPE VARIANT DETAILED INFORMATION

TYPE VARIANT NO. 35

No.	Characteristics	Symbol	Limits		Unit	Remarks
			Min.	Max.		
1	Resonance Frequency	f_L	11.0592		MHz	AT cut
2	Reference Temperature	T_0	+23	+27	°C	
3	Overtone Order	-	Fundamental		-	
4	Load Capacitance	C_L	50		pF	
5	Rated Drive Level	P_0	0.1		mW	
6	Frequency Adjustment Tolerance	$\frac{\Delta f}{f}$	-10	+10	10^{-6}	At T_0 °C
7	Resonance Resistance	R_L	-	20	Ω	At T_0 °C
8	Frequency Variation with Temperature over T_{op}	$\frac{\Delta f}{f}$	-30	+30	10^{-6}	From frequency measured at T_0 °C
9	Resistance Variation with Temperature over T_{op}	$\frac{\Delta R}{R}$	-20 or -2.0	+20 +2.0	% Ω	From resistance measured at T_0 °C If $R < 10\Omega$
10	Operating Temperature Range	T_{op}	-55	+100	°C	
11	Frequency Variation with Drive Level	$\frac{\Delta f}{f}$	Not applicable		10^{-6}	
12	Resistance Variation with Drive Level	$\frac{\Delta R}{R}$	Not applicable		%	
13	Motional Inductance	L_1	7.0	-	mH	
14	Motional Capacitance	C_1	Not applicable		fF	
15	Static Capacitance	C_0	-	7.0	pF	
16	Q Factor	Q	100 000	-	-	
17	Ratio of Unwanted: Response Resistance to Resonance Resistance or Response Impedance to Resonance Resistance	R_p/R or $ Z_p /R$	2:1	-		In the frequency range: $f_L - 200\text{kHz}$ to $f_L + 200\text{kHz}$
18	Ageing	$\frac{\Delta f}{f}$	-5.0	+5.0	10^{-6}	Per year after 240 Hour Burn-in
19	Lead Finish		Type 2			
20	Intended Application		XO			

	<p>ESCC Detail Specification No. 3501/009</p>	<p>PAGE 58 ISSUE 2</p>
--	---	----------------------------

APPENDIX 'A'

Page 1 of 1

AGREED DEVIATIONS FOR C-MAC FREQUENCY PRODUCTS (F)

ITEMS AFFECTED	DESCRIPTION OF DEVIATION
Para. 4.2.2	Para. 9.3, Shock: Shall not be performed.
Para. 4.2.3	Para. 9.11, Radiographic Inspection: Shall not be performed.