




**CRYSTAL UNITS IN METAL HOLDER,  
BASED ON TYPE 807,  
FREQUENCY RANGE 4.0 - 140MHZ**

**ESCC Detail Specification No. 3501/008**

(Follow-up specification to ESA/SCC Detail Specification No. 3501/001)

**ISSUE 3  
July 2008**



	ESCC Detail Specification No. 3501/008		PAGE ii ISSUE 2
--	---	--	--------------------


LEGAL DISCLAIMER AND COPYRIGHT

European Space Agency, Copyright © 2008. All rights reserved.

The European Space Agency disclaims any liability or responsibility, to any person or entity, with respect to any loss or damage caused, or alleged to be caused, directly or indirectly by the use and application of this ESCC publication.

This publication, without the prior permission of the European Space Agency and provided that it is not used for a commercial purpose, may be:


- copied in whole in any medium without alteration or modification.
- copied in part, in any medium, provided that the ESCC document identification, comprising the ESCC symbol, document number and document issue, is removed.

	<p>ESCC Detail Specification No. 3501/008</p>		<p>PAGE 2 ISSUE 3</p>
---	---	--	---------------------------

**DOCUMENTATION CHANGE NOTICE**

(Refer to <https://escies.org> for ESCC DCR content)

DCR No.	CHANGE DESCRIPTION
401	Specification upissued to incorporate technical and editorial changes per DCRs.

	<p style="text-align: center;">ESCC Detail Specification No. 3501/008</p>	<p>PAGE 3 ISSUE 3</p>
---	---	---------------------------

**TABLE OF CONTENTS**

		<u>Page</u>
<b>1.</b>	<b><u>GENERAL</u></b>	<b>5</b>
1.1	Scope	5
1.2	Component Type Variants	5
1.3	Maximum Ratings	5
1.4	Physical Dimensions	5
1.5	Functional Diagram	5
<b>2.</b>	<b><u>APPLICABLE DOCUMENTS</u></b>	<b>14</b>
<b>3.</b>	<b><u>TERMS, DEFINITIONS, ABBREVIATIONS, SYMBOLS AND UNITS</u></b>	<b>14</b>
<b>4.</b>	<b><u>REQUIREMENTS</u></b>	<b>14</b>
4.1	General	14
4.2	Deviations from Generic Specification	14
4.2.1	Deviations from Special In-process Controls	14
4.2.2	Deviations from Final Production Tests	14
4.2.3	Deviations from Burn-in Tests	14
4.2.4	Deviations from Qualification Tests	14
4.2.5	Deviations from Lot Acceptance Tests	14
4.3	Mechanical Requirements	15
4.3.1	Dimension Check	15
4.3.2	Weight	15
4.3.3	Robustness of Terminations	15
4.4	Materials and Finishes	15
4.4.1	Case	15
4.4.2	Lead Material and Finish	15
4.5	Marking	15
4.5.1	General	15
4.5.2	The ESCC Component Number	15
4.5.3	Characteristics	16
4.5.4	Traceability Information	16
4.5.5	Manufacturer's Name, Symbol or Code	16
4.6	Electrical Measurements	16
4.6.1	Electrical Measurements at Reference Temperature	16
4.6.2	Electrical Measurements at High and Low Temperatures	16
4.6.3	Circuits for Electrical Measurements	16
4.7	Burn-in Tests	16
4.7.1	Parameter Drift Values	16
4.7.2	Conditions for Burn-in	16
4.7.3	Electrical Circuits for Burn-in	16
4.8	Environmental and Endurance Tests	19
4.8.1	Measurements and Inspections on Completion of Environmental Tests	19
4.8.2	Measurements and Inspections at Intermediate Points and on Completion of Endurance Tests	19
4.8.3	Conditions for Operating Life Test	19

	<p style="text-align: center;">ESCC Detail Specification No. 3501/008</p>		<p>PAGE 4 ISSUE 3</p>
---	---	--	---------------------------

Page

**TABLES**

1(a)	Type Variant Summary	6
	Type Variant Detailed Information	23
1(b)	Maximum Ratings	9
1(c)	Format for Individual Tables 1(a)	10
2	Electrical Measurements at Reference Temperature	17
3	Electrical Measurements at High and Low Temperatures	18
4	Parameter Drift Values	18
5	Conditions for Burn-in and Life Test	18
6	Measurements and Inspections on Completion of Environmental Tests and at Intermediate Points and on Completion of Endurance Testing	20

**FIGURES**

1	Parameter Derating Information	N/A
2	Physical Dimensions	13
3	Functional Diagram	13
4	Circuits for Electrical Measurements	N/A
5	Electrical Circuit for Burn-in and Life Test	N/A

**APPENDICES (Applicable to specific Manufacturers only)**

A	C-MAC Frequency Products (F)	122
---	------------------------------	-----

	<p style="text-align: center;">ESCC Detail Specification No. 3501/008</p>	<p>PAGE 5 ISSUE 3</p>
---	---	---------------------------

## 1.1 SCOPE

This specification details the values, physical and electrical characteristics, test and inspection data for Crystal Units in Metal Holder, based on Type 807, Frequency Range 4.0 - 140MHz.

It shall be read in conjunction with ESCC Generic Specification No. 3501, the requirements for which are supplemented herein.

This is a follow-up specification to ESCC Detail Specification No. 3501/001. ESCC 3501/001 should also be consulted by:-

- (a) Users seeking information concerning the availability of variants additional to those listed in this specification.
- (b) Manufacturers before requesting the introduction of a new variant in accordance with the requirements of Para. 1.2 of this specification.

## 1.2 COMPONENT TYPE VARIANTS

A list of the type variants of the crystal units specified herein, which are also covered by this specification, is given in "Table 1(a) - Type Variant Summary".

For each type variant, the full electrical and physical characteristics are given in individual Tables 1(a) - "Type Variant Detailed Information" at the end of this specification.

The contents of the individual Tables 1(a) shall be as shown in Table 1(c) and the characteristics therein listed shall relate to the design parameters of the individual crystal units, optimised for the intended application.

The specific characteristics shall be negotiated between the Manufacturer and the Orderer. The Manufacturer shall then apply to the ESCC Secretariat for a type variant number for each individual crystal unit concerned, by sending a finalised Table 1(a) which shall also be copied to the Qualifying Space Agency (QSA).

## 1.3 MAXIMUM RATINGS

The maximum ratings, which shall not be exceeded at any time during use or storage, applicable to the crystal units specified herein, are as scheduled in Table 1(b).

## 1.4 PHYSICAL DIMENSIONS

The physical dimensions of the crystal units specified herein are shown in Figure 2.

## 1.5 FUNCTIONAL DIAGRAM

The functional diagram showing lead identification of the crystal units specified herein is shown in Figure 3.

**TABLE 1(a) - TYPE VARIANT SUMMARY**

**N.B.** For additional information concerning Type Variants, see Para. 1.1.

Variant	Resonance Frequency (MHz)	Load Capacitance (C <sub>L</sub> pF)	Reference Temp. (T <sub>o</sub> °C)	Operating Temp. Range (T <sub>op</sub> °C)	Lead Length (Dim. L mm)	
					Min.	Max.
01	83.102493	∞	+25	-25 to +70	12.7	-
02	85.412668	∞	+25	-20 to +70	12.7	-
03	90.833333	∞	+25	-20 to +70	12.7	-
04	90.857143	∞	+25	-20 to +70	12.7	-
05	90.880952	∞	+25	-20 to +70	12.7	-
06	50.0	∞	+25	-20 to +70	12.7	-
07	85.412668	∞	+65	+59 to +71	12.7	-
08	93.988095	∞	+25	-20 to +70	12.7	-
09	94.0	∞	+25	-20 to +70	12.7	-
10	94.095238	∞	+25	-20 to +70	12.7	-
11	94.107143	∞	+25	-20 to +70	12.7	-
12	18.8875	32	+25	-20 to +70	12.7	-
13	16.0	∞	+25	-40 to +85	12.7	-
14	24.6862	30	+25	-20 to +70	12.7	-
15	110.045	∞	+25	-25 to +70	12.7	-
16	110.765	∞	+25	-25 to +70	12.7	-
17	27.5	30	+25	-20 to +50	12.7	-
18	92.852381	∞	+25	-25 to +70	12.7	-
19	92.846032	∞	+25	-25 to +70	12.7	-
20	88.134921	∞	+25	-25 to +70	12.7	-
21	84.0	∞	+70	-20 to +80	12.7	-
22	15.0	25	+25	-55 to +105	12.7	-
23	40.0	∞	+40	0 to +90	12.7	-
24	29.629	∞	+40	0 to +90	12.7	-
25	32.0	∞	+25	-20 to +70	12.7	-
26	14.7456	∞	+25	-55 to +105	12.7	-
27	12.25	32	+25	-30 to +70	12.7	-
28	4.096	25	+25	-55 to +100	12.7	-
29	31.999305	∞	+25	-20 to +60	12.7	-
30	74.801912	∞	+25	-25 to +70	12.7	-
31	78.217213	∞	+25	-25 to +70	12.7	-
32	81.66667	∞	+70	-20 to +70	12.7	-
33	81.00766	∞	+70	-20 to +80	12.7	-
34	90.869921	∞	+25	-25 to +70	12.7	-
35	85.412668	∞	+65	+59 to +71	12.7	-
36	140.0	∞	+25	-20 to +70	12.7	-

**NOTES:** See Page 8.

**TABLE 1(a) - TYPE VARIANT SUMMARY (CONTINUED)**

Variant	Resonance Frequency (MHz)	Load Capacitance (C <sub>L</sub> pF)	Reference Temp. (T <sub>0</sub> °C)	Operating Temp. Range (T <sub>op</sub> °C)	Intend. Application	Lead Length (Dim. L mm)	
						Min.	Max.
37	81.544502	∞	+ 67	-20 to + 80	-	12.7	-
38	81.632635	∞	+ 65	-20 to + 80	-	12.7	-
39	20.0	32	+ 25	-30 to + 70	-	12.7	-
40	83.133333	∞	+ 65	-20 to + 80	-	12.7	-
41	16.0	30	+ 25	-22 to + 90	-	12.7	-
42	20.0	∞	+ 25	-30 to + 95	-	12.7	-
43	83.312841	∞	+ 25	-25 to + 70	-	12.7	-
44	83.316257	∞	+ 25	-25 to + 70	-	12.7	-
45	83.319672	∞	+ 25	-25 to + 70	-	12.7	-
46	83.362503	∞	+ 25	-25 to + 70	-	12.7	-
47	83.340164	∞	+ 25	-25 to + 70	-	12.7	-
48	83.346994	∞	+ 25	-25 to + 70	-	12.7	-
49	83.353825	∞	+ 25	-25 to + 70	-	12.7	-
50	83.360656	∞	+ 25	-25 to + 70	-	12.7	-
51	45.056	∞	+ 25	-25 to + 70	-	12.7	-
52	78.247951	∞	+ 25	-25 to + 70	-	12.7	-
53	78.213798	∞	+ 25	-25 to + 70	-	12.7	-
54	78.227459	∞	+ 25	-25 to + 70	-	12.7	-
55	78.220628	∞	+ 25	-25 to + 70	-	12.7	-
56	81.666667	∞	+ 67	-20 to + 80	-	12.7	-
57	121.714286	∞	+ 25	-20 to + 70	-	12.7	-
58	116.471429	∞	+ 25	-20 to + 70	-	12.7	-
59	4.194304	22	+ 60	-20 to + 70	-	12.7	-
60	16.0	30	+ 25	-30 to + 70	-	12.7	-
61	10.0	30	+ 30	-30 to + 70	-	12.7	-
62	25.0	30	+ 25	-30 to + 80	X0	12.7	-
63	90.0	12	+ 25	-20 to + 85	-	12.7	-
64	83.366142	∞	+ 67	-20 to + 80	-	12.7	-
65	70.975328	∞	+ 25	-25 to + 70	-	12.7	-
66	79.93306	∞	+ 65	-20 to + 80	-	12.7	-
67	79.941257	∞	+ 65	-20 to + 80	-	12.7	-
68	9.2	30	+ 30	-30 to + 70	X0	12.7	-
69	24.0	30	+ 27	-55 to + 100	-	12.7	-
70	76.8315	∞	+ 25	-25 to + 80	-	12.7	-
71	20.0	30	+ 25	-30 to + 80	-	12.7	-
72	20.0	30	+ 25	-55 to + 105	-	12.7	-

**NOTES:** See Page 8.



**TABLE 1(a) - TYPE VARIANT SUMMARY (CONTINUED)**

Variant	Resonance Frequency (MHz)	Load Capacitance (C <sub>L</sub> pF)	Reference Temp. (T <sub>0</sub> °C)	Operating Temp. Range (T <sub>op</sub> °C)	Intend. Application	Lead Length (Dim. L mm)	
						Min.	Max.
73	40.960	∞	+25	-25 to +70	-	12.7	-
74	70.965082	∞	+25	-25 to +70	-	12.7	-
75	79.937158	∞	+65	-20 to +80	-	12.7	-
76	79.945355	∞	+65	-20 to +80	-	12.7	-
77	59.356136	∞	+25	-25 to +70	-	12.7	-
78	18.0	30	+25	-25 to +100	-	12.7	-
79	81.576923	∞	+67	-20 to +80	OCXO	12.7	-
80	86.024590	∞	+25	-20 to +80	TCXO	12.7	-
81	85.983607	∞	+25	-20 to +80	TCXO	12.7	-
82	79.949453	∞	+65	-20 to +80	OCXO	12.7	-
83	79.957650	∞	+65	-20 to +80	OCXO	12.7	-
84	70.970205	∞	+25	-25 to +70	TCXO	12.7	-
85	101.936620	12	+25	-20 to +80	VCXO	12.7	-
86	75.0	12	+25	-20 to +80	VCXO	12.7	-
87	80.0	12	+25	-20 to +80	VCXO	12.7	-
88	74.626318	∞	+25	-20 to +80	TCXO	12.7	-
89	64.791785	∞	+25	-20 to +80	TCXO	12.7	-
90	64.990091	∞	+25	-20 to +80	TCXO	12.7	-
91	64.995773	∞	+25	-20 to +80	TCXO	12.7	-
92	74.677455	∞	+25	-20 to +80	TCXO	12.7	-
93	66.638308	∞	+25	-20 to +80	TCXO	12.7	-
94	66.628692	∞	+25	-20 to +80	TCXO	12.7	-
95	60.091346	∞	+25	-20 to +80	TCXO	12.7	-
96	60.086538	∞	+25	-20 to +80	TCXO	12.7	-
97	37.083333	∞	+25	-20 to +80	TCXO	12.7	-
98	66.612423	∞	+25	-25 to +70	TCXO	12.7	-
99	79.924863	∞	+65	-20 to +80	OCXO	12.7	-

**NOTES**

1. Full electrical and physical characteristics are given in the individual Tables 1(a) at the end of this specification.

**TABLE 1(b) - MAXIMUM RATINGS**

No.	Characteristic	Symbol	Values	Unit	Remarks
1	Nominal Frequency Range	f	4.0 to 140	MHz	Note 1
2	Drive Level Range	P	Note 1	mW	
3	Operating Temperature Range	T <sub>op</sub>	-	°C	Note 2
4	Storage Temperature Range	T <sub>stg</sub>	-65 to +125	°C	Note 3
5	Soldering Temperature	T <sub>sol</sub>	+260	°C	Note 4

**NOTES**

1.

Fundamental and Overtone Order	Approx. Frequency Range (MHz)	Drive Level Range (mW)
Fundamental	4 - 35	0.05 to 0.2
3	30 - 100	0.05 to 0.25
5	80 - 140	0.05 to 0.25

2. See Table 1(a).

3. The duration at maximum storage temperature shall not exceed 16 hours.

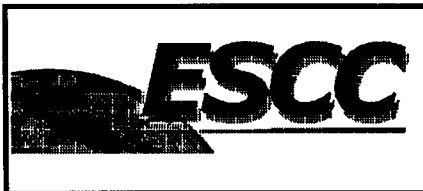
4. Duration 10 seconds maximum at a distance of not less than 3.0mm from the device body and the same lead shall not be resoldered until 3 minutes have elapsed.



**TABLE 1(c) - FORMAT FOR INDIVIDUAL TABLES 1(a)**  
**TABLE 1(a) - TYPE VARIANT DETAILED INFORMATION**  
TYPE VARIANT NO. \_\_\_\_\_

No.	Characteristic	Symbol	Limits		Unit	Remarks
			Min.	Max		
1	Resonance Frequency	$f_r$ or $f_L$			MHz	Note 1
2	Reference Temperature	$T_o$			°C	Note 2
3	Overtone Order	-				
4	Load Capacitance	$C_L$			pF	Note 3
5	Rated Drive Level	$P_o$			mW	Note 4
6	Frequency Adjustment Tolerance	$\frac{\Delta f}{f}$			$10^{-6}$	At $T_o$ °C Note 5
7	Resonance Resistance	$R_r$ or $R_L$			$\Omega$	At $T_o$ °C Note 6
8	Frequency Variation with Temperature over $T_{op}$	$\frac{\Delta f}{f}$			$10^{-9}$	From frequency measured at $T_o$ °C Note 7
9	Resistance Variation with Temperature over $T_{op}$	$\frac{\Delta R}{R}$			%	From resistance measured at $T_o$ °C Note 7
10	Operating Temperature Range	$T_{op}$			°C	
11	Frequency variation with Drive Level	$\frac{\Delta f}{f}$			$10^{-6}$	From $P_{S1} =$ mW to $P_{S2} =$ mW Note 8
12	Resistance variation with Drive Level	$\frac{\Delta R}{R}$			%	From $P_{S1} =$ mW to $P_{S2} =$ mW Note 8
13	Motional Inductance	$L_1$			mH	Notes 9 and 10
14	Motional Capacitance	$C_1$			fF	Note 9
15	Static Capacitance	$C_o$			pF	Note 9
16	Q Factor	Q			-	Notes 9 and 11
17	Ratio of unwanted: Response Resistance to Resonance Resistance or Response Impedance to Resonance Resistance	$R_p/R$ or $ Z_p /R$				In the frequency range: f - kHz to f + kHz
18	Ageing	$\frac{\Delta f}{f}$			$10^{-6}$	Note 13
19	Terminal length	L			mm	Note 14
20	Intended Application					Note 16

**NOTES:** See Pages 11 and 12.



### NOTES TO TABLE 1(c)

1. (a) If  $C_L$  is not specified, Symbol and measurement shall be  $f_r$ .  
(b) If  $C_L$  is specified, Symbol and measurement shall be  $f_L$ .
2. Reference Temperature  $T_0$ 
  - (a) For a crystal unit functioning in a non-controlled temperature environment, the reference temperature is normally  $+25 \pm 2$  °C.
  - (b) For a crystal unit functioning in a controlled temperature environment, the reference temperature shall normally be the mid-point of the temperature range of the controlled environment.
3. Load Capacitance  $C_L$ 
  - (a) When a crystal unit must function at its series resonance frequency,  $C_L$  shall be infinite.
  - (b) When a crystal must function with a load capacitance, the  $C_L$  value shall be specified. The standard values of load capacitance are as follows:
    - Fundamental Frequency Operation: 20pF, 30pF, 50pF and 100pF.
    - Overtone Operation: 8pF, 12pF, 15pF, 20pF and 30pF.

#### **N.B**

The tolerance on the load capacitance shall be that value which results in a frequency change not exceeding 10% of the frequency tolerance at  $T_0$  or 1% of the nominal load capacitance, whichever is smaller.


4. Rated Drive Level  $P_0$ 

The rated drive level shall be selected from the standard drive levels specified below:

  - Preferred values: 2mW, 1mW, 0.5mW, 0.2mW, 0.1mW, 0.05mW, 0.02mW, 0.01mW, 0.001mW or 0.0001mW at  $\pm 20\%$ .
  - Non-preferred values: 10mW, 5mW and 4mW all at  $\pm 20\%$ .
5. Frequency Adjustment Tolerance
  - (a) When a crystal must function at its series resonance frequency, the standard value of the adjustment tolerance shall be  $\pm 10 \times 10^{-6}$ .
  - (b) When a crystal has to function with a load capacitance, the standard value of the adjustment tolerance shall also be  $\pm 10 \times 10^{-6}$ . However, if the load capacitance is adjustable, it is preferable to specify that the nominal frequency be obtained with a load capacitance value between the minimum and maximum value when the crystal is functioning in its fundamental mode.
6. Resonance Resistance
  - (a) Generally, the maximum value only is specified.
  - (b)  $R_L$  may be calculated by  $R_L = R_r \left( 1 + \frac{C_0}{C_L} \right)^2$
7. Frequency and Resistance Variation with Temperature

These values shall be specified such that they are consistent with the operating temperature range.
8. Frequency and Resistance Variation with Drive Level

These limits and the Drive Level range ( $P_{S1}$  to  $P_{S2}$ ) shall be specified for very special crystals only (i.e. crystals used in very high stability oscillators).

	<p style="text-align: center;">ESCC Detail Specification No. 3501/008</p>	<p style="text-align: right;">PAGE 12 ISSUE 3</p>
---	---	---

**NOTES TO TABLE 1(c) (Continued)**

9. Electrical Values

The electrical values shall be specified only when required for the correct functioning of the equipment in which the crystal is used.

10. Motional Inductance  $L_1$

Because the inductance value may be restricted by other chosen parameters, the Manufacturer shall propose the value of  $L_1$  in accordance with the Customer's requirements.

11. 'Q' Factor

If 'R' and 'L' have been already specified, it will not be necessary to specify the minimum value of the 'Q' factor.

The maximum value of the 'Q' factor is never specified.

12. Ratio of Unwanted Response Resistance to Resonance Resistance

The standard minimum value is 2, but it is possible to obtain higher values.

The frequency range within which the minimum value of the ratio is required shall also be specified.

13. Ageing

Specify limits under appropriate column and ageing period under "Remarks".

14. Terminal Lengths

To be specified if different from Figure 2 dimensions. If dimensions are as per Figure 2 then "Figure 2" to be entered in the Limits column.

15. Not applicable Items

For all items where limits are not specified, "Not applicable" shall be entered in the Limits column.

16. Intended Application

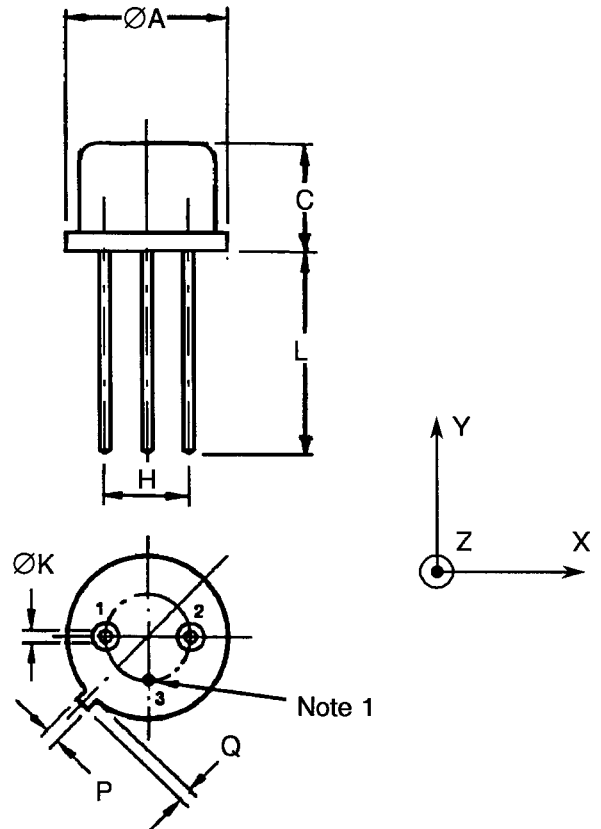
For definitions of the selected symbol to be added, see ESCC Generic Specification No. 3501, Para. 3.

**FIGURE 1 - PARAMETER DERATING INFORMATION**

Not applicable.

**FIGURE 2 - PHYSICAL DIMENSIONS**

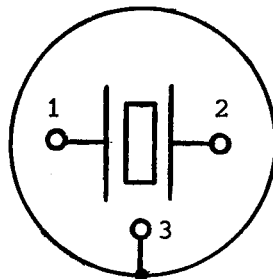
Symbol	Millimetres		Remarks
	Min.	Max.	
$\varnothing A$	-	10.70	-
C	-	6.80	-
H	4.83	5.33	Pitch 5.08mm
$\varnothing K$	0.40	0.48	-
L	12.70	-	-
P	-	0.90	Note 2
Q	-	0.95	Note 2



**NOTES**

1. Lead No.3 is grounded to case.
2. The tag's position or presence is optional.

**FIGURE 3 - FUNCTIONAL DIAGRAM**



(Bottom View)

## 2. APPLICABLE DOCUMENTS

The following documents form part of this specification and shall be read in conjunction with it:-

- (a) ESCC Generic Specification No. 3501 for Quartz Crystal Units.

## 3. TERMS, DEFINITIONS, ABBREVIATIONS, SYMBOLS AND UNITS

For the purpose of this specification, the terms, definitions, abbreviations, symbols and units specified in ESCC Basic Specification No. 21300 shall apply. In addition, the following symbols are used:-

Resonance Frequency	= $f_r$
Load Resonance Frequency	= $f_L$
Reference Temperature	= $T_o$
Resonance Resistance	= $R_r$
Load Resonance Resistance	= $R_L$
Rated Drive Level	= $P_o$
Static Capacitance	= $C_o$
Load Capacitance	= $C_L$
Motional Capacitance	= $C_1$
Motional Inductance	= $L_1$
Response Resistance	= $R_p$
Response Impedance	= $ Z_p $
Insulation Resistance	= $R_i$

## 4. REQUIREMENTS

### 4.1 GENERAL

The complete requirements for procurement of the crystal units specified herein shall be as stated in this specification and ESCC Generic Specification No. 3501 for Quartz Crystal Units. Deviations from the Generic Specification applicable to this specification only, are detailed in Para. 4.2.

Deviations from the applicable Generic Specification and this Detail Specification, formally agreed with specific Manufacturers on the basis that the alternative requirements are equivalent to the ESCC requirements and do not affect the components' reliability, are listed in the appendices attached to this specification.

### 4.2 DEVIATIONS FROM GENERIC SPECIFICATION

#### 4.2.1 Deviations from Special In-process Controls

None.

#### 4.2.2 Deviations from Final Production Tests (Chart II)

None.

#### 4.2.3 Deviations from Burn-in Tests (Chart III)

None.

#### 4.2.4 Deviations from Qualification Tests (Chart IV)

None.

#### 4.2.5 Deviations from Lot Acceptance Tests (Chart V)

None.

4.3 MECHANICAL REQUIREMENTS

4.3.1 Dimension Check

The dimensions of the crystal units specified herein shall be checked. They shall conform to those shown in Figure 2.

4.3.2 Weight

The maximum weight of the crystal units specified herein shall be 2.0 grammes.

4.3.3 Robustness of Terminations

The requirements for robustness of termination testing are specified in Section 9 of ESCC Generic Specification No. 3501.

4.4 MATERIALS AND FINISHES

The materials and finishes shall be as specified herein. Where a definite material is not specified, a material which will enable the crystal units specified herein to meet the performance requirements of this specification shall be used. Acceptance or approval of any constituent material does not guarantee acceptance of the finished product.

4.4.1 Case

4.4.1.1 Cap

Copper, nickel plated or nickel and gold plated.

4.4.1.2 Base

Kovar, nickel plated and gold plated.

4.4.2 Lead Material and Finish

The lead material shall be Type 'D' with Type '2' finish in accordance with the requirements of ESCC Basic Specification No. 23500.

4.5 MARKING

4.5.1 General

The marking of all components delivered to this specification shall be in accordance with the requirements of ESCC Basic Specification No. 21700 and the following paragraphs. When the component is too small to accommodate all of the marking specified, as much as space permits shall be marked and the marking information, in full, shall accompany the component in its primary package.

The information to be marked and the order of precedence, shall be as follows:-

- (a) The ESCC Component Number.
- (b) Characteristics.
- (c) Traceability Information.

4.5.2 The ESCC Component Number

Each component shall bear the SCC Component Number, which shall be constituted and marked as follows:-

350100801B

Detail Specification Number \_\_\_\_\_

Type variant, (see Table 1(a)) \_\_\_\_\_

Testing level (B or C, as applicable) \_\_\_\_\_





#### 4.5.3 Characteristics

The resonance frequency of the crystal units shall be clearly specified in MHz. Where necessary, it shall be specified to 6 decimal places.

#### 4.5.4 Traceability Information

Each component shall be marked in respect of traceability information in accordance with the requirements of ESCC Basic Specification No. 21700.

#### 4.5.5 Manufacturer's Name, Symbol or Code

The Manufacturer's marking shall be in accordance with the requirements of ESCC Basic Specification No. 21700.

### 4.6 ELECTRICAL MEASUREMENTS

#### 4.6.1 Electrical Measurements at Reference Temperature

The parameters to be measured in respect of electrical characteristics are scheduled in Table 2. The measurements shall be performed at the temperatures specified in the individual Tables 1(a), Item 2.

#### 4.6.2 Electrical Measurements at High and Low Temperatures

The parameters to be measured at high and low temperatures are scheduled in Table 3. These measurements shall only be performed if values are specified in Table 1(a) Items 8 and/or 9.

#### 4.6.3 Circuits for Electrical Measurements (Figure 4)

Not applicable.

### 4.7 BURN-IN TESTS

#### 4.7.1 Parameter Drift Values

The parameter drift values applicable to burn-in are specified in Table 4 of this specification. Unless otherwise stated, measurements shall be performed at  $T_{amb} = T_o \pm 2 \text{ }^\circ\text{C}$ . The parameter drift values (Delta) applicable to the scheduled parameters shall not be exceeded. In addition to these drift value requirements for a given parameter, the appropriate limit value specified in Table 2 shall not be exceeded.

#### 4.7.2 Conditions for Burn-in

The requirements for burn-in are specified in Section 7 of ESCC Generic Specification No. 3501. The conditions for burn-in shall be as specified in Table 5 of this specification.

#### 4.7.3 Electrical Circuits for Burn-in (Figure 5)

Not applicable.



**TABLE 2 - ELECTRICAL MEASUREMENTS AT REFERENCE TEMPERATURE**

No.	Characteristics	Symbol	ESCC 3501 Test Method	Limits	Unit
1	Resonance frequency at reference temperature and rated drive level - with C <sub>O</sub> - with C <sub>L</sub>	f <sub>r</sub> (T <sub>o</sub> , P <sub>o</sub> ) f <sub>L</sub> (T <sub>o</sub> , P <sub>o</sub> )	Para. 9.2.1.1	Table 1(a), Item 1 ± Item 6	MHz
2	Resonance resistance at reference temperature and rated drive level - with C <sub>O</sub> - with C <sub>L</sub>	R <sub>r</sub> (T <sub>o</sub> , P <sub>o</sub> ) R <sub>L</sub> (T <sub>o</sub> , P <sub>o</sub> )	Para. 9.2.1.1	Table 1(a), Item 7	Ω
3	Frequency variation with Drive Level	$\frac{\Delta f}{f}$ (T <sub>o</sub> , ΔP)	Para. 9.2.1.1	Table 1(a), Item 11	10 <sup>-6</sup>
4	Resistance variation with Drive Level	$\frac{\Delta R}{R}$ (T <sub>o</sub> , ΔP)	Para. 9.2.1.1	Table 1(a), Item 12	%
5	Motional Inductance	L <sub>1</sub>	Para. 9.2.1.3	Table 1(a), Item 13	mH
6	Static Capacitance	C <sub>o</sub>	Para. 9.2.1.4	Table 1(a), Item 15	pF
7	Unwanted response	R <sub>p</sub> /R or  Z <sub>p</sub>  /R	Para. 9.2.1.5	Table 1(a), Item 17	-
8	Insulation Resistance	R <sub>i</sub>	Para. 9.2.1.6	500 Min.	MΩ

**TABLE 3 - ELECTRICAL MEASUREMENTS AT HIGH AND LOW TEMPERATURES**

No.	Characteristics	Symbol	ESCC 3501 Test Method	Limits	Unit
9	Frequency variation with Temperature over $T_{op}$	$\frac{\Delta f}{f} (\Delta T, P_0)$	Para. 9.2.1.2	Table 1(a) Item 8	$10^{-6}$
10	Resistance variation with Temperature over $T_{op}$	$\frac{\Delta R}{R} (\Delta T, P_0)$	Para. 9.2.1.2	Table 1(a) Item 9	%

**FIGURE 4 - CIRCUITS FOR ELECTRICAL MEASUREMENTS**

Not applicable.

**TABLE 4 - PARAMETER DRIFT VALUES**

No.	Characteristics	Symbol	Spec. and/or Test Method	Test Conditions	Change Limits ( $\Delta$ )	Unit
1	Resonance frequency drift	$\frac{\Delta f}{f}$	As per Table 2	As per Table 2	$\pm 2.0$	$10^{-6}$
2	Resonance resistance drift	$\frac{\Delta R}{R}$	As per Table 2	As per Table 2	$\pm 10$ or (1) $\pm 1.0$	%  $\Omega$

**NOTES**

1. Whichever is the highest value.

**TABLE 5 - CONDITIONS FOR BURN-IN AND LIFE TEST**

No.	Characteristics	Symbol	Condition	Unit
1	Ambient Temperature	$T_{amb}$	$+85 \pm 5$	$^{\circ}\text{C}$

**FIGURE 5 - ELECTRICAL CIRCUIT FOR BURN-IN AND LIFE TEST**

Not applicable.



4.8 ENVIRONMENTAL AND ENDURANCE TESTS (CHARTS IV AND V OF ESCC GENERIC SPECIFICATION NO. 3501)

4.8.1 Measurements and Inspections on Completion of Environmental Tests

The parameters to be measured and inspections to be performed on completion of environmental tests are scheduled in Table 6. Unless otherwise stated, the measurements shall be performed at  $T_{amb} = T_o \pm 2 \text{ }^\circ\text{C}$ .

4.8.2 Measurements and Inspections at Intermediate Points and on Completion of Endurance Tests

The parameters to be measured and inspections to be performed at intermediate points and on completion of endurance tests are scheduled in Table 6. Unless otherwise stated, the measurements shall be performed at  $T_{amb} = T_o \pm 2 \text{ }^\circ\text{C}$ .

4.8.3 Conditions for Operating Life Test (Part of Endurance Testing)

The requirements for the operating life test are specified in Section 9 of ESCC Generic Specification No. 3501. The test shall be performed as a high temperature storage test and the temperature to be applied shall be the maximum operating temperature specified in the individual Tables 1(a) given in this specification.

**TABLE 6 - MEASUREMENTS AND INSPECTIONS ON COMPLETION OF ENVIRONMENTAL TESTS AND AT INTERMEDIATE POINTS AND ON COMPLETION OF ENDURANCE TESTING**

NO.	ESCC GENERIC SPEC. NO. 3501		MEASUREMENTS AND INSPECTIONS		SYMBOL	LIMITS		UNIT
	ENVIRONMENTAL AND ENDURANCE TESTS (1)	TEST METHOD AND CONDITIONS	IDENTIFICATION	CONDITIONS		Min.	Max.	
01	Electrical Measurements at Reference Temperature	Para. 9.2.4	Electrical Measurements	Table 2		Table 1(a)		
02	Shock	Para. 9.3	<b>Initial Measurements</b>	Table 2 Item 1	f	Table 2 Item 1		10 <sup>-6</sup>
			Resonance Resistance	Table 2 Item 2	R	Table 2 Item 2		
			<b>Final Measurements</b>	Table 2 Item 1	$\frac{\Delta f}{f}$	-1.0	+1.0	
			Resonance Frequency Drift	Table 2 Item 2	$\frac{\Delta R}{R}$	-10 or (2)	+10	
			Resonance Resistance Drift		$\Delta R$	-1.0	+1.0	%
			Resonance Resistance Drift		$\Delta R$	-1.0	+1.0	$\Omega$
03	Vibration	Para. 9.4	<b>Initial Measurements</b>	Table 2 Item 1	f	Table 2 Item 1		10 <sup>-6</sup>
			Resonance Frequency	Table 2 Item 2	R	Table 2 Item 2		
			<b>Final Measurements</b>	Table 2 Item 1	$\frac{\Delta f}{f}$	-1.0	+1.0	
			Resonance Frequency Drift	Table 2 Item 2	$\frac{\Delta R}{R}$	-10 or (2)	+10	
			Resonance Resistance Drift		$\Delta R$	-1.0	+1.0	%
			Resonance Resistance Drift		$\Delta R$	-1.0	+1.0	$\Omega$
04	Seal Test	Para. 9.5	Fine Leak Gross Leak	Para. 9.5.1 Para. 9.5.2		Para. 9.5.1 Para. 9.5.2		
05	Permanence of Marking	Para. 9.8	<b>Final Measurements</b> Visual Examination	No corrosion or obliteration of marking	-	-	-	-
06	External Visual Inspection	Para. 9.9	<b>Final Measurements</b> Visual Inspection	ESCC No. 20500	-	-	-	-
07	Solderability	Para. 9.13	-	-	-	-	-	-

**NOTES**

1. The tests in this table refer to either Chart IV or V, and shall be used as applicable.
2. Whichever is the highest value.



**TABLE 6 - MEASUREMENTS AND INSPECTIONS ON COMPLETION OF ENVIRONMENTAL TESTS AND AT INTERMEDIATE POINTS AND ON COMPLETION OF ENDURANCE TESTING (Cont.)**

NO.	ESCC GENERIC SPEC. NO. 3501		MEASUREMENTS AND INSPECTIONS		SYMBOL	LIMITS		UNIT
	ENVIRONMENTAL AND ENDURANCE TESTS (1)	TEST METHOD AND CONDITIONS	IDENTIFICATION	CONDITIONS		Min.	Max.	
08	Climatic Sequence Dry Heat	Para. 9.14 Para. 9.14.1	<b>Initial Measurements</b>					
			Resonance Frequency	Table 2 Item 1	f	Table 2 Item 1		
			Resonance Resistance	Table 2 Item 2	R	Table 2 Item 2		
			<b>Final Measurements</b>					
09	Cold	Para. 9.14.3	Resonance Frequency	Table 2 Item 1	$\frac{\Delta f}{f}$	-2.0	+2.0	10 <sup>-6</sup>
			Resonance Resistance	Table 2 Item 2	$\frac{\Delta R}{R}$	-10	+10	%
			Drift		R	or (2)		
			Drift		$\Delta R$	-1.0	+1.0	$\Omega$
10	Damp Heat (Accelerated) Remaining Cycles	Para. 9.14.4	<b>Initial Measurements</b>					
			Resonance Frequency	Table 2 Item 1	f	Para. 9.14.1.3		
			Resonance Resistance	Table 2 Item 2	R	Final Measurements		
			<b>Final Measurements</b>					
11	Rapid Change of Temperature	Para. 9.15	Resonance Frequency	Table 2 Item 1	$\frac{\Delta f}{f}$	-2.0	+2.0	10 <sup>-6</sup>
			Resonance Resistance	Table 2 Item 2	$\frac{\Delta R}{R}$	-10	+10	%
			Drift	Table 2 Item 1	R	or (2)		
			Drift	Table 2 Item 2	$\Delta R$	-1.0	+1.0	$\Omega$
12	Robustness of Terminations	Para. 9.16	Tensile Strength	Gen. 3501 Para. 9.16.1				
			Visual Examination	No visible damage				
			Bending	Gen. 3501 Para. 9.16.2				
			Visual Examination	No visible damage				

**NOTES**

- The tests in this table refer to either Chart IV or V, and shall be used as applicable.
- Whichever is the highest value.



**TABLE 6 - MEASUREMENTS AND INSPECTIONS ON COMPLETION OF ENVIRONMENTAL TESTS AND AT INTERMEDIATE POINTS AND ON COMPLETION OF ENDURANCE TESTING (Cont.)**

NO.	ESCC GENERIC SPEC. NO. 3501		MEASUREMENTS AND INSPECTIONS		SYMBOL	LIMITS		UNIT
	ENVIRONMENTAL AND ENDURANCE TESTS (1)	TEST METHOD AND CONDITIONS	IDENTIFICATION	CONDITIONS		Min.	Max.	
13	Life Test	Para. 9.17	<b>Initial Measurements</b>					
			Resonance Frequency	Table 2 Item 1	f	Table 2 Item 1		
			Resonance Resistance	Table 2 Item 2	R	Table 2 Item 2		
			<b>Intermediate Measurements</b>	At 500 hours				
			Resonance Frequency	Table 2 Item 1	$\frac{\Delta f}{f}$	-2.0	+2.0	10 <sup>-6</sup>
			Drift					
			Resonance Resistance	Table 2 Item 2	$\frac{\Delta R}{R}$	-10	+10	%
			Drift			or (2)		
					$\Delta R$	-1.0	+1.0	$\Omega$
			<b>Intermediate Measurements (Chart IV) and Final Measurements (Chart V)</b>	At 1000 hours				
			Resonance Frequency	Table 2 Item 1	$\frac{\Delta f}{f}$	-2.5	+2.5	10 <sup>-6</sup>
			Drift					
			Resonance Resistance	Table 2 Item 2	$\frac{\Delta R}{R}$	-10	+10	%
Drift			or (2)					
		$\Delta R$	-1.0	+1.0	$\Omega$			
<b>Final Measurements (Chart IV)</b>	At 2000 hours							
Resonance Frequency	Table 2 Item 1	$\frac{\Delta f}{f}$	-3.0	+3.0	10 <sup>-6</sup>			
Drift								
Resonance Resistance	Table 2 Item 2	$\frac{\Delta R}{R}$	-10	+10	%			
Drift			or (2)					
		$\Delta R$	-1.0	+1.0	$\Omega$			

**NOTES**

1. The tests in this table refer to either Chart IV or V, and shall be used as applicable.
2. Whichever is the highest value.

**TABLE 1(a) - TYPE VARIANT DETAILED INFORMATION**

TYPE VARIANT NO. 01

No.	Characteristics	Symbol	Limits		Unit	Remarks
			Min.	Max.		
1	Resonance Frequency	$f_r$	83.102493		MHz	Swept
2	Reference Temperature	$T_o$	+24	+26	°C	
3	Overtone Order	-	3			
4	Load Capacitance	$C_L$	$\infty$		pF	
5	Rated Drive Level	$P_o$	0.1		mW	
6	Frequency Adjustment Tolerance	$\frac{\Delta f}{f}$	-5.0	+5.0	$10^{-6}$	At $T_o$ °C
7	Resonance Resistance	$R_r$	-	40	$\Omega$	At $T_o$ °C
8	Frequency Variation with Temperature over $T_{op}$	$\frac{\Delta f}{f}$	-9.0	+9.0	$10^{-6}$	From frequency measured at $T_o$ °C
9	Resistance Variation with Temperature over $T_{op}$	$\frac{\Delta R}{R}$	-20	+20	%	From resistance measured at $T_o$ °C
10	Operating Temperature Range	$T_{op}$	-20	+70	°C	
11	Frequency variation with Drive Level	$\frac{\Delta f}{f}$	Not applicable		$10^{-6}$	
12	Resistance variation with Drive Level	$\frac{\Delta R}{R}$	Not applicable		%	
13	Motional Inductance	$L_1$	2.0	-	mH	
14	Motional Capacitance	$C_1$	Not applicable		fF	
15	Static Capacitance	$C_o$	-	7.0	pF	
16	Q Factor	Q	Not applicable		-	
17	Ratio of Unwanted: Response Resistance to Resonance Resistance or Response Impedance to Resonance Resistance	$R_p/R$ or $ Z_{pl} /R$	Not applicable			
18	Ageing	$\frac{\Delta f}{f}$	-3.0 -5.0	+3.0 +5.0	$10^{-6}$	After burn-in, first year. Over 10 years.
19	Terminal Length	L	Figure 2		mm	





**TABLE 1(a) - TYPE VARIANT DETAILED INFORMATION**

TYPE VARIANT NO. 02

No.	Characteristics	Symbol	Limits		Unit	Remarks
			Min.	Max.		
1	Resonance Frequency	$f_r$	84.412668		MHz	Swept
2	Reference Temperature	$T_o$	+24	+26	°C	
3	Overtone Order	-	3			
4	Load Capacitance	$C_L$	$\infty$		pF	
5	Rated Drive Level	$P_o$	0.1		mW	
6	Frequency Adjustment Tolerance	$\frac{\Delta f}{f}$	-5.0	+5.0	$10^{-6}$	At $T_o$ °C
7	Resonance Resistance	$R_r$	-	40	$\Omega$	At $T_o$ °C
8	Frequency Variation with Temperature over $T_{op}$	$\frac{\Delta f}{f}$	-9.0	+9.0	$10^{-6}$	From frequency measured at $T_o$ °C
9	Resistance Variation with Temperature over $T_{op}$	$\frac{\Delta R}{R}$	-20	+20	%	From resistance measured at $T_o$ °C
10	Operating Temperature Range	$T_{op}$	-20	+70	°C	
11	Frequency variation with Drive Level	$\frac{\Delta f}{f}$	Not applicable		$10^{-6}$	
12	Resistance variation with Drive Level	$\frac{\Delta R}{R}$	Not applicable		%	
13	Motional Inductance	$L_1$	2.0	-	mH	
14	Motional Capacitance	$C_1$	Not applicable		fF	
15	Static Capacitance	$C_o$	-	7.0	pF	
16	Q Factor	Q	Not applicable		-	
17	Ratio of Unwanted: Response Resistance to Resonance Resistance or Response Impedance to Resonance Resistance	$R_p/R$ or $iZ_p/R$	2:1	-		In the frequency range: $f_r - 50\text{kHz}$ to $f_r + 50\text{kHz}$
18	Ageing	$\frac{\Delta f}{f}$	-3.0 -5.0	+3.0 +5.0	$10^{-6}$	After burn-in, first year. Over 10 years.
19	Terminal Length	L	Figure 2		mm	

**TABLE 1(a) - TYPE VARIANT DETAILED INFORMATION**

**TYPE VARIANT NO. 03**

No.	Characteristics	Symbol	Limits		Unit	Remarks
			Min.	Max.		
1	Resonance Frequency	$f_r$	90.833333		MHz	Swept
2	Reference Temperature	$T_o$	+24	+26	°C	
3	Overtone Order	-	3			
4	Load Capacitance	$C_L$	$\infty$		pF	
5	Rated Drive Level	$P_o$	0.1		mW	
6	Frequency Adjustment Tolerance	$\frac{\Delta f}{f}$	-5.0	+5.0	$10^{-6}$	At $T_o$ °C
7	Resonance Resistance	$R_r$	-	19	$\Omega$	At $T_o$ °C
8	Frequency Variation with Temperature over $T_{op}$	$\frac{\Delta f}{f}$	-9.0	+9.0	$10^{-6}$	From frequency measured at $T_o$ °C
9	Resistance Variation with Temperature over $T_{op}$	$\frac{\Delta R}{R}$	-20	+20	%	From resistance measured at $T_o$ °C
10	Operating Temperature Range	$T_{op}$	-20	+70	°C	
11	Frequency variation with Drive Level	$\frac{\Delta f}{f}$	Not applicable		$10^{-6}$	
12	Resistance variation with Drive Level	$\frac{\Delta R}{R}$	Not applicable		%	
13	Motional Inductance	$L_1$	2.3	-	mH	
14	Motional Capacitance	$C_1$	Not applicable		fF	
15	Static Capacitance	$C_o$	-	7.0	pF	
16	Q Factor	Q	70 000		-	
17	Ratio of Unwanted: Response Resistance to Resonance Resistance or Response Impedance to Resonance Resistance	$R_p/R$ $ Z_{pl}/R$	2:1	-		In the frequency range: $f_r - 50\text{kHz}$ to $f_r + 50\text{kHz}$
18	Ageing	$\frac{\Delta f}{f}$	-3.0 -5.0	+3.0 +5.0	$10^{-6}$	After burn-in, first year. Over 10 years.
19	Terminal Length	L	Figure 2		mm	

**TABLE 1(a) - TYPE VARIANT DETAILED INFORMATION**

TYPE VARIANT NO. 04

No.	Characteristics	Symbol	Limits		Unit	Remarks
			Min.	Max.		
1	Resonance Frequency	$f_r$	90.857143		MHz	Swept
2	Reference Temperature	$T_0$	+24	+26	°C	
3	Overtone Order	-	3			
4	Load Capacitance	$C_L$	$\infty$		pF	
5	Rated Drive Level	$P_0$	0.1		mW	
6	Frequency Adjustment Tolerance	$\frac{\Delta f}{f}$	-5.0	+5.0	$10^{-6}$	At $T_0$ °C
7	Resonance Resistance	$R_r$	-	19	$\Omega$	At $T_0$ °C
8	Frequency Variation with Temperature over $T_{op}$	$\frac{\Delta f}{f}$	-9.0	+9.0	$10^{-6}$	From frequency measured at $T_0$ °C
9	Resistance Variation with Temperature over $T_{op}$	$\frac{\Delta R}{R}$	-20	+20	%	From resistance measured at $T_0$ °C
10	Operating Temperature Range	$T_{op}$	-20	+70	°C	
11	Frequency variation with Drive Level	$\frac{\Delta f}{f}$	Not applicable		$10^{-6}$	
12	Resistance variation with Drive Level	$\frac{\Delta R}{R}$	Not applicable		%	
13	Motional Inductance	$L_1$	2.3	-	mH	
14	Motional Capacitance	$C_1$	Not applicable		fF	
15	Static Capacitance	$C_0$	-	7.0	pF	
16	Q Factor	Q	70 000	-	-	
17	Ratio of Unwanted: Response Resistance to Resonance Resistance or Response Impedance to Resonance Resistance	$R_p/R$ or $ Z_{pl}/R$	2:1	-		In the frequency range: $f_r - 50\text{kHz}$ to $f_r + 50\text{kHz}$
18	Ageing	$\frac{\Delta f}{f}$	-3.0 -5.0	+3.0 +5.0	$10^{-6}$	After burn-in, first year. Over 10 years.
19	Terminal Length	L	Figure 2		mm	

**TABLE 1(a) - TYPE VARIANT DETAILED INFORMATION**

**TYPE VARIANT NO. 05**

No.	Characteristics	Symbol	Limits		Unit	Remarks
			Min.	Max.		
1	Resonance Frequency	$f_r$	90.880952		MHz	Swept
2	Reference Temperature	$T_o$	+ 24	+ 26	°C	
3	Overtone Order	-	3			
4	Load Capacitance	$C_L$	$\infty$		pF	
5	Rated Drive Level	$P_o$	0.1		mW	
6	Frequency Adjustment Tolerance	$\frac{\Delta f}{f}$	-5.0	+ 5.0	$10^{-6}$	At $T_o$ °C
7	Resonance Resistance	$R_r$	-	19	$\Omega$	At $T_o$ °C
8	Frequency Variation with Temperature over $T_{op}$	$\frac{\Delta f}{f}$	-9.0	+ 9.0	$10^{-6}$	From frequency measured at $T_o$ °C
9	Resistance Variation with Temperature over $T_{op}$	$\frac{\Delta R}{R}$	-20	+ 20	%	From resistance measured at $T_o$ °C
10	Operating Temperature Range	$T_{op}$	-20	+ 70	°C	
11	Frequency variation with Drive Level	$\frac{\Delta f}{f}$	Not applicable		$10^{-6}$	
12	Resistance variation with Drive Level	$\frac{\Delta R}{R}$	Not applicable		%	
13	Motional Inductance	$L_1$	2.3	-	mH	
14	Motional Capacitance	$C_1$	Not applicable		fF	
15	Static Capacitance	$C_o$	-	7.0	pF	
16	Q Factor	Q	70 000	-	-	
17	Ratio of Unwanted: Response Resistance to Resonance Resistance or Response Impedance to Resonance Resistance	$R_p/R$ or $ Z_p /R$	2:1	-		In the frequency range: $f_r - 50\text{kHz}$ to $f_r + 50\text{kHz}$
18	Ageing	$\frac{\Delta f}{f}$	-3.0 -5.0	+ 3.0 + 5.0	$10^{-6}$	After burn-in, first year. Over 10 years.
19	Terminal Length	L	Figure 2		mm	

**TABLE 1(a) - TYPE VARIANT DETAILED INFORMATION**

TYPE VARIANT NO. 06

No.	Characteristics	Symbol	Limits		Unit	Remarks
			Min.	Max.		
1	Resonance Frequency	$f_r$	50.0		MHz	Swept
2	Reference Temperature	$T_o$	+23	+27	°C	
3	Overtone Order	-	3			
4	Load Capacitance	$C_L$	$\infty$		pF	
5	Rated Drive Level	$P_o$	0.1		mW	
6	Frequency Adjustment Tolerance	$\frac{\Delta f}{f}$	-5.0	+5.0	$10^{-6}$	At $T_o$ °C
7	Resonance Resistance	$R_r$	-	23	$\Omega$	At $T_o$ °C
8	Frequency Variation with Temperature over $T_{op}$	$\frac{\Delta f}{f}$	-9.0	+9.0	$10^{-6}$	From frequency measured at $T_o$ °C
9	Resistance Variation with Temperature over $T_{op}$	$\frac{\Delta R}{R}$	-20	+20	%	From resistance measured at $T_o$ °C
10	Operating Temperature Range	$T_{op}$	-20	+70	°C	
11	Frequency variation with Drive Level	$\frac{\Delta f}{f}$	Not applicable		$10^{-6}$	
12	Resistance variation with Drive Level	$\frac{\Delta R}{R}$	Not applicable		%	
13	Motional Inductance	$L_1$	8.0	-	mH	
14	Motional Capacitance	$C_1$	Not applicable		fF	
15	Static Capacitance	$C_o$	-	7.0	pF	
16	Q Factor	Q	110 000	-	-	
17	Ratio of Unwanted: Response Resistance to Resonance Resistance or Response Impedance to Resonance Resistance	$R_p/R$ or $ Z_p /R$	2:1	-		In the frequency range: $f_r - 50\text{kHz}$ to $f_r + 50\text{kHz}$
18	Ageing	$\frac{\Delta f}{f}$	-3.0	+3.0	$10^{-6}$	After burn-in and per year
19	Terminal Length	L	Figure 2		mm	

**TABLE 1(a) - TYPE VARIANT DETAILED INFORMATION**

TYPE VARIANT NO. 07

No.	Characteristics	Symbol	Limits		Unit	Remarks
			Min.	Max.		
1	Resonance Frequency	$f_r$	85.412668		MHz	Swept, AT cut
2	Reference Temperature	$T_o$	+59	+71	°C	
3	Overtone Order	-	5			
4	Load Capacitance	$C_L$	$\infty$		pF	
5	Rated Drive Level	$P_o$	0.1		mW	
6	Frequency Adjustment Tolerance	$\frac{\Delta f}{f}$	-5.0	+5.0	$10^{-6}$	At $T_o$ °C
7	Resonance Resistance	$R_r$	-	50	$\Omega$	At $T_o$ °C
8	Frequency Variation with Temperature over $T_{op}$	$\frac{\Delta f}{f}$	-2.0	+2.0	$10^{-6}$	From frequency measured at $T_o$ °C
9	Resistance Variation with Temperature over $T_{op}$	$\frac{\Delta R}{R}$	-20	+20	%	From resistance measured at $T_o$ °C
10	Operating Temperature Range	$T_{op}$	+59	+71	°C	
11	Frequency variation with Drive Level	$\frac{\Delta f}{f}$	Not applicable		$10^{-6}$	
12	Resistance variation with Drive Level	$\frac{\Delta R}{R}$	Not applicable		%	
13	Motional Inductance	$L_1$	2.0	-	mH	
14	Motional Capacitance	$C_1$	Not applicable		fF	
15	Static Capacitance	$C_o$	-	7.0	pF	
16	Q Factor	Q	70 000	-	-	
17	Ratio of Unwanted: Response Resistance to Resonance Resistance or Response Impedance to Resonance Resistance	$R_p/R$ or $ Z_p /R$	2:1	-		In the frequency range: $f_r - 50\text{kHz}$ to $f_r + 50\text{kHz}$
18	Ageing	$\frac{\Delta f}{f}$	-1.0	+1.0	$10^{-6}$	After burn-in and over 10 years
19	Terminal Length	L	Figure 2		mm	

**TABLE 1(a) - TYPE VARIANT DETAILED INFORMATION**

**TYPE VARIANT NO. 08**

No.	Characteristics	Symbol	Limits		Unit	Remarks
			Min.	Max.		
1	Resonance Frequency	$f_r$	93.988095		MHz	Swept
2	Reference Temperature	$T_o$	+23	+27	°C	
3	Overtone Order	-	3			
4	Load Capacitance	$C_L$	$\infty$		pF	
5	Rated Drive Level	$P_o$	0.1		mW	
6	Frequency Adjustment Tolerance	$\frac{\Delta f}{f}$	-5.0	+5.0	$10^{-6}$	At $T_o$ °C
7	Resonance Resistance	$R_r$	-	17	$\Omega$	At $T_o$ °C
8	Frequency Variation with Temperature over $T_{op}$	$\frac{\Delta f}{f}$	-9.0	+9.0	$10^{-6}$	From frequency measured at $T_o$ °C
9	Resistance Variation with Temperature over $T_{op}$	$\frac{\Delta R}{R}$	-20	+20	%	From resistance measured at $T_o$ °C
10	Operating Temperature Range	$T_{op}$	-20	+70	°C	
11	Frequency variation with Drive Level	$\frac{\Delta f}{f}$	Not applicable		$10^{-6}$	
12	Resistance variation with Drive Level	$\frac{\Delta R}{R}$	Not applicable		%	
13	Motional Inductance	$L_1$	2.0	-	mH	
14	Motional Capacitance	$C_1$	Not applicable		fF	
15	Static Capacitance	$C_o$	-	3.0	pF	
16	Q Factor	Q	70 000	-	-	
17	Ratio of Unwanted: Response Resistance to Resonance Resistance or Response Impedance to Resonance Resistance	$R_p/R$ or $ Z_p /R$	2:1	-		In the frequency range: $f_r - 50\text{kHz}$ to $f_r + 50\text{kHz}$
18	Ageing	$\frac{\Delta f}{f}$	-3.0 -5.0	+3.0 +5.0	$10^{-6}$	After burn-in, first year. Over 10 years.
19	Terminal Length	L	Figure 2		mm	

**TABLE 1(a) - TYPE VARIANT DETAILED INFORMATION**

**TYPE VARIANT NO. 09**

No.	Characteristics	Symbol	Limits		Unit	Remarks
			Min.	Max.		
1	Resonance Frequency	$f_r$	94.0		MHz	Swept
2	Reference Temperature	$T_o$	+23	+27	°C	
3	Overtone Order	-	3			
4	Load Capacitance	$C_L$	$\infty$		pF	
5	Rated Drive Level	$P_o$	0.1		mW	
6	Frequency Adjustment Tolerance	$\frac{\Delta f}{f}$	-5.0	+5.0	$10^{-6}$	At $T_o$ °C
7	Resonance Resistance	$R_r$	-	17	$\Omega$	At $T_o$ °C
8	Frequency Variation with Temperature over $T_{op}$	$\frac{\Delta f}{f}$	-9.0	+9.0	$10^{-6}$	From frequency measured at $T_o$ °C
9	Resistance Variation with Temperature over $T_{op}$	$\frac{\Delta R}{R}$	-20	+20	%	From resistance measured at $T_o$ °C
10	Operating Temperature Range	$T_{op}$	-20	+70	°C	
11	Frequency variation with Drive Level	$\frac{\Delta f}{f}$	Not applicable		$10^{-6}$	
12	Resistance variation with Drive Level	$\frac{\Delta R}{R}$	Not applicable		%	
13	Motional Inductance	$L_1$	2.0	-	mH	
14	Motional Capacitance	$C_1$	Not applicable		fF	
15	Static Capacitance	$C_o$	-	3.0	pF	
16	Q Factor	Q	70 000	-	-	
17	Ratio of Unwanted: Response Resistance to Resonance Resistance or Response Impedance to Resonance Resistance	$R_p/R$ $ Z_p /R$	2:1	-		In the frequency range: $f_r - 50\text{kHz}$ to $f_r + 50\text{kHz}$
18	Ageing	$\frac{\Delta f}{f}$	-3.0 -5.0	+3.0 +5.0	$10^{-6}$	After burn-in, first year. Over 10 years.
19	Terminal Length	L	Figure 2		mm	



**TABLE 1(a) - TYPE VARIANT DETAILED INFORMATION**

**TYPE VARIANT NO. 10**

No.	Characteristics	Symbol	Limits		Unit	Remarks
			Min.	Max.		
1	Resonance Frequency	$f_r$	94.095238		MHz	Swept
2	Reference Temperature	$T_o$	+23	+27	°C	
3	Overtone Order	-	3			
4	Load Capacitance	$C_L$	$\infty$		pF	
5	Rated Drive Level	$P_o$	0.1		mW	
6	Frequency Adjustment Tolerance	$\frac{\Delta f}{f}$	-5.0	+5.0	$10^{-6}$	At $T_o$ °C
7	Resonance Resistance	$R_r$	-	17	$\Omega$	At $T_o$ °C
8	Frequency Variation with Temperature over $T_{op}$	$\frac{\Delta f}{f}$	-9.0	+9.0	$10^{-6}$	From frequency measured at $T_o$ °C
9	Resistance Variation with Temperature over $T_{op}$	$\frac{\Delta R}{R}$	-20	+20	%	From resistance measured at $T_o$ °C
10	Operating Temperature Range	$T_{op}$	-20	+70	°C	
11	Frequency variation with Drive Level	$\frac{\Delta f}{f}$	Not applicable		$10^{-6}$	
12	Resistance variation with Drive Level	$\frac{\Delta R}{R}$	Not applicable		%	
13	Motional Inductance	$L_1$	2.0	-	mH	
14	Motional Capacitance	$C_1$	Not applicable		fF	
15	Static Capacitance	$C_o$	-	3.0	pF	
16	Q Factor	Q	70 000	-	-	
17	Ratio of Unwanted: Response Resistance to Resonance Resistance or Response Impedance to Resonance Resistance	$R_p/R$ $ Z_p /R$	2:1	-		In the frequency range: $f_r - 50\text{kHz}$ to $f_r + 50\text{kHz}$
18	Ageing	$\frac{\Delta f}{f}$	-3.0 -5.0	+3.0 +5.0	$10^{-6}$	After burn-in, first year. Over 10 years.
19	Terminal Length	L	Figure 2		mm	

**TABLE 1(a) - TYPE VARIANT DETAILED INFORMATION**

**TYPE VARIANT NO. 11**

No.	Characteristics	Symbol	Limits		Unit	Remarks
			Min.	Max.		
1	Resonance Frequency	$f_r$	94.107143		MHz	Swept
2	Reference Temperature	$T_o$	+23	+27	°C	
3	Overtone Order	-	3			
4	Load Capacitance	$C_L$	$\infty$		pF	
5	Rated Drive Level	$P_o$	0.1		mW	
6	Frequency Adjustment Tolerance	$\frac{\Delta f}{f}$	-5.0	+5.0	$10^{-6}$	At $T_o$ °C
7	Resonance Resistance	$R_r$	-	17	$\Omega$	At $T_o$ °C
8	Frequency Variation with Temperature over $T_{op}$	$\frac{\Delta f}{f}$	-9.0	+9.0	$10^{-6}$	From frequency measured at $T_o$ °C
9	Resistance Variation with Temperature over $T_{op}$	$\frac{\Delta R}{R}$	-20	+20	%	From resistance measured at $T_o$ °C
10	Operating Temperature Range	$T_{op}$	-20	+70	°C	
11	Frequency variation with Drive Level	$\frac{\Delta f}{f}$	Not applicable		$10^{-6}$	
12	Resistance variation with Drive Level	$\frac{\Delta R}{R}$	Not applicable		%	
13	Motional Inductance	$L_1$	2.0	-	mH	
14	Motional Capacitance	$C_1$	Not applicable		fF	
15	Static Capacitance	$C_o$	-	3.5	pF	
16	Q Factor	Q	70 000	-	-	
17	Ratio of Unwanted: Response Resistance to Resonance Resistance or Response Impedance to Resonance Resistance	$R_p/R$ or $ Z_p /R$	2:1	-		In the frequency range: $f_r - 50\text{kHz}$ to $f_r + 50\text{kHz}$
18	Ageing	$\frac{\Delta f}{f}$	-3.0 -5.0	+3.0 +5.0	$10^{-6}$	After burn-in. Over 10 years
19	Terminal Length	L	Figure 2		mm	

**TABLE 1(a) - TYPE VARIANT DETAILED INFORMATION**

**TYPE VARIANT NO. 12**

No.	Characteristics	Symbol	Limits		Unit	Remarks
			Min.	Max.		
1	Resonance Frequency	$f_L$	18.8875		MHz	
2	Reference Temperature	$T_o$	+ 25		°C	
3	Overtone Order	-	Fundamental			
4	Load Capacitance	$C_L$	32		pF	
5	Rated Drive Level	$P_o$	0.1		mW	
6	Frequency Adjustment Tolerance	$\frac{\Delta f}{f}$	-5.0	+ 5.0	10 <sup>-6</sup>	At $T_o$ °C
7	Resonance Resistance	$R_L$	-	21	Ω	Over $T_{op}$ °C
8	Frequency Variation with Temperature over $T_{op}$	$\frac{\Delta f}{f}$	-7.0	+ 7.0	10 <sup>-6</sup>	From frequency measured at $T_o$ °C
9	Resistance Variation with Temperature over $T_{op}$	$\frac{\Delta R}{R}$	Not applicable		%	
10	Operating Temperature Range	$T_{op}$	-20	+ 70	°C	
11	Frequency variation with Drive Level	$\frac{\Delta f}{f}$	Not applicable		10 <sup>-6</sup>	
12	Resistance variation with Drive Level	$\frac{\Delta R}{R}$	Not applicable		%	
13	Motional Inductance	$L_1$	-	6.93	mH	
14	Motional Capacitance	$C_1$	Not applicable		fF	
15	Static Capacitance	$C_o$	-	3.0	pF	
16	Q Factor	Q	60 000	-	-	
17	Ratio of Unwanted: Response Resistance to Resonance Resistance or Response Impedance to Resonance Resistance	$R_p/R$ or $ Z_p /R$	3:1	-		In the frequency range: $f_L - 200\text{kHz}$ to $f_L + 200\text{kHz}$
18	Ageing	$\frac{\Delta f}{f}$	-5.0	+ 5.0	10 <sup>-6</sup>	After burn-in, per year
19	Terminal Length	L	Figure 2		mm	



**TABLE 1(a) - TYPE VARIANT DETAILED INFORMATION**

**TYPE VARIANT NO. 13**

No.	Characteristics	Symbol	Limits		Unit	Remarks
			Min.	Max.		
1	Resonance Frequency	$f_r$	16.0		MHz	
2	Reference Temperature	$T_o$	+23	+27	°C	
3	Overtone Order	-	Fundamental			
4	Load Capacitance	$C_L$	$\infty$		pF	
5	Rated Drive Level	$P_o$	0.1		mW	
6	Frequency Adjustment Tolerance	$\frac{\Delta f}{f}$	-10	+10	$10^{-6}$	At $T_o$ °C
7	Resonance Resistance	$R_r$	-	18	$\Omega$	At $T_o$ °C
8	Frequency Variation with Temperature over $T_{op}$	$\frac{\Delta f}{f}$	-15	+15	$10^{-6}$	From frequency measured at $T_o$ °C
9	Resistance Variation with Temperature over $T_{op}$	$\frac{\Delta R}{R}$	-10 or -1.5	+10 +1.5	% $\Omega$	From resistance measured at $T_o$ °C If $R < 10\Omega$
10	Operating Temperature Range	$T_{op}$	-40	+85	°C	
11	Frequency variation with Drive Level	$\frac{\Delta f}{f}$	Not applicable		$10^{-6}$	
12	Resistance variation with Drive Level	$\frac{\Delta R}{R}$	Not applicable		%	
13	Motional Inductance	$L_1$	7.0	-	mH	
14	Motional Capacitance	$C_1$	Not applicable		fF	
15	Static Capacitance	$C_o$	-	7.0	pF	
16	Q Factor	Q	60 000	-	-	
17	Ratio of Unwanted: Response Resistance to Resonance Resistance or Response Impedance to Resonance Resistance	$R_p/R$ $ Z_p /R$	2:1	-		In the frequency range: $f_r - 200\text{kHz}$ to $f_r + 200\text{kHz}$
18	Ageing	$\frac{\Delta f}{f}$	-3.0	+3.0	$10^{-6}$	After burn-in, per year
19	Terminal Length	L	Figure 2		mm	

**TABLE 1(a) - TYPE VARIANT DETAILED INFORMATION**

**TYPE VARIANT NO. 14**

No.	Characteristics	Symbol	Limits		Unit	Remarks
			Min.	Max.		
1	Resonance Frequency	$f_L$	24.6862		MHz	
2	Reference Temperature	$T_o$	+ 23	+ 27	°C	
3	Overtone Order	-	Fundamental			
4	Load Capacitance	$C_L$	30		pF	
5	Rated Drive Level	$P_o$	0.1		mW	
6	Frequency Adjustment Tolerance	$\frac{\Delta f}{f}$	-10	+ 10	$10^{-6}$	At $T_o$ °C
7	Resonance Resistance	$R_L$	-	10	$\Omega$	Over $T_{op}$ °C
8	Frequency Variation with Temperature over $T_{op}$	$\frac{\Delta f}{f}$	-10	+ 10	$10^{-6}$	From frequency measured at $T_o$ °C
9	Resistance Variation with Temperature over $T_{op}$	$\frac{\Delta R}{R}$	Not applicable		%	
10	Operating Temperature Range	$T_{op}$	-20	+ 70	°C	
11	Frequency variation with Drive Level	$\frac{\Delta f}{f}$	Not applicable		$10^{-6}$	
12	Resistance variation with Drive Level	$\frac{\Delta R}{R}$	Not applicable		%	
13	Motional Inductance	$L_1$	2.7	-	mH	
14	Motional Capacitance	$C_1$	Not applicable		fF	
15	Static Capacitance	$C_o$	-	5.0	pF	
16	Q Factor	Q	40 000	-	-	
17	Ratio of Unwanted: Response Resistance to Resonance Resistance or Response Impedance to Resonance Resistance	$R_p/R$ or $ Z_p /R$	4:1 5:1	- -		In the frequency range: $f_L - 50\text{kHz}$ to $f_L + 50\text{kHz}$  Overtones 3 and 5
18	Ageing	$\frac{\Delta f}{f}$	-2.9	+ 2.9	$10^{-6}$	After burn-in, over 4 years
19	Terminal Length	L	Figure 2		mm	

**TABLE 1(a) - TYPE VARIANT DETAILED INFORMATION**

**TYPE VARIANT NO. 15**

No.	Characteristics	Symbol	Limits		Unit	Remarks
			Min.	Max.		
1	Resonance Frequency	$f_r$	110.045		MHz	Swept.
2	Reference Temperature	$T_o$	+23	+27	°C	
3	Overtone Order	-	5			AT cut.
4	Load Capacitance	$C_L$	$\infty$		pF	
5	Rated Drive Level	$P_o$	0.1		mW	
6	Frequency Adjustment Tolerance	$\frac{\Delta f}{f}$	-5.0	+5.0	$10^{-6}$	At $T_o$ °C
7	Resonance Resistance	$R_r$	-	45	$\Omega$	At $T_o$ °C
8	Frequency Variation with Temperature over $T_{op}$	$\frac{\Delta f}{f}$	-10	+10	$10^{-6}$	From frequency measured at $T_o$ °C
9	Resistance Variation with Temperature over $T_{op}$	$\frac{\Delta R}{R}$	-10	+10	%	From resistance measured at $T_o$ °C
10	Operating Temperature Range	$T_{op}$	-25	+70	°C	
11	Frequency variation with Drive Level	$\frac{\Delta f}{f}$	Not applicable		$10^{-6}$	
12	Resistance variation with Drive Level	$\frac{\Delta R}{R}$	Not applicable		%	
13	Motional Inductance	$L_1$	4.5	5.5	mH	
14	Motional Capacitance	$C_1$	Not applicable		fF	
15	Static Capacitance	$C_o$	-	3.0	pF	
16	Q Factor	Q	80 000	-	-	
17	Ratio of Unwanted: Response Resistance to Resonance Resistance or Response Impedance to Resonance Resistance	$R_p/R$ $ Z_p /R$	2:1	-		In the frequency range: $f_r - 50\text{kHz}$ to $f_r + 50\text{kHz}$
18	Ageing	$\frac{\Delta f}{f}$	-0.5 -1.0	+0.5 +1.0	$10^{-6}$	First year after burn-in. Over 5 years
19	Terminal Length	L	Figure 2		mm	



**TABLE 1(a) - TYPE VARIANT DETAILED INFORMATION**

**TYPE VARIANT NO. 16**

No.	Characteristics	Symbol	Limits		Unit	Remarks
			Min.	Max.		
1	Resonance Frequency	$f_L$	110.765		MHz	Swept
2	Reference Temperature	$T_o$	+23	+27	°C	
3	Overtone Order	-	5			AT cut
4	Load Capacitance	$C_L$	$\infty$		pF	
5	Rated Drive Level	$P_o$	0.1		mW	
6	Frequency Adjustment Tolerance	$\frac{\Delta f}{f}$	-5.0	+5.0	$10^{-6}$	At $T_o$ °C
7	Resonance Resistance	$R_r$	-	45	$\Omega$	At $T_o$ °C
8	Frequency Variation with Temperature over $T_{op}$	$\frac{\Delta f}{f}$	-10	+10	$10^{-6}$	From frequency measured at $T_o$ °C
9	Resistance Variation with Temperature over $T_{op}$	$\frac{\Delta R}{R}$	-10	+10	%	From resistance measured at $T_o$ °C
10	Operating Temperature Range	$T_{op}$	-25	+70	°C	
11	Frequency variation with Drive Level	$\frac{\Delta f}{f}$	Not applicable		$10^{-6}$	
12	Resistance variation with Drive Level	$\frac{\Delta R}{R}$	Not applicable		%	
13	Motional Inductance	$L_1$	4.5	5.5	mH	
14	Motional Capacitance	$C_1$	Not applicable		fF	
15	Static Capacitance	$C_o$	-	3.0	pF	
16	Q Factor	Q	80 000	-	-	
17	Ratio of Unwanted: Response Resistance to Resonance Resistance or Response Impedance to Resonance Resistance	$R_p/R$ $ Z_p /R$	2:1	-		In the frequency range: $f_r - 50\text{kHz}$ to $f_r + 50\text{kHz}$
18	Ageing	$\frac{\Delta f}{f}$	-0.5 -1.0	+0.5 +1.0	$10^{-6}$	First year after burn-in. Over 5 years
19	Terminal Length	L	Figure 2		mm	



**TABLE 1(a) - TYPE VARIANT DETAILED INFORMATION**

**TYPE VARIANT NO. 17**

No.	Characteristics	Symbol	Limits		Unit	Remarks
			Min.	Max.		
1	Resonance Frequency	$f_L$	27.5		MHz	
2	Reference Temperature	$T_0$	+23	+27	°C	
3	Overtone Order	-	Fundamental			
4	Load Capacitance	$C_L$	30		pF	
5	Rated Drive Level	$P_0$	0.1		mW	
6	Frequency Adjustment Tolerance	$\frac{\Delta f}{f}$	-10	+10	$10^{-6}$	At $T_0$ °C
7	Resonance Resistance	$R_r$	-	20	$\Omega$	At $T_0$ °C
8	Frequency Variation with Temperature over $T_{op}$	$\frac{\Delta f}{f}$	-10	+10	$10^{-6}$	From frequency measured at $T_0$ °C
9	Resistance Variation with Temperature over $T_{op}$	$\frac{\Delta R}{R}$	-10	+10	%	From resistance measured at $T_0$ °C
10	Operating Temperature Range	$T_{op}$	-20	+50	°C	
11	Frequency variation with Drive Level	$\frac{\Delta f}{f}$	Not applicable		$10^{-6}$	
12	Resistance variation with Drive Level	$\frac{\Delta R}{R}$	Not applicable		%	
13	Motional Inductance	$L_1$	Not applicable		mH	
14	Motional Capacitance	$C_1$	Not applicable		fF	
15	Static Capacitance	$C_0$	-	5.0	pF	
16	Q Factor	Q	80 000	-	-	
17	Ratio of Unwanted: Response Resistance to Resonance Resistance or Response Impedance to Resonance Resistance	$R_p/R$ $ Z_p /R$	2:1	-		In the frequency range: $f_L$ -10% to $f_L$ +10%
18	Ageing	$\frac{\Delta f}{f}$	-10	+10	$10^{-6}$	Over 10 years
19	Terminal Length	L	Figure 2		mm	

**TABLE 1(a) - TYPE VARIANT DETAILED INFORMATION**

**TYPE VARIANT NO. 18**

No.	Characteristics	Symbol	Limits		Unit	Remarks
			Min.	Max.		
1	Resonance Frequency	$f_r$	98.852381		MHz	
2	Reference Temperature	$T_o$	+20	+30	°C	
3	Overtone Order	-	5			
4	Load Capacitance	$C_L$	$\infty$		pF	
5	Rated Drive Level	$P_o$	0.1		mW	
6	Frequency Adjustment Tolerance	$\frac{\Delta f}{f}$	-5.0	+5.0	$10^{-6}$	At $T_o$ °C
7	Resonance Resistance	$R_r$	-	50	$\Omega$	At $T_o$ °C
8	Frequency Variation with Temperature over $T_{op}$	$\frac{\Delta f}{f}$	-9.0	+9.0	$10^{-6}$	From frequency measured at $T_o$ °C
9	Resistance Variation with Temperature over $T_{op}$	$\frac{\Delta R}{R}$	-20	+20	%	From resistance measured at $T_o$ °C
10	Operating Temperature Range	$T_{op}$	-25	+70	°C	
11	Frequency variation with Drive Level	$\frac{\Delta f}{f}$	Not applicable		$10^{-6}$	
12	Resistance variation with Drive Level	$\frac{\Delta R}{R}$	Not applicable		%	
13	Motional Inductance	$L_1$	6.5	-	mH	
14	Motional Capacitance	$C_1$	Not applicable		fF	
15	Static Capacitance	$C_o$	-	5.0	pF	
16	Q Factor	Q	90 000	-	-	
17	Ratio of Unwanted: Response Resistance to Resonance Resistance or Response Impedance to Resonance Resistance	$R_p/R$ $ Z_p /R$	2:1	-		In the frequency range: $f_r -10\%$ to $f_r +10\%$
18	Ageing	$\frac{\Delta f}{f}$	-3.0 -5.0	+3.0 +5.0	$10^{-6}$	After burn-in, first year. Over 10 years
19	Terminal Length	L	Figure 2		mm	

**TABLE 1(a) - TYPE VARIANT DETAILED INFORMATION**

**TYPE VARIANT NO. 19**

No.	Characteristics	Symbol	Limits		Unit	Remarks
			Min.	Max.		
1	Resonance Frequency	$f_r$	92.846032		MHz	
2	Reference Temperature	$T_o$	+20	+30	°C	
3	Overtone Order	-	5			
4	Load Capacitance	$C_L$	$\infty$		pF	
5	Rated Drive Level	$P_o$	0.1		mW	
6	Frequency Adjustment Tolerance	$\frac{\Delta f}{f}$	-5.0	+5.0	$10^{-6}$	At $T_o$ °C
7	Resonance Resistance	$R_r$	-	50	$\Omega$	At $T_o$ °C
8	Frequency Variation with Temperature over $T_{op}$	$\frac{\Delta f}{f}$	-9.0	+9.0	$10^{-6}$	From frequency measured at $T_o$ °C
9	Resistance Variation with Temperature over $T_{op}$	$\frac{\Delta R}{R}$	-20	+20	%	From resistance measured at $T_o$ °C
10	Operating Temperature Range	$T_{op}$	-25	+70	°C	
11	Frequency variation with Drive Level	$\frac{\Delta f}{f}$	Not applicable		$10^{-6}$	
12	Resistance variation with Drive Level	$\frac{\Delta R}{R}$	Not applicable		%	
13	Motional Inductance	$L_1$	6.5	-	mH	
14	Motional Capacitance	$C_1$	Not applicable		fF	
15	Static Capacitance	$C_o$	-	5.0	pF	
16	Q Factor	Q	90 000	-	-	
17	Ratio of Unwanted: Response Resistance to Resonance Resistance or Response Impedance to Resonance Resistance	$R_p/R$ or $ Z_{pl}/R$	2:1	-		In the frequency range: $f_r - 10\%$ to $f_r + 10\%$
18	Ageing	$\frac{\Delta f}{f}$	-3.0 -5.0	+3.0 +5.0	$10^{-6}$	After burn-in, first year. Over 10 years
19	Terminal Length	L	Figure 2		mm	

**TABLE 1(a) - TYPE VARIANT DETAILED INFORMATION**

**TYPE VARIANT NO. 20**

No.	Characteristics	Symbol	Limits		Unit	Remarks
			Min.	Max.		
1	Resonance Frequency	$f_r$	88.134921		MHz	PQ swept
2	Reference Temperature	$T_0$	+ 20	+ 30	°C	
3	Overtone Order	-	5			
4	Load Capacitance	$C_L$	$\infty$		pF	
5	Rated Drive Level	$P_0$	0.1		mW	
6	Frequency Adjustment Tolerance	$\frac{\Delta f}{f}$	-5.0	+ 5.0	$10^{-6}$	At $T_0$ °C
7	Resonance Resistance	$R_r$	-	50	$\Omega$	At $T_0$ °C
8	Frequency Variation with Temperature over $T_{op}$	$\frac{\Delta f}{f}$	-9.0	+ 9.0	$10^{-6}$	From frequency measured at $T_0$ °C
9	Resistance Variation with Temperature over $T_{op}$	$\frac{\Delta R}{R}$	-20	+ 20	%	From resistance measured at $T_0$ °C
10	Operating Temperature Range	$T_{op}$	-25	+ 70	°C	
11	Frequency variation with Drive Level	$\frac{\Delta f}{f}$	Not applicable		$10^{-6}$	
12	Resistance variation with Drive Level	$\frac{\Delta R}{R}$	Not applicable		%	
13	Motional Inductance	$L_1$	6.5	-	mH	
14	Motional Capacitance	$C_1$	Not applicable		fF	
15	Static Capacitance	$C_0$	-	7.0	pF	
16	Q Factor	Q	70 000	-	-	
17	Ratio of Unwanted: Response Resistance to Resonance Resistance or Response Impedance to Resonance Resistance	$R_p/R$ $ Z_{pl}/R$	2:1	-		In the frequency range: $f_r - 8\ 000\text{kHz}$ to $f_r + 8\ 000\text{kHz}$
18	Ageing	$\frac{\Delta f}{f}$	-3.0 -5.0	+ 3.0 + 5.0	$10^{-6}$	After burn-in, first year. Over 10 years
19	Terminal Length	L	Figure 2		mm	

**TABLE 1(a) - TYPE VARIANT DETAILED INFORMATION**

TYPE VARIANT NO. 21

No.	Characteristics	Symbol	Limits		Unit	Remarks
			Min.	Max.		
1	Resonance Frequency	$f_r$	84.0		MHz	
2	Reference Temperature	$T_o$	+65	+75	°C	Turn-on Point
3	Overtone Order	-	3			
4	Load Capacitance	$C_L$	$\infty$		pF	
5	Rated Drive Level	$P_o$	0.1		mW	
6	Frequency Adjustment Tolerance	$\frac{\Delta f}{f}$	-5.0	+5.0	$10^{-6}$	At $T_o$ °C
7	Resonance Resistance	$R_r$	-	40	$\Omega$	At $T_o$ °C
8	Frequency Variation with Temperature over $T_{op}$	$\frac{\Delta f}{f}$	Not applicable		$10^{-6}$	
9	Resistance Variation with Temperature over $T_{op}$	$\frac{\Delta R}{R}$	-20	+20	%	From resistance measured at $T_o$ °C
10	Operating Temperature Range	$T_{op}$	-20	+80	°C	
11	Frequency variation with Drive Level	$\frac{\Delta f}{f}$	Not applicable		$10^{-6}$	
12	Resistance variation with Drive Level	$\frac{\Delta R}{R}$	Not applicable		%	
13	Motional Inductance	$L_1$	2.0	-	mH	
14	Motional Capacitance	$C_1$	Not applicable		fF	
15	Static Capacitance	$C_o$	-	5.0	pF	
16	Q Factor	Q	70 000	-	-	
17	Ratio of Unwanted: Response Resistance to Resonance Resistance or Response Impedance to Resonance Resistance	$R_p/R$ or $ Z_p /R$	2:1	-		In the frequency range: $f_r - 8\ 000\text{kHz}$ to $f_r + 8\ 000\text{kHz}$
18	Ageing	$\frac{\Delta f}{f}$	-5.0	+5.0	$10^{-6}$	After burn-in and over 10 years
19	Terminal Length	L	Figure 2		mm	

**TABLE 1(a) - TYPE VARIANT DETAILED INFORMATION**

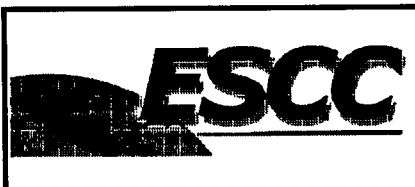
TYPE VARIANT NO. 22

No.	Characteristics	Symbol	Limits		Unit	Remarks
			Min.	Max.		
1	Resonance Frequency	$f_L$	15.0		MHz	
2	Reference Temperature	$T_o$	+23	+27	°C	
3	Overtone Order	-	Fundamental			
4	Load Capacitance	$C_L$	18	32	pF	
5	Rated Drive Level	$P_o$	0.1		mW	
6	Frequency Adjustment Tolerance	$\frac{\Delta f}{f}$	Not applicable		$10^{-6}$	
7	Resonance Resistance	$R_r$	-	100	$\Omega$	Over $T_{op}$ °C
8	Frequency Variation with Temperature over $T_{op}$	$\frac{\Delta f}{f}$	-40	+40	$10^{-6}$	From frequency measured at $T_o$ °C
9	Resistance Variation with Temperature over $T_{op}$	$\frac{\Delta R}{R}$	Not applicable		%	From resistance measured at $T_o$ °C
10	Operating Temperature Range	$T_{op}$	-55	+105	°C	
11	Frequency variation with Drive Level	$\frac{\Delta f}{f}$	Not applicable		$10^{-6}$	
12	Resistance variation with Drive Level	$\frac{\Delta R}{R}$	Not applicable		%	
13	Motional Inductance	$L_1$	Not applicable		mH	
14	Motional Capacitance	$C_1$	Not applicable		fF	
15	Static Capacitance	$C_o$	-	7.0	pF	
16	Q Factor	Q	80 000	-	-	
17	Ratio of Unwanted: Response Resistance to Resonance Resistance or Response Impedance to Resonance Resistance	$R_p/R$ $ Z_p /R$	2:1	-		In the frequency range: $f_L - 200\text{kHz}$ to $f_L + 200\text{kHz}$
18	Ageing	$\frac{\Delta f}{f}$	-2.0	+2.0	$10^{-6}$	After burn-in, per year
19	Terminal Length	L	Figure 2		mm	

**TABLE 1(a) - TYPE VARIANT DETAILED INFORMATION**

TYPE VARIANT NO. 23

No.	Characteristics	Symbol	Limits		Unit	Remarks
			Min.	Max.		
1	Resonance Frequency	$f_r$	40.0		MHz	Swept
2	Reference Temperature	$T_o$	+36	+44	°C	
3	Overtone Order	-	3			
4	Load Capacitance	$C_L$	$\infty$		pF	
5	Rated Drive Level	$P_o$	0.1		mW	
6	Frequency Adjustment Tolerance	$\frac{\Delta f}{f}$	-10	+10	$10^{-6}$	At $T_o$ °C
7	Resonance Resistance	$R_r$	10	25	$\Omega$	Over $T_{op}$ °C
8	Frequency Variation with Temperature over $T_{op}$	$\frac{\Delta f}{f}$	-15	+15	$10^{-6}$	From frequency measured at $T_o$ °C
9	Resistance Variation with Temperature over $T_{op}$	$\frac{\Delta R}{R}$	-10	+10	%	From resistance measured at $T_o$ °C
10	Operating Temperature Range	$T_{op}$	0	+90	°C	
11	Frequency variation with Drive Level	$\frac{\Delta f}{f}$	-1.0	+1.0	$10^{-6}$	From $P_{S1} = 0.05mW$ to $P_{S2} = 0.2mW$
12	Resistance variation with Drive Level	$\frac{\Delta R}{R}$	Not applicable		%	
13	Motional Inductance	$L_1$	5.0	-	mH	
14	Motional Capacitance	$C_1$	Not applicable		fF	
15	Static Capacitance	$C_o$	-	5.0	pF	
16	Q Factor	Q	50 000	-	-	
17	Ratio of Unwanted: Response Resistance to Resonance Resistance or Response Resistance Response Resistance	$R_p/R$	4:1	-	-	In the frequency range: $f_r - 50kHz$ to $f_r + 50kHz$
		$R_p$	2.5	-	$\Omega$	Fundamental Overtone 5
		$R_p$	25	-	$\Omega$	
18	Ageing	$\frac{\Delta f}{f}$	-5.0	+5.0	$10^{-6}$	After burn-in over 5 years
19	Terminal Length	L	Figure 2		mm	



**TABLE 1(a) - TYPE VARIANT DETAILED INFORMATION**

TYPE VARIANT NO. 24

No.	Characteristics	Symbol	Limits		Unit	Remarks
			Min.	Max.		
1	Resonance Frequency	$f_r$	29.6296		MHz	
2	Reference Temperature	$T_0$	+36	+44	°C	
3	Overtone Order	-	Fundamental			
4	Load Capacitance	$C_L$	$\infty$		pF	
5	Rated Drive Level	$P_0$	0.1		mW	
6	Frequency Adjustment Tolerance	$\frac{\Delta f}{f}$	-10	+10	$10^{-6}$	At $T_0$ °C
7	Resonance Resistance	$R_r$	2.5	15	$\Omega$	Over $T_{op}$ °C and drive level
8	Frequency Variation with Temperature over $T_{op}$	$\frac{\Delta f}{f}$	-30	+30	$10^{-6}$	From frequency measured at $T_0$ °C
9	Resistance Variation with Temperature over $T_{op}$	$\frac{\Delta R}{R}$	-10	+10	%	From resistance measured at $T_0$ °C If $R < 10\Omega$
			-1.5	+1.5	$\Omega$	
10	Operating Temperature Range	$T_{op}$	0	+90	°C	
11	Frequency variation with Drive Level	$\frac{\Delta f}{f}$	-1.0	+1.0	$10^{-6}$	From $P_{S1} = 0.025mW$ to $P_{S2} = 0.2mW$
12	Resistance variation with Drive Level	$\frac{\Delta R}{R}$	Not applicable		%	
13	Motional Inductance	$L_1$	2.8	-	mH	
14	Motional Capacitance	$C_1$	Not applicable		fF	
15	Static Capacitance	$C_0$	-	5.0	pF	
16	Q Factor	Q	60 000	-	-	
17	Ratio of Unwanted: Response Resistance to Resonance Resistance	$R_p/R$	4:1	-	-	In the frequency range: $f_r - 50kHz$ to $f_r + 50kHz$
	Response Resistance	$R_p$	30	-	$\Omega$	Overtone 3
18	Ageing	$\frac{\Delta f}{f}$	-3.0	+3.0	$10^{-6}$	Per year after burn-in
19	Terminal Length	L	Figure 2		mm	

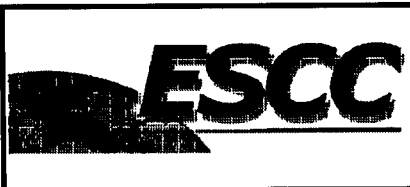




**TABLE 1(a) - TYPE VARIANT DETAILED INFORMATION**

TYPE VARIANT NO. 25

No.	Characteristics	Symbol	Limits		Unit	Remarks
			Min.	Max.		
1	Resonance Frequency	$f_r$	32.0		MHz	Synthetic swept, Premium Q
2	Reference Temperature	$T_o$	+23	+27	°C	Inflection temp. point
3	Overtone Order	-	3			A/T cut
4	Load Capacitance	$C_L$	$\infty$		pF	
5	Rated Drive Level	$P_o$	0.1		mW	
6	Frequency Adjustment Tolerance	$\frac{\Delta f}{f}$	-10	+10	$10^{-6}$	At $T_o$ °C
7	Resonance Resistance	$R_r$	-	30	$\Omega$	Over $T_{op}$ °C
8	Frequency Variation with Temperature over $T_{op}$	$\frac{\Delta f}{f}$	-10	+10	$10^{-6}$	From frequency measured at $T_o$ °C One measurement each 2.5°C
9	Resistance Variation with Temperature over $T_{op}$	$\frac{\Delta R}{R}$	-10	+10	%	From resistance measured at $T_o$ °C
10	Operating Temperature Range	$T_{op}$	-20	+70	°C	
11	Frequency variation with Drive Level	$\frac{\Delta f}{f}$	Not applicable		$10^{-6}$	
12	Resistance variation with Drive Level	$\frac{\Delta R}{R}$	Not applicable		%	
13	Motional Inductance	$L_1$	Not applicable		mH	
14	Motional Capacitance	$C_1$	Not applicable		fF	
15	Static Capacitance	$C_o$	-	7.0	pF	
16	Q Factor	Q	Not applicable		-	
17	Ratio of Unwanted: Response Resistance to Resonance Resistance or Response Impedance to Resonance Resistance	$R_p/R$ or $ Z_p /R$	2:1	-		In the frequency range: $f_r -10\%$ to $f_r + 10\%$
18	Ageing	$\frac{\Delta f}{f}$	-5.0	+5.0	$10^{-6}$	After burn-in and per year
19	Terminal Length	L	Figure 2		mm	



**TABLE 1(a) - TYPE VARIANT DETAILED INFORMATION**

TYPE VARIANT NO. 26

No.	Characteristics	Symbol	Limits		Unit	Remarks
			Min.	Max.		
1	Resonance Frequency	$f_r$	14.7456		MHz	
2	Reference Temperature	$T_o$	+23	+27	°C	
3	Overtone Order	-	Fundamental			A/T cut
4	Load Capacitance	$C_L$	$\infty$		pF	
5	Rated Drive Level	$P_o$	0.1		mW	
6	Frequency Adjustment Tolerance	$\frac{\Delta f}{f}$	-10	+10	$10^{-6}$	At $T_o$ °C
7	Resonance Resistance	$R_r$	3.0	15	$\Omega$	Over $T_{op}$ °C
8	Frequency Variation with Temperature over $T_{op}$	$\frac{\Delta f}{f}$	-25	+25	$10^{-6}$	From frequency measured at $T_o$ °C
9	Resistance Variation with Temperature over $T_{op}$	$\frac{\Delta R}{R}$	-1.0	+1.0	$\Omega$	From resistance measured at $T_o$ °C
10	Operating Temperature Range	$T_{op}$	-55	+105	°C	
11	Frequency variation with Drive Level	$\frac{\Delta f}{f}$	Not applicable		$10^{-6}$	
12	Resistance variation with Drive Level	$\frac{\Delta R}{R}$	Not applicable		%	
13	Motional Inductance	$L_1$	Not applicable		mH	
14	Motional Capacitance	$C_1$	Not applicable		fF	
15	Static Capacitance	$C_o$	-	7.0	pF	
16	Q Factor	Q	80 000	-	-	
17	Ratio of Unwanted: Response Resistance to Resonance Resistance or Response Impedance to Resonance Resistance	$R_p/R$ $ Z_p /R$	2:1	-		In the frequency range: $f_r - 200\text{kHz}$ to $f_r + 200\text{kHz}$
18	Ageing	$\frac{\Delta f}{f}$	-2.0	+2.0	$10^{-6}$	Per year after burn-in
19	Terminal Length	L	Figure 2		mm	



**TABLE 1(a) - TYPE VARIANT DETAILED INFORMATION**

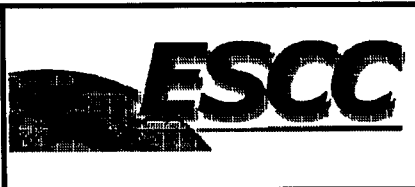
TYPE VARIANT NO. 27

No.	Characteristics	Symbol	Limits		Unit	Remarks
			Min.	Max.		
1	Resonance Frequency	$f_L$	12.25		MHz	Parallel resonance
2	Reference Temperature	$T_o$	+23	+27	°C	
3	Overtone Order	-	Fundamental			A/T cut
4	Load Capacitance	$C_L$	32		pF	
5	Rated Drive Level	$P_o$	0.5		mW	
6	Frequency Adjustment Tolerance	$\frac{\Delta f}{f}$	-10	+10	$10^{-6}$	At $T_o$ °C
7	Resonance Resistance	$R_r$	-	25	$\Omega$	At $T_o$ °C
8	Frequency Variation with Temperature over $T_{op}$	$\frac{\Delta f}{f}$	-10	+10	$10^{-6}$	From frequency measured at $T_o$ °C
9	Resistance Variation with Temperature over $T_{op}$	$\frac{\Delta R}{R}$	-50	+50	%	From resistance measured at $T_o$ °C
10	Operating Temperature Range	$T_{op}$	-30	+70	°C	
11	Frequency variation with Drive Level	$\frac{\Delta f}{f}$	Not applicable		$10^{-6}$	
12	Resistance variation with Drive Level	$\frac{\Delta R}{R}$	-25	+25	%	From $P_{S1} = 0.05mW$ to $P_{S2} = 0.2mW$
13	Motional Inductance	$L_1$	27	33	mH	
14	Motional Capacitance	$C_1$	5.04	6.16	fF	
15	Static Capacitance	$C_o$	-	4.0	pF	
16	Q Factor	Q	30 000	-	-	
17	Ratio of Unwanted: Response Resistance to Resonance Resistance or Response Impedance to Resonance Resistance	$R_p/R$ or $ Z_p /R$	2:1	-		In the frequency range: $f_L - 500kHz$ to $f_L + 500kHz$
18	Ageing	$\frac{\Delta f}{f}$	-10	+10	$10^{-6}$	After burn-in over 10 years
19	Terminal Length	L	Figure 2		mm	

**TABLE 1(a) - TYPE VARIANT DETAILED INFORMATION**

TYPE VARIANT NO. 28

No.	Characteristics	Symbol	Limits		Unit	Remarks
			Min.	Max.		
1	Resonance Frequency	$f_L$	4.096		MHz	
2	Reference Temperature	$T_o$	+ 22	+ 28	°C	
3	Overtone Order	-	Fundamental			
4	Load Capacitance	$C_L$	25		pF	
5	Rated Drive Level	$P_o$	0.2		mW	
6	Frequency Adjustment Tolerance	$\frac{\Delta f}{f}$	-10	+ 10	$10^{-6}$	At $T_o$ °C
7	Resonance Resistance	$R_r$	-	75	$\Omega$	Over $T_{op}$ °C
8	Frequency Variation with Temperature over $T_{op}$	$\frac{\Delta f}{f}$	-50	+ 50	$10^{-6}$	From frequency measured at $T_o$ °C
9	Resistance Variation with Temperature over $T_{op}$	$\frac{\Delta R}{R}$	Not applicable		%	
10	Operating Temperature Range	$T_{op}$	-55	+ 100	°C	
11	Frequency variation with Drive Level	$\frac{\Delta f}{f}$	Not applicable		$10^{-6}$	
12	Resistance variation with Drive Level	$\frac{\Delta R}{R}$	Not applicable		%	
13	Motional Inductance	$L_1$	313	348	mH	
14	Motional Capacitance	$C_1$	4.34	4.82	fF	
15	Static Capacitance	$C_o$	1.5	2.0	pF	
16	Q Factor	Q	130 000	-	-	
17	Ratio of Unwanted: Response Resistance to Resonance Resistance or Response Impedance to Resonance Resistance	$R_p/R$  $ Z_p /R$	10:1	-		In the frequency range: $f_L$ -100kHz to $f_L$ + 100kHz
18	Ageing	$\frac{\Delta f}{f}$	-10	+ 10	$10^{-6}$	2 years at rated drive level
19	Terminal Length	L	Figure 2		mm	



**TABLE 1(a) - TYPE VARIANT DETAILED INFORMATION**

TYPE VARIANT NO. 29

No.	Characteristics	Symbol	Limits		Unit	Remarks
			Min.	Max.		
1	Resonance Frequency	$f_r$	31.999305		MHz	
2	Reference Temperature	$T_o$	+23	+27	°C	
3	Overtone Order	-	3			
4	Load Capacitance	$C_L$	$\infty$		pF	
5	Rated Drive Level	$P_o$	0.1		mW	
6	Frequency Adjustment Tolerance	$\frac{\Delta f}{f}$	-10	+10	$10^{-6}$	At $T_o$ °C
7	Resonance Resistance	$R_r$	-	50	$\Omega$	At $T_o$ °C
8	Frequency Variation with Temperature over $T_{op}$	$\frac{\Delta f}{f}$	-10	+10	$10^{-6}$	From frequency measured at $T_o$ °C
9	Resistance Variation with Temperature over $T_{op}$	$\frac{\Delta R}{R}$	-10	+10	%	From resistance measured at $T_o$ °C
10	Operating Temperature Range	$T_{op}$	-20	+60	°C	
11	Frequency variation with Drive Level	$\frac{\Delta f}{f}$	Not applicable		$10^{-6}$	
12	Resistance variation with Drive Level	$\frac{\Delta R}{R}$	Not applicable		%	
13	Motional Inductance	$L_1$	Not applicable		mH	
14	Motional Capacitance	$C_1$	Not applicable		fF	
15	Static Capacitance	$C_o$	-	7.0	pF	
16	Q Factor	Q	50 000	-	-	
17	Ratio of Unwanted: Response Resistance to Resonance Resistance or Response Impedance to Resonance Resistance	$R_p/R$ or $ Z_p /R$	2:1	-		In the frequency range: $f_r - 200\text{kHz}$ to $f_r + 200\text{kHz}$
18	Ageing	$\frac{\Delta f}{f}$	-1.0	+1.0	$10^{-6}$	After burn-in per year.
19	Terminal Length	L	Figure 2		mm	



**TABLE 1(a) - TYPE VARIANT DETAILED INFORMATION**

TYPE VARIANT NO. 30

No.	Characteristics	Symbol	Limits		Unit	Remarks
			Min.	Max.		
1	Resonance Frequency	$f_r$	74.801912		MHz	
2	Reference Temperature	$T_o$	+20	+30	°C	
3	Overtone Order	-	3			
4	Load Capacitance	$C_L$	$\infty$		pF	
5	Rated Drive Level	$P_o$	0.1		mW	
6	Frequency Adjustment Tolerance	$\frac{\Delta f}{f}$	-10	+10	$10^{-6}$	At $T_o$ °C
7	Resonance Resistance	$R_r$	-	50	$\Omega$	At $T_o$ °C
8	Frequency Variation with Temperature over $T_{op}$	$\frac{\Delta f}{f}$	-9.0	+9.0	$10^{-6}$	From frequency measured at $T_o$ °C
9	Resistance Variation with Temperature over $T_{op}$	$\frac{\Delta R}{R}$	-20	+20	%	From resistance measured at $T_o$ °C
10	Operating Temperature Range	$T_{op}$	-25	+70	°C	
11	Frequency variation with Drive Level	$\frac{\Delta f}{f}$	Not applicable		$10^{-6}$	
12	Resistance variation with Drive Level	$\frac{\Delta R}{R}$	Not applicable		%	
13	Motional Inductance	$L_1$	6.5	-	mH	
14	Motional Capacitance	$C_1$	Not applicable		fF	
15	Static Capacitance	$C_o$	-	5.0	pF	
16	Q Factor	Q	90 000	-	-	
17	Ratio of Unwanted: Response Resistance to Resonance Resistance or Response Impedance to Resonance Resistance	$R_p/R$ or $ Z_p /R$	2:1	-		In the frequency range: $f_r - 7482\text{kHz}$ to $f_r + 7482\text{kHz}$
18	Ageing	$\frac{\Delta f}{f}$	-3.0 -5.0	+3.0 +5.0	$10^{-6}$	After burn-in, first year. Over 10 years
19	Terminal Length	L	Figure 2		mm	

**TABLE 1(a) - TYPE VARIANT DETAILED INFORMATION**

TYPE VARIANT NO. 31

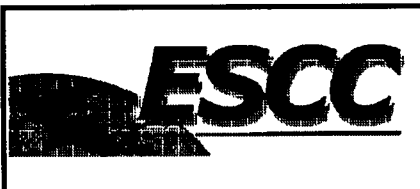
No.	Characteristics	Symbol	Limits		Unit	Remarks
			Min.	Max.		
1	Resonance Frequency	$f_r$	78.217213		MHz	
2	Reference Temperature	$T_o$	+20	+30	°C	
3	Overtone Order	-	3			
4	Load Capacitance	$C_L$	$\infty$		pF	
5	Rated Drive Level	$P_o$	0.1		mW	
6	Frequency Adjustment Tolerance	$\frac{\Delta f}{f}$	-10	+10	$10^{-6}$	At $T_o$ °C
7	Resonance Resistance	$R_r$	-	50	$\Omega$	At $T_o$ °C
8	Frequency Variation with Temperature over $T_{op}$	$\frac{\Delta f}{f}$	-9.0	+9.0	$10^{-6}$	From frequency measured at $T_o$ °C
9	Resistance Variation with Temperature over $T_{op}$	$\frac{\Delta R}{R}$	-20	+20	%	From resistance measured at $T_o$ °C
10	Operating Temperature Range	$T_{op}$	-20	+70	°C	
11	Frequency variation with Drive Level	$\frac{\Delta f}{f}$	Not applicable		$10^{-6}$	
12	Resistance variation with Drive Level	$\frac{\Delta R}{R}$	Not applicable		%	
13	Motional Inductance	$L_1$	6.5	-	mH	
14	Motional Capacitance	$C_1$	Not applicable		fF	
15	Static Capacitance	$C_o$	-	5.0	pF	
16	Q Factor	Q	90 000	-	-	
17	Ratio of Unwanted: Response Resistance to Resonance Resistance or Response Impedance to Resonance Resistance	$R_p/R$ or $ Z_p /R$	2:1	-		In the frequency range: $f_r - 7822\text{kHz}$ to $f_r + 7822\text{kHz}$
18	Ageing	$\frac{\Delta f}{f}$	-3.0 -5.0	+3.0 +5.0	$10^{-6}$	After burn-in, first year. Over 10 years
19	Terminal Length	L	Figure 2		mm	

**TABLE 1(a) - TYPE VARIANT DETAILED INFORMATION**

TYPE VARIANT NO. 32

No.	Characteristics	Symbol	Limits		Unit	Remarks
			Min.	Max.		
1	Resonance Frequency	$f_r$	81.66667		MHz	
2	Reference Temperature	$T_o$	+ 65	+ 75	°C	
3	Overtone Order	-	3			
4	Load Capacitance	$C_L$	$\infty$		pF	
5	Rated Drive Level	$P_o$	0.1		mW	
6	Frequency Adjustment Tolerance	$\frac{\Delta f}{f}$	-10	+ 10	$10^{-6}$	At $T_o$ °C
7	Resonance Resistance	$R_r$	-	40	$\Omega$	At $T_o$ °C
8	Frequency Variation with Temperature over $T_{op}$	$\frac{\Delta f}{f}$	Not applicable		$10^{-6}$	
9	Resistance Variation with Temperature over $T_{op}$	$\frac{\Delta R}{R}$	-20	+ 20	%	From resistance measured at $T_o$ °C
10	Operating Temperature Range	$T_{op}$	-20	+ 70	°C	
11	Frequency variation with Drive Level	$\frac{\Delta f}{f}$	Not applicable		$10^{-6}$	
12	Resistance variation with Drive Level	$\frac{\Delta R}{R}$	Not applicable		%	
13	Motional Inductance	$L_1$	2.0	-	mH	
14	Motional Capacitance	$C_1$	Not applicable		fF	
15	Static Capacitance	$C_o$	-	5.0	pF	
16	Q Factor	Q	70 000	-	-	
17	Ratio of Unwanted: Response Resistance to Resonance Resistance or Response Impedance to Resonance Resistance	$R_p/R$ or $ Z_p /R$	2:1	-		In the frequency range: $f_r - 8166\text{kHz}$ to $f_r + 8166\text{kHz}$
18	Ageing	$\frac{\Delta f}{f}$	-3.0 -5.0	+ 3.0 + 5.0	$10^{-6}$	After burn-in, first year. Over 10 years
19	Terminal Length	L	Figure 2		mm	

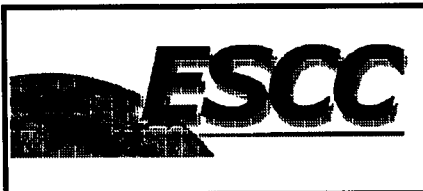




**TABLE 1(a) - TYPE VARIANT DETAILED INFORMATION**

TYPE VARIANT NO. 33

No.	Characteristics	Symbol	Limits		Unit	Remarks
			Min.	Max.		
1	Resonance Frequency	$f_r$	81.800766		MHz	
2	Reference Temperature	$T_o$	+65	+75	°C	
3	Overtone Order	-	3			
4	Load Capacitance	$C_L$	$\infty$		pF	
5	Rated Drive Level	$P_o$	0.1		mW	
6	Frequency Adjustment Tolerance	$\frac{\Delta f}{f}$	-10	+10	$10^{-6}$	At $T_o$ °C
7	Resonance Resistance	$R_r$	-	40	$\Omega$	At $T_o$ °C
8	Frequency Variation with Temperature over $T_{op}$	$\frac{\Delta f}{f}$	Not applicable		$10^{-6}$	
9	Resistance Variation with Temperature over $T_{op}$	$\frac{\Delta R}{R}$	-20	+20	%	From resistance measured at $T_o$ °C
10	Operating Temperature Range	$T_{op}$	-20	+80	°C	
11	Frequency variation with Drive Level	$\frac{\Delta f}{f}$	Not applicable		$10^{-6}$	
12	Resistance variation with Drive Level	$\frac{\Delta R}{R}$	Not applicable		%	
13	Motional Inductance	$L_1$	2.0	-	mH	
14	Motional Capacitance	$C_1$	Not applicable		fF	
15	Static Capacitance	$C_o$	-	5.0	pF	
16	Q Factor	Q	70 000	-	-	
17	Ratio of Unwanted: Response Resistance to Resonance Resistance or Response Impedance to Resonance Resistance	$R_p/R$ or $ Z_p /R$	2:1	-		In the frequency range: $f_r - 8180\text{kHz}$ to $f_r + 8180\text{kHz}$
18	Ageing	$\frac{\Delta f}{f}$	-3.0 -5.0	+3.0 +5.0	$10^{-6}$	After burn-in, first year. Over 10 years
19	Terminal Length	L	Figure 2		mm	



**TABLE 1(a) - TYPE VARIANT DETAILED INFORMATION**

TYPE VARIANT NO. 34

No.	Characteristics	Symbol	Limits		Unit	Remarks
			Min.	Max.		
1	Resonance Frequency	$f_r$	90.869921		MHz	
2	Reference Temperature	$T_0$	+20	+30	°C	
3	Overtone Order	-	5			
4	Load Capacitance	$C_L$	$\infty$		pF	
5	Rated Drive Level	$P_0$	0.1		mW	
6	Frequency Adjustment Tolerance	$\frac{\Delta f}{f}$	-10	+10	$10^{-6}$	At $T_0$ °C
7	Resonance Resistance	$R_r$	-	50	$\Omega$	At $T_0$ °C
8	Frequency Variation with Temperature over $T_{op}$	$\frac{\Delta f}{f}$	-9.0	+9.0	$10^{-6}$	From frequency measured at $T_0$ °C
9	Resistance Variation with Temperature over $T_{op}$	$\frac{\Delta R}{R}$	-20	+20	%	From resistance measured at $T_0$ °C
10	Operating Temperature Range	$T_{op}$	-25	+70	°C	
11	Frequency variation with Drive Level	$\frac{\Delta f}{f}$	Not applicable		$10^{-6}$	
12	Resistance variation with Drive Level	$\frac{\Delta R}{R}$	Not applicable		%	
13	Motional Inductance	$L_1$	6.5	-	mH	
14	Motional Capacitance	$C_1$	Not applicable		fF	
15	Static Capacitance	$C_0$	-	3.0	pF	
16	Q Factor	Q	90 000	-	-	
17	Ratio of Unwanted: Response Resistance to Resonance Resistance or Response Impedance to Resonance Resistance	$R_p/R$ or $ Z_p /R$	2:1	-		In the frequency range: $f_r - 9000\text{kHz}$ to $f_r + 9000\text{kHz}$
18	Ageing	$\frac{\Delta f}{f}$	-5.0	+5.0	$10^{-6}$	After burn-in and 10 years
19	Terminal Length	L	Figure 2		mm	

**TABLE 1(a) - TYPE VARIANT DETAILED INFORMATION**

TYPE VARIANT NO. 35

No.	Characteristics	Symbol	Limits		Unit	Remarks
			Min.	Max.		
1	Resonance Frequency	$f_r$	85.412668		MHz	
2	Reference Temperature	$T_0$	+59	+71	°C	
3	Overtone Order	-	5			
4	Load Capacitance	$C_L$	$\infty$		pF	
5	Rated Drive Level	$P_0$	0.1		mW	
6	Frequency Adjustment Tolerance	$\frac{\Delta f}{f}$	-5.0	+5.0	$10^{-6}$	At $T_0$ °C
7	Resonance Resistance	$R_r$	-	45	$\Omega$	At $T_0$ °C
8	Frequency Variation with Temperature over $T_{op}$	$\frac{\Delta f}{f}$	-2.0	+2.0	$10^{-6}$	From frequency measured at $T_0$ °C
9	Resistance Variation with Temperature over $T_{op}$	$\frac{\Delta R}{R}$	-20	+20	%	From resistance measured at $T_0$ °C
10	Operating Temperature Range	$T_{op}$	-59	+71	°C	
11	Frequency variation with Drive Level	$\frac{\Delta f}{f}$	Not applicable		$10^{-6}$	
12	Resistance variation with Drive Level	$\frac{\Delta R}{R}$	Not applicable		%	
13	Motional Inductance	$L_1$	2.0	-	mH	
14	Motional Capacitance	$C_1$	Not applicable		fF	
15	Static Capacitance	$C_0$	-	7.0	pF	
16	Q Factor	Q	70 000	-	-	
17	Ratio of Unwanted: Response Resistance to Resonance Resistance or Response Impedance to Resonance Resistance	$R_p/R$ or $ Z_p /R$	2:1	-		
18	Ageing	$\frac{\Delta f}{f}$	-1.0	+1.0	$10^{-6}$	After burn-in and 10 years
19	Terminal Length	L	Figure 2		mm	



**TABLE 1(a) - TYPE VARIANT DETAILED INFORMATION**

TYPE VARIANT NO. 36

No.	Characteristics	Symbol	Limits		Unit	Remarks
			Min.	Max.		
1	Resonance Frequency	$f_r$	140.0		MHz	
2	Reference Temperature	$T_o$	+23	+27	°C	
3	Overtone Order	-	5			
4	Load Capacitance	$C_L$	$\infty$		pF	
5	Rated Drive Level	$P_o$	0.1		mW	
6	Frequency Adjustment Tolerance	$\frac{\Delta f}{f}$	-10	+10	$10^{-6}$	At $T_o$ °C
7	Resonance Resistance	$R_r$	0	70	$\Omega$	At $T_o$ °C
8	Frequency Variation with Temperature over $T_{op}$	$\frac{\Delta f}{f}$	-15	+15	$10^{-6}$	From frequency measured at $T_o$ °C
9	Resistance Variation with Temperature over $T_{op}$	$\frac{\Delta R}{R}$	-20	+20	%	From resistance measured at $T_o$ °C
10	Operating Temperature Range	$T_{op}$	-20	+70	°C	
11	Frequency variation with Drive Level	$\frac{\Delta f}{f}$	Not applicable		$10^{-6}$	
12	Resistance variation with Drive Level	$\frac{\Delta R}{R}$	Not applicable		%	
13	Motional Inductance	$L_1$	Not applicable		mH	
14	Motional Capacitance	$C_1$	Not applicable		fF	
15	Static Capacitance	$C_o$	0	7.0	pF	
16	Q Factor	Q	70 000	-	-	
17	Ratio of Unwanted: Response Resistance to Resonance Resistance or Response Impedance to Resonance Resistance	$R_p/R$ or $ Z_p /R$	2:1	-		In the frequency range: $f_r - 200\text{kHz}$ to $f_r + 200\text{kHz}$
18	Ageing	$\frac{\Delta f}{f}$	-3.0	+3.0	$10^{-6}$	After burn-in, per year
19	Terminal Length	L	Figure 2		mm	

**TABLE 1(a) - TYPE VARIANT DETAILED INFORMATION**

TYPE VARIANT NO. 37

No.	Characteristics	Symbol	Limits		Unit	Remarks
			Min.	Max.		
1	Resonance Frequency	$f_r$	81.544502		MHz	
2	Reference Temperature	$T_o$	+62	+72	°C	
3	Overtone Order	-	3			
4	Load Capacitance	$C_L$	$\infty$		pF	
5	Rated Drive Level	$P_o$	0.1		mW	
6	Frequency Adjustment Tolerance	$\frac{\Delta f}{f}$	-10	+10	$10^{-6}$	At $T_o$ °C
7	Resonance Resistance	$R_r$	-	40	$\Omega$	At $T_o$ °C
8	Frequency Variation with Temperature over $T_{op}$	$\frac{\Delta f}{f}$	Not applicable		$10^{-6}$	
9	Resistance Variation with Temperature over $T_{op}$	$\frac{\Delta R}{R}$	-20	+20	%	From resistance measured at $T_o$ °C
			-2.0	+2.0	$\Omega$	
10	Operating Temperature Range	$T_{op}$	-20	+80	°C	
11	Frequency variation with Drive Level	$\frac{\Delta f}{f}$	Not applicable		$10^{-6}$	
12	Resistance variation with Drive Level	$\frac{\Delta R}{R}$	Not applicable		%	
13	Motional Inductance	$L_1$	2.0	-	mH	
14	Motional Capacitance	$C_1$	Not applicable		fF	
15	Static Capacitance	$C_o$	0	5.0	pF	
16	Q Factor	Q	70 000	-	-	
17	Ratio of Unwanted: Response Resistance to Resonance Resistance or Response Impedance to Resonance Resistance	$R_p/R$ or $ Z_p /R$	2:1	-		In the frequency range: $f_r - 8100\text{kHz}$ to $f_r + 8100\text{kHz}$
18	Ageing	$\frac{\Delta f}{f}$	-3.0	+3.0	$10^{-6}$	After burn-in, over 10 years
19	Terminal Length	L	Figure 2		mm	

**TABLE 1(a) - TYPE VARIANT DETAILED INFORMATION**

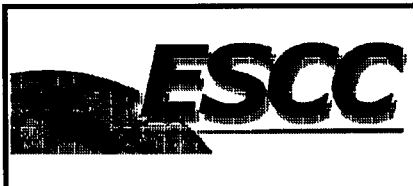
**TYPE VARIANT NO. 38**

No.	Characteristics	Symbol	Limits		Unit	Remarks
			Min.	Max.		
1	Resonance Frequency	$f_r$	81.632653		MHz	
2	Reference Temperature	$T_0$	+60	+70	°C	
3	Overtone Order	-	3			
4	Load Capacitance	$C_L$	$\infty$		pF	
5	Rated Drive Level	$P_0$	0.1		mW	
6	Frequency Adjustment Tolerance	$\frac{\Delta f}{f}$	-10	+10	$10^{-6}$	At $T_0$ °C
7	Resonance Resistance	$R_r$	-	40	$\Omega$	At $T_0$ °C
8	Frequency Variation with Temperature over $T_{op}$	$\frac{\Delta f}{f}$	Not applicable		$10^{-6}$	
9	Resistance Variation with Temperature over $T_{op}$	$\frac{\Delta R}{R}$	-20	+20	%	From resistance measured at $T_0$ °C
			-2.0	+2.0	$\Omega$	
10	Operating Temperature Range	$T_{op}$	-20	+80	°C	
11	Frequency variation with Drive Level	$\frac{\Delta f}{f}$	Not applicable		$10^{-6}$	
12	Resistance variation with Drive Level	$\frac{\Delta R}{R}$	Not applicable		%	
13	Motional Inductance	$L_1$	2.0	-	mH	
14	Motional Capacitance	$C_1$	Not applicable		fF	
15	Static Capacitance	$C_0$	0	5.0	pF	
16	Q Factor	Q	70 000	-	-	
17	Ratio of Unwanted: Response Resistance to Resonance Resistance or Response Impedance to Resonance Resistance	$R_p/R$ or $ Z_p /R$	2:1	-		In the frequency range: $f_r - 8163\text{kHz}$ to $f_r + 8163\text{kHz}$
18	Ageing	$\frac{\Delta f}{f}$	-3.0 -5.0	+3.0 +5.0	$10^{-6}$	After burn-in, first year. Over 10 years
19	Terminal Length	L	Figure 2		mm	

**TABLE 1(a) - TYPE VARIANT DETAILED INFORMATION**

TYPE VARIANT NO. 39

No.	Characteristics	Symbol	Limits		Unit	Remarks
			Min.	Max.		
1	Resonance Frequency	$f_L$	20		MHz	
2	Reference Temperature	$T_o$	+23	+27	°C	
3	Overtone Order	-	Fundamental			
4	Load Capacitance	$C_L$	32		pF	
5	Rated Drive Level	$P_o$	0.1		mW	
6	Frequency Adjustment Tolerance	$\frac{\Delta f}{f}$	-10	+10	$10^{-6}$	At $T_o$ °C
7	Resonance Resistance	$R_L$	-	30	$\Omega$	Over $T_{op}$
8	Frequency Variation with Temperature over $T_{op}$	$\frac{\Delta f}{f}$	-20	+20	$10^{-6}$	From frequency measured at $T_o$ °C
9	Resistance Variation with Temperature over $T_{op}$	$\frac{\Delta R}{R}$	-10 or -20	+10 or +20	%  $\Omega$	From resistance measured at $T_o$ °C
10	Operating Temperature Range	$T_{op}$	-30	+70	°C	
11	Frequency variation with Drive Level	$\frac{\Delta f}{f}$	Not applicable		$10^{-6}$	
12	Resistance variation with Drive Level	$\frac{\Delta R}{R}$	Not applicable		%	
13	Motional Inductance	$L_1$	Not applicable		mH	
14	Motional Capacitance	$C_1$	Not applicable		fF	
15	Static Capacitance	$C_o$	-	7.0	pF	
16	Q Factor	Q	80 000	-	-	
17	Ratio of Unwanted: Response Resistance to Resonance Resistance or Response Impedance to Resonance Resistance	$R_p/R$ or $ Z_p /R$	2:1	-		In the frequency range: $f_L$ -200kHz to $f_L$ +200kHz
18	Ageing	$\frac{\Delta f}{f}$	-2.0	+2.0	$10^{-6}$	Per year after Burn-in.
19	Terminal Length	L	Figure 2		mm	



**TABLE 1(a) - TYPE VARIANT DETAILED INFORMATION**

TYPE VARIANT NO. 40

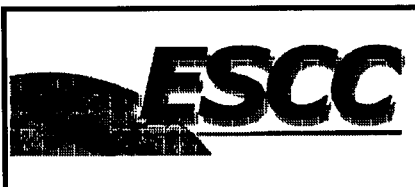
No.	Characteristics	Symbol	Limits		Unit	Remarks
			Min.	Max.		
1	Resonance Frequency	$f_r$	83.133333		MHz	
2	Reference Temperature	$T_0$	+60	+70	°C	
3	Overtone Order	-	3			
4	Load Capacitance	$C_L$	$\infty$		pF	
5	Rated Drive Level	$P_0$	0.1		mW	
6	Frequency Adjustment Tolerance	$\frac{\Delta f}{f}$	-10	+10	$10^{-6}$	At $T_0$ °C
7	Resonance Resistance	$R_r$	-	40	$\Omega$	At $T_0$ °C
8	Frequency Variation with Temperature over $T_{op}$	$\frac{\Delta f}{f}$	Not applicable		$10^{-6}$	
9	Resistance Variation with Temperature over $T_{op}$	$\frac{\Delta R}{R}$	-20	+20	%	From resistance measured at $T_0$ °C
10	Operating Temperature Range	$T_{op}$	-25	+80	°C	
11	Frequency variation with Drive Level	$\frac{\Delta f}{f}$	Not applicable		$10^{-6}$	
12	Resistance variation with Drive Level	$\frac{\Delta R}{R}$	Not applicable		%	
13	Motional Inductance	$L_1$	2.0	-	mH	
14	Motional Capacitance	$C_1$	Not applicable		fF	
15	Static Capacitance	$C_0$	-	5.0	pF	
16	Q Factor	Q	70 000	-	-	
17	Ratio of Unwanted: Response Resistance to Resonance Resistance or Response Impedance to Resonance Resistance	$R_p/R$ or $ Z_p /R$	2:1	-		In the frequency range: $f_r - 500\text{kHz}$ to $f_r + 500\text{kHz}$
18	Ageing	$\frac{\Delta f}{f}$	-5.0	+5.0	$10^{-6}$	13 years after Burn-in - Exterpolated
19	Terminal Length	L	Figure 2		mm	



**TABLE 1(a) - TYPE VARIANT DETAILED INFORMATION**

TYPE VARIANT NO. 41

No.	Characteristics	Symbol	Limits		Unit	Remarks
			Min.	Max.		
1	Resonance Frequency	$f_L$	16.0		MHz	
2	Reference Temperature	$T_o$	+23	+27	°C	
3	Overtone Order	-	Fundamental			
4	Load Capacitance	$C_L$	30		pF	
5	Rated Drive Level	$P_o$	0.1		mW	
6	Frequency Adjustment Tolerance	$\frac{\Delta f}{f}$	-10	+10	$10^{-6}$	At $T_o$ °C
7	Resonance Resistance	$R_L$	-	20	$\Omega$	Over $T_{op}$
8	Frequency Variation with Temperature over $T_{op}$	$\frac{\Delta f}{f}$	-30	+30	$10^{-6}$	From frequency measured at $T_o$ °C
9	Resistance Variation with Temperature over $T_{op}$	$\frac{\Delta R}{R}$	Not applicable		%	
10	Operating Temperature Range	$T_{op}$	-22	+90	°C	
11	Frequency variation with Drive Level	$\frac{\Delta f}{f}$	Not applicable		$10^{-6}$	
12	Resistance variation with Drive Level	$\frac{\Delta R}{R}$	Not applicable		%	
13	Motional Inductance	$L_1$	Not applicable		mH	
14	Motional Capacitance	$C_1$	Not applicable		fF	
15	Static Capacitance	$C_o$	Not applicable		pF	
16	Q Factor	Q	Not applicable		-	
17	Ratio of Unwanted: Response Resistance to Resonance Resistance or Response Impedance to Resonance Resistance	$R_p/R$ or $ Z_p /R$	Not applicable			
18	Ageing	$\frac{\Delta f}{f}$	-30	+30	$10^{-6}$	Per year after Burn-in
19	Terminal Length	L	Figure 2		mm	



**TABLE 1(a) - TYPE VARIANT DETAILED INFORMATION**

TYPE VARIANT NO. 42

No.	Characteristics	Symbol	Limits		Unit	Remarks
			Min.	Max.		
1	Resonance Frequency	$f_r$	20.0		MHz	
2	Reference Temperature	$T_0$	+23	+27	°C	
3	Overtone Order	-	Fundamental			
4	Load Capacitance	$C_L$	$\infty$		pF	
5	Rated Drive Level	$P_0$	0.1		mW	
6	Frequency Adjustment Tolerance	$\frac{\Delta f}{f}$	-10	+10	$10^{-6}$	At $T_0$ °C
7	Resonance Resistance	$R_r$	-	30	$\Omega$	At $T_0$ °C
8	Frequency Variation with Temperature over $T_{op}$	$\frac{\Delta f}{f}$	-100	+100	$10^{-6}$	From frequency measured at $T_0$ °C
9	Resistance Variation with Temperature over $T_{op}$	$\frac{\Delta R}{R}$	-20 or -2.0	+20 or +2.0	%  $\Omega$	From resistance measured at $T_0$ °C If $R \leq 10\Omega$
10	Operating Temperature Range	$T_{op}$	-30	+95	°C	
11	Frequency variation with Drive Level	$\frac{\Delta f}{f}$	Not applicable		$10^{-6}$	
12	Resistance variation with Drive Level	$\frac{\Delta R}{R}$	Not applicable		%	
13	Motional Inductance	$L_1$	Not applicable		mH	
14	Motional Capacitance	$C_1$	Not applicable		fF	
15	Static Capacitance	$C_0$	-	7.0	pF	
16	Q Factor	Q	100 000	-	-	
17	Ratio of Unwanted: Response Resistance to Resonance Resistance or Response Impedance to Resonance Resistance	$R_p/R$ or $ Z_p /R$	2:1	-		In the frequency range: $f_r - 200\text{kHz}$ to $f_r + 200\text{kHz}$
18	Ageing	$\frac{\Delta f}{f}$	-2.0	+2.0	$10^{-6}$	Per year after Burn-in
19	Terminal Length	L	Figure 2		mm	

**TABLE 1(a) - TYPE VARIANT DETAILED INFORMATION**

TYPE VARIANT NO. 43

No.	Characteristics	Symbol	Limits		Unit	Remarks
			Min.	Max.		
1	Resonance Frequency	$f_r$	83.312841		MHz	
2	Reference Temperature	$T_o$	+20	+30	°C	
3	Overtone Order	-	3			
4	Load Capacitance	$C_L$	$\infty$		pF	
5	Rated Drive Level	$P_o$	0.1		mW	
6	Frequency Adjustment Tolerance	$\frac{\Delta f}{f}$	-10	+10	$10^{-6}$	At $T_o$ °C
7	Resonance Resistance	$R_r$	-	50	$\Omega$	At $T_o$ °C
8	Frequency Variation with Temperature over $T_{op}$	$\frac{\Delta f}{f}$	0 -9.0 -9.0	+9.0 +9.0 0	$10^{-6}$	From T -25 to +10 °C From T +10 to +50 °C From T +50 to +70 °C
9	Resistance Variation with Temperature over $T_{op}$	$\frac{\Delta R}{R}$	-20	+20	%	From resistance measured at $T_o$ °C
10	Operating Temperature Range	$T_{op}$	-25	+70	°C	
11	Frequency variation with Drive Level	$\frac{\Delta f}{f}$	Not applicable		$10^{-6}$	
12	Resistance variation with Drive Level	$\frac{\Delta R}{R}$	Not applicable		%	
13	Motional Inductance	$L_1$	2.0	-	mH	
14	Motional Capacitance	$C_1$	Not applicable		fF	
15	Static Capacitance	$C_o$	-	5.0	pF	
16	Q Factor	Q	70 000	-	-	
17	Ratio of Unwanted: Response Resistance to Resonance Resistance or Response Impedance to Resonance Resistance	$R_p/R$ or $ Z_p /R$	2:1	-		In the frequency range: $f_r - 8331\text{kHz}$ to $f_r + 8331\text{kHz}$
18	Ageing	$\frac{\Delta f}{f}$	-3.0	+3.0	$10^{-6}$	10 years after Burn-in + Ageing of 720 hours
19	Terminal Length	L	Figure 2		mm	



**TABLE 1(a) - TYPE VARIANT DETAILED INFORMATION**

TYPE VARIANT NO. 44

No.	Characteristics	Symbol	Limits		Unit	Remarks
			Min.	Max.		
1	Resonance Frequency	$f_r$	83.316257		MHz	
2	Reference Temperature	$T_o$	+ 20	+ 30	°C	
3	Overtone Order	-	3			
4	Load Capacitance	$C_L$	$\infty$		pF	
5	Rated Drive Level	$P_o$	0.1		mW	
6	Frequency Adjustment Tolerance	$\frac{\Delta f}{f}$	- 10	+ 10	$10^{-6}$	At $T_o$ °C
7	Resonance Resistance	$R_r$	-	50	$\Omega$	At $T_o$ °C
8	Frequency Variation with Temperature over $T_{op}$	$\frac{\Delta f}{f}$	0 - 9.0 - 9.0	+ 9.0 + 9.0 0	$10^{-6}$	From T - 25 to + 10 °C From T + 10 to + 50 °C From T + 50 to + 70 °C
9	Resistance Variation with Temperature over $T_{op}$	$\frac{\Delta R}{R}$	- 20	+ 20	%	From resistance measured at $T_o$ °C
10	Operating Temperature Range	$T_{op}$	- 25	+ 70	°C	
11	Frequency variation with Drive Level	$\frac{\Delta f}{f}$	Not applicable		$10^{-6}$	
12	Resistance variation with Drive Level	$\frac{\Delta R}{R}$	Not applicable		%	
13	Motional Inductance	$L_1$	2.0	-	mH	
14	Motional Capacitance	$C_1$	Not applicable		fF	
15	Static Capacitance	$C_o$	-	5.0	pF	
16	Q Factor	Q	70 000	-	-	
17	Ratio of Unwanted: Response Resistance to Resonance Resistance or Response Impedance to Resonance Resistance	$R_p/R$ or $ Z_p /R$	2:1	-		In the frequency range: $f_r - 8331\text{kHz}$ to $f_r + 8331\text{kHz}$
18	Ageing	$\frac{\Delta f}{f}$	- 3.0	+ 3.0	$10^{-6}$	10 years after Burn-in + Ageing of 720 hours
19	Terminal Length	L	Figure 2		mm	

**TABLE 1(a) - TYPE VARIANT DETAILED INFORMATION**

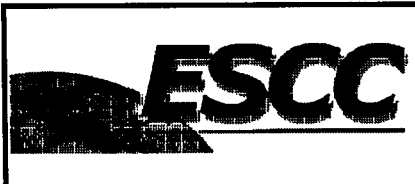
**TYPE VARIANT NO. 45**

No.	Characteristics	Symbol	Limits		Unit	Remarks
			Min.	Max.		
1	Resonance Frequency	$f_r$	83.319672		MHz	
2	Reference Temperature	$T_o$	+20	+30	°C	
3	Overtone Order	-	3			
4	Load Capacitance	$C_L$	$\infty$		pF	
5	Rated Drive Level	$P_o$	0.1		mW	
6	Frequency Adjustment Tolerance	$\frac{\Delta f}{f}$	-10	+10	$10^{-6}$	At $T_o$ °C
7	Resonance Resistance	$R_r$	-	50	$\Omega$	At $T_o$ °C
8	Frequency Variation with Temperature over $T_{op}$	$\frac{\Delta f}{f}$	0 -9.0 -9.0	+9.0 +9.0 0	$10^{-6}$	From T -25 to +10 °C From T +10 to +50 °C From T +50 to +70 °C
9	Resistance Variation with Temperature over $T_{op}$	$\frac{\Delta R}{R}$	-20	+20	%	From resistance measured at $T_o$ °C
10	Operating Temperature Range	$T_{op}$	-25	+70	°C	
11	Frequency variation with Drive Level	$\frac{\Delta f}{f}$	Not applicable		$10^{-6}$	
12	Resistance variation with Drive Level	$\frac{\Delta R}{R}$	Not applicable		%	
13	Motional Inductance	$L_1$	2.0	-	mH	
14	Motional Capacitance	$C_1$	Not applicable		fF	
15	Static Capacitance	$C_o$	-	5.0	pF	
16	Q Factor	Q	70 000	-	-	
17	Ratio of Unwanted: Response Resistance to Resonance Resistance or Response Impedance to Resonance Resistance	$R_p/R$ or $ Z_p /R$	2:1	-		In the frequency range: $f_r - 8331\text{kHz}$ to $f_r + 8331\text{kHz}$
18	Ageing	$\frac{\Delta f}{f}$	-3.0	+3.0	$10^{-6}$	10 years after Burn-in + Ageing of 720 hours
19	Terminal Length	L	Figure 2		mm	

**TABLE 1(a) - TYPE VARIANT DETAILED INFORMATION**

TYPE VARIANT NO. 46

No.	Characteristics	Symbol	Limits		Unit	Remarks
			Min.	Max.		
1	Resonance Frequency	$f_r$	83.326503		MHz	
2	Reference Temperature	$T_o$	+20	+30	°C	
3	Overtone Order	-	3			
4	Load Capacitance	$C_L$	$\infty$		pF	
5	Rated Drive Level	$P_o$	0.1		mW	
6	Frequency Adjustment Tolerance	$\frac{\Delta f}{f}$	-10	+10	$10^{-6}$	At $T_o$ °C
7	Resonance Resistance	$R_r$	-	50	$\Omega$	At $T_o$ °C
8	Frequency Variation with Temperature over $T_{op}$	$\frac{\Delta f}{f}$	0 -9.0 -9.0	+9.0 +9.0 0	$10^{-6}$	From T -25 to +10 °C From T +10 to +50 °C From T +50 to +70 °C
9	Resistance Variation with Temperature over $T_{op}$	$\frac{\Delta R}{R}$	-20	+20	%	From resistance measured at $T_o$ °C
10	Operating Temperature Range	$T_{op}$	-25	+70	°C	
11	Frequency variation with Drive Level	$\frac{\Delta f}{f}$	Not applicable		$10^{-6}$	
12	Resistance variation with Drive Level	$\frac{\Delta R}{R}$	Not applicable		%	
13	Motional Inductance	$L_1$	2.0	-	mH	
14	Motional Capacitance	$C_1$	Not applicable		fF	
15	Static Capacitance	$C_o$	-	5.0	pF	
16	Q Factor	Q	70 000	-	-	
17	Ratio of Unwanted: Response Resistance to Resonance Resistance or Response Impedance to Resonance Resistance	$R_p/R$ or $ Z_p /R$	2:1	-		In the frequency range: $f_r - 8332\text{kHz}$ to $f_r + 8332\text{kHz}$
18	Ageing	$\frac{\Delta f}{f}$	-3.0	+3.0	$10^{-6}$	10 years after Burn-in + Ageing of 720 hours
19	Terminal Length	L	Figure 2		mm	



**TABLE 1(a) - TYPE VARIANT DETAILED INFORMATION**

TYPE VARIANT NO. 47

No.	Characteristics	Symbol	Limits		Unit	Remarks
			Min.	Max.		
1	Resonance Frequency	$f_r$	83.340164		MHz	
2	Reference Temperature	$T_o$	+ 20	+ 30	°C	
3	Overtone Order	-	3			
4	Load Capacitance	$C_L$	$\infty$		pF	
5	Rated Drive Level	$P_o$	0.1		mW	
6	Frequency Adjustment Tolerance	$\frac{\Delta f}{f}$	- 10	+ 10	$10^{-6}$	At $T_o$ °C
7	Resonance Resistance	$R_r$	-	50	$\Omega$	At $T_o$ °C
8	Frequency Variation with Temperature over $T_{op}$	$\frac{\Delta f}{f}$	0 - 9.0 - 9.0	+ 9.0 + 9.0 0	$10^{-6}$	From T - 25 to + 10 °C From T + 10 to + 50 °C From T + 50 to + 70 °C
9	Resistance Variation with Temperature over $T_{op}$	$\frac{\Delta R}{R}$	- 20	+ 20	%	From resistance measured at $T_o$ °C
10	Operating Temperature Range	$T_{op}$	- 25	+ 70	°C	
11	Frequency variation with Drive Level	$\frac{\Delta f}{f}$	Not applicable		$10^{-6}$	
12	Resistance variation with Drive Level	$\frac{\Delta R}{R}$	Not applicable		%	
13	Motional Inductance	$L_1$	2.0	-	mH	
14	Motional Capacitance	$C_1$	Not applicable		fF	
15	Static Capacitance	$C_o$	-	5.0	pF	
16	Q Factor	Q	70 000	-	-	
17	Ratio of Unwanted: Response Resistance to Resonance Resistance or Response Impedance to Resonance Resistance	$R_p/R$ or $ Z_p /R$	2:1	-		In the frequency range: $f_r - 8334\text{kHz}$ to $f_r + 8334\text{kHz}$
18	Ageing	$\frac{\Delta f}{f}$	- 3.0	+ 3.0	$10^{-6}$	10 years after Burn-in + Ageing of 720 hours
19	Terminal Length	L	Figure 2		mm	



**TABLE 1(a) - TYPE VARIANT DETAILED INFORMATION**

TYPE VARIANT NO. 48

No.	Characteristics	Symbol	Limits		Unit	Remarks
			Min.	Max.		
1	Resonance Frequency	$f_r$	83.346994		MHz	
2	Reference Temperature	$T_o$	+ 20	+ 30	°C	
3	Overtone Order	-	3			
4	Load Capacitance	$C_L$	$\infty$		pF	
5	Rated Drive Level	$P_o$	0.1		mW	
6	Frequency Adjustment Tolerance	$\frac{\Delta f}{f}$	- 10	+ 10	$10^{-6}$	At $T_o$ °C
7	Resonance Resistance	$R_r$	-	50	$\Omega$	At $T_o$ °C
8	Frequency Variation with Temperature over $T_{op}$	$\frac{\Delta f}{f}$	0 - 9.0 - 9.0	+ 9.0 + 9.0 0	$10^{-6}$	From T - 25 to + 10 °C From T + 10 to + 50 °C From T + 50 to + 70 °C
9	Resistance Variation with Temperature over $T_{op}$	$\frac{\Delta R}{R}$	- 20	+ 20	%	From resistance measured at $T_o$ °C
10	Operating Temperature Range	$T_{op}$	- 25	+ 70	°C	
11	Frequency variation with Drive Level	$\frac{\Delta f}{f}$	Not applicable		$10^{-6}$	
12	Resistance variation with Drive Level	$\frac{\Delta R}{R}$	Not applicable		%	
13	Motional Inductance	$L_1$	2.0	-	mH	
14	Motional Capacitance	$C_1$	Not applicable		fF	
15	Static Capacitance	$C_o$	-	5.0	pF	
16	Q Factor	Q	70 000	-	-	
17	Ratio of Unwanted: Response Resistance to Resonance Resistance or Response Impedance to Resonance Resistance	$R_p/R$ or $ Z_p /R$	2:1	-		In the frequency range: $f_r - 8334\text{kHz}$ to $f_r + 8334\text{kHz}$
18	Ageing	$\frac{\Delta f}{f}$	- 3.0	+ 3.0	$10^{-6}$	10 years after Burn-in + Ageing of 720 hours
19	Terminal Length	L	Figure 2		mm	



**TABLE 1(a) - TYPE VARIANT DETAILED INFORMATION**

TYPE VARIANT NO. 49

No.	Characteristics	Symbol	Limits		Unit	Remarks
			Min.	Max.		
1	Resonance Frequency	$f_r$	83.353825		MHz	
2	Reference Temperature	$T_o$	+20	+30	°C	
3	Overtone Order	-	3			
4	Load Capacitance	$C_L$	$\infty$		pF	
5	Rated Drive Level	$P_o$	0.1		mW	
6	Frequency Adjustment Tolerance	$\frac{\Delta f}{f}$	-10	+10	$10^{-6}$	At $T_o$ °C
7	Resonance Resistance	$R_r$	-	50	$\Omega$	At $T_o$ °C
8	Frequency Variation with Temperature over $T_{op}$	$\frac{\Delta f}{f}$	0 -9.0 -9.0	+9.0 +9.0 0	$10^{-6}$	From T -25 to +10 °C From T +10 to +50 °C From T +50 to +70 °C
9	Resistance Variation with Temperature over $T_{op}$	$\frac{\Delta R}{R}$	-20	+20	%	From resistance measured at $T_o$ °C
10	Operating Temperature Range	$T_{op}$	-25	+70	°C	
11	Frequency variation with Drive Level	$\frac{\Delta f}{f}$	Not applicable		$10^{-6}$	
12	Resistance variation with Drive Level	$\frac{\Delta R}{R}$	Not applicable		%	
13	Motional Inductance	$L_1$	2.0	-	mH	
14	Motional Capacitance	$C_1$	Not applicable		fF	
15	Static Capacitance	$C_o$	-	5.0	pF	
16	Q Factor	Q	70 000	-	-	
17	Ratio of Unwanted: Response Resistance to Resonance Resistance or Response Impedance to Resonance Resistance	$R_p/R$ or $ Z_p /R$	2:1	-		In the frequency range: $f_r - 8335\text{kHz}$ to $f_r + 8335\text{kHz}$
18	Ageing	$\frac{\Delta f}{f}$	-3.0	+3.0	$10^{-6}$	10 years after Burn-in + Ageing of 720 hours
19	Terminal Length	L	Figure 2		mm	

**TABLE 1(a) - TYPE VARIANT DETAILED INFORMATION**

TYPE VARIANT NO. 50

No.	Characteristics	Symbol	Limits		Unit	Remarks
			Min.	Max.		
1	Resonance Frequency	$f_r$	83.360656		MHz	
2	Reference Temperature	$T_o$	+ 20	+ 30	°C	
3	Overtone Order	-	3			
4	Load Capacitance	$C_L$	$\infty$		pF	
5	Rated Drive Level	$P_o$	0.1		mW	
6	Frequency Adjustment Tolerance	$\frac{\Delta f}{f}$	- 10	+ 10	$10^{-6}$	At $T_o$ °C
7	Resonance Resistance	$R_r$	-	50	$\Omega$	At $T_o$ °C
8	Frequency Variation with Temperature over $T_{op}$	$\frac{\Delta f}{f}$	0 - 9.0 - 9.0	+ 9.0 + 9.0 0	$10^{-6}$	From T - 25 to + 10 °C From T + 10 to + 50 °C From T + 50 to + 70 °C
9	Resistance Variation with Temperature over $T_{op}$	$\frac{\Delta R}{R}$	- 20	+ 20	%	From resistance measured at $T_o$ °C
10	Operating Temperature Range	$T_{op}$	- 25	+ 70	°C	
11	Frequency variation with Drive Level	$\frac{\Delta f}{f}$	Not applicable		$10^{-6}$	
12	Resistance variation with Drive Level	$\frac{\Delta R}{R}$	Not applicable		%	
13	Motional Inductance	$L_1$	2.0	-	mH	
14	Motional Capacitance	$C_1$	Not applicable		fF	
15	Static Capacitance	$C_o$	-	5.0	pF	
16	Q Factor	Q	70 000	-	-	
17	Ratio of Unwanted: Response Resistance to Resonance Resistance or Response Impedance to Resonance Resistance	$R_p/R$ or $ Z_p /R$	2:1	-		In the frequency range: $f_r - 8336\text{kHz}$ to $f_r + 8336\text{kHz}$
18	Ageing	$\frac{\Delta f}{f}$	- 3.0	+ 3.0	$10^{-6}$	10 years after Burn-in + Ageing of 720 hours
19	Terminal Length	L	Figure 2		mm	



**TABLE 1(a) - TYPE VARIANT DETAILED INFORMATION**

TYPE VARIANT NO. 51

No.	Characteristics	Symbol	Limits		Unit	Remarks
			Min.	Max.		
1	Resonance Frequency	$f_r$	45.056		MHz	
2	Reference Temperature	$T_o$	+20	+30	°C	
3	Overtone Order	-	3			
4	Load Capacitance	$C_L$	$\infty$		pF	
5	Rated Drive Level	$P_o$	0.1		mW	
6	Frequency Adjustment Tolerance	$\frac{\Delta f}{f}$	-10	+10	$10^{-6}$	At $T_o$ °C
7	Resonance Resistance	$R_r$	-	23	$\Omega$	At $T_o$ °C
8	Frequency Variation with Temperature over $T_{op}$	$\frac{\Delta f}{f}$	0 -9.0 -9.0	+9.0 +9.0 0	$10^{-6}$	From T -25 to +10 °C From T +10 to +50 °C From T +50 to +70 °C
9	Resistance Variation with Temperature over $T_{op}$	$\frac{\Delta R}{R}$	-20	+20	%	From resistance measured at $T_o$ °C
10	Operating Temperature Range	$T_{op}$	-25	+70	°C	
11	Frequency variation with Drive Level	$\frac{\Delta f}{f}$	Not applicable		$10^{-6}$	
12	Resistance variation with Drive Level	$\frac{\Delta R}{R}$	Not applicable		%	
13	Motional Inductance	$L_1$	8.0	-	mH	
14	Motional Capacitance	$C_1$	Not applicable		fF	
15	Static Capacitance	$C_o$	-	7.0	pF	
16	Q Factor	Q	110 000	-	-	
17	Ratio of Unwanted: Response Resistance to Resonance Resistance or Response Impedance to Resonance Resistance	$R_p/R$ or $ Z_p /R$	2:1	-		In the frequency range: $f_r - 4500\text{kHz}$ to $f_r + 4500\text{kHz}$
18	Ageing	$\frac{\Delta f}{f}$	-5.0	+5.0	$10^{-6}$	10 years after Burn-in
19	Terminal Length	L	Figure 2		mm	

**TABLE 1(a) - TYPE VARIANT DETAILED INFORMATION**

TYPE VARIANT NO. 52

No.	Characteristics	Symbol	Limits		Unit	Remarks
			Min.	Max.		
1	Resonance Frequency	$f_r$	78.247951		MHz	
2	Reference Temperature	$T_o$	+20	+30	°C	
3	Overtone Order	-	3			
4	Load Capacitance	$C_L$	$\infty$		pF	
5	Rated Drive Level	$P_o$	0.1		mW	
6	Frequency Adjustment Tolerance	$\frac{\Delta f}{f}$	-10	+10	$10^{-6}$	At $T_o$ °C
7	Resonance Resistance	$R_r$	-	50	$\Omega$	At $T_o$ °C
8	Frequency Variation with Temperature over $T_{op}$	$\frac{\Delta f}{f}$	0 -9.0 -9.0	+9.0 +9.0 0	$10^{-6}$	From T -25 to +10 °C From T +10 to +50 °C From T +50 to +70 °C
9	Resistance Variation with Temperature over $T_{op}$	$\frac{\Delta R}{R}$	-20	+20	%	From resistance measured at $T_o$ °C
10	Operating Temperature Range	$T_{op}$	-25	+70	°C	
11	Frequency variation with Drive Level	$\frac{\Delta f}{f}$	Not applicable		$10^{-6}$	
12	Resistance variation with Drive Level	$\frac{\Delta R}{R}$	Not applicable		%	
13	Motional Inductance	$L_1$	6.5	-	mH	
14	Motional Capacitance	$C_1$	Not applicable		fF	
15	Static Capacitance	$C_o$	-	5.0	pF	
16	Q Factor	Q	70 000	-	-	
17	Ratio of Unwanted: Response Resistance to Resonance Resistance or Response Impedance to Resonance Resistance	$R_p/R$ or $ Z_p /R$	2:1	-		In the frequency range: $f_r - 7824\text{kHz}$ to $f_r + 7824\text{kHz}$
18	Ageing	$\frac{\Delta f}{f}$	-5.0	+5.0	$10^{-6}$	10 years after Burn-in
19	Terminal Length	L	Figure 2		mm	



**TABLE 1(a) - TYPE VARIANT DETAILED INFORMATION**

TYPE VARIANT NO. 53

No.	Characteristics	Symbol	Limits		Unit	Remarks
			Min.	Max.		
1	Resonance Frequency	$f_r$	78.213798		MHz	
2	Reference Temperature	$T_o$	+ 20	+ 30	°C	
3	Overtone Order	-	3			
4	Load Capacitance	$C_L$	$\infty$		pF	
5	Rated Drive Level	$P_o$	0.1		mW	
6	Frequency Adjustment Tolerance	$\frac{\Delta f}{f}$	- 10	+ 10	$10^{-6}$	At $T_o$ °C
7	Resonance Resistance	$R_r$	-	50	$\Omega$	At $T_o$ °C
8	Frequency Variation with Temperature over $T_{op}$	$\frac{\Delta f}{f}$	0 - 9.0 - 9.0	+ 9.0 + 9.0 0	$10^{-6}$	From T - 25 to + 10 °C From T + 10 to + 50 °C From T + 50 to + 70 °C
9	Resistance Variation with Temperature over $T_{op}$	$\frac{\Delta R}{R}$	- 20	+ 20	%	From resistance measured at $T_o$ °C
10	Operating Temperature Range	$T_{op}$	- 25	+ 70	°C	
11	Frequency variation with Drive Level	$\frac{\Delta f}{f}$	Not applicable		$10^{-6}$	
12	Resistance variation with Drive Level	$\frac{\Delta R}{R}$	Not applicable		%	
13	Motional Inductance	$L_1$	6.5	-	mH	
14	Motional Capacitance	$C_1$	Not applicable		fF	
15	Static Capacitance	$C_o$	-	5.0	pF	
16	Q Factor	Q	70 000	-	-	
17	Ratio of Unwanted: Response Resistance to Resonance Resistance or Response Impedance to Resonance Resistance	$R_p/R$ or $ Z_p /R$	2:1	-		In the frequency range: $f_r - 7821\text{kHz}$ to $f_r + 7821\text{kHz}$
18	Ageing	$\frac{\Delta f}{f}$	- 5.0	+ 5.0	$10^{-6}$	10 years after Burn-in
19	Terminal Length	L	Figure 2		mm	

**TABLE 1(a) - TYPE VARIANT DETAILED INFORMATION**

TYPE VARIANT NO. 54

No.	Characteristics	Symbol	Limits		Unit	Remarks
			Min.	Max.		
1	Resonance Frequency	$f_r$	78.227459		MHz	
2	Reference Temperature	$T_o$	+20	+30	°C	
3	Overtone Order	-	3			
4	Load Capacitance	$C_L$	$\infty$		pF	
5	Rated Drive Level	$P_o$	0.1		mW	
6	Frequency Adjustment Tolerance	$\frac{\Delta f}{f}$	-10	+10	$10^{-6}$	At $T_o$ °C
7	Resonance Resistance	$R_r$	-	50	$\Omega$	At $T_o$ °C
8	Frequency Variation with Temperature over $T_{op}$	$\frac{\Delta f}{f}$	0 -9.0 -9.0	+9.0 +9.0 0	$10^{-6}$	From T -25 to +10 °C From T +10 to +50 °C From T +50 to +70 °C
9	Resistance Variation with Temperature over $T_{op}$	$\frac{\Delta R}{R}$	-20	+20	%	From resistance measured at $T_o$ °C
10	Operating Temperature Range	$T_{op}$	-25	+70	°C	
11	Frequency variation with Drive Level	$\frac{\Delta f}{f}$	Not applicable		$10^{-6}$	
12	Resistance variation with Drive Level	$\frac{\Delta R}{R}$	Not applicable		%	
13	Motional Inductance	$L_1$	6.5	-	mH	
14	Motional Capacitance	$C_1$	Not applicable		fF	
15	Static Capacitance	$C_o$	-	5.0	pF	
16	Q Factor	Q	70 000	-	-	
17	Ratio of Unwanted: Response Resistance to Resonance Resistance or Response Impedance to Resonance Resistance	$R_p/R$ or $ Z_p /R$	2:1	-		In the frequency range: $f_r - 7822\text{kHz}$ to $f_r + 7822\text{kHz}$
18	Ageing	$\frac{\Delta f}{f}$	-5.0	+5.0	$10^{-6}$	10 years after Burn-in
19	Terminal Length	L	Figure 2		mm	

**TABLE 1(a) - TYPE VARIANT DETAILED INFORMATION**

TYPE VARIANT NO. 55

No.	Characteristics	Symbol	Limits		Unit	Remarks
			Min.	Max.		
1	Resonance Frequency	$f_r$	78.220628		MHz	
2	Reference Temperature	$T_o$	+20	+30	°C	
3	Overtone Order	-	3			
4	Load Capacitance	$C_L$	$\infty$		pF	
5	Rated Drive Level	$P_o$	0.1		mW	
6	Frequency Adjustment Tolerance	$\frac{\Delta f}{f}$	-10	+10	$10^{-6}$	At $T_o$ °C
7	Resonance Resistance	$R_r$	-	50	$\Omega$	At $T_o$ °C
8	Frequency Variation with Temperature over $T_{op}$	$\frac{\Delta f}{f}$	0 -9.0 -9.0	+9.0 +9.0 0	$10^{-6}$	From T -25 to +10 °C From T +10 to +50 °C From T +50 to +70 °C
9	Resistance Variation with Temperature over $T_{op}$	$\frac{\Delta R}{R}$	-20	+20	%	From resistance measured at $T_o$ °C
10	Operating Temperature Range	$T_{op}$	-25	+70	°C	
11	Frequency variation with Drive Level	$\frac{\Delta f}{f}$	Not applicable		$10^{-6}$	
12	Resistance variation with Drive Level	$\frac{\Delta R}{R}$	Not applicable		%	
13	Motional Inductance	$L_1$	6.5	-	mH	
14	Motional Capacitance	$C_1$	Not applicable		fF	
15	Static Capacitance	$C_o$	-	5.0	pF	
16	Q Factor	Q	70 000	-	-	
17	Ratio of Unwanted: Response Resistance to Resonance Resistance or Response Impedance to Resonance Resistance	$R_p/R$ or $ Z_p /R$	2:1	-		In the frequency range: $f_r - 7822\text{kHz}$ to $f_r + 7822\text{kHz}$
18	Ageing	$\frac{\Delta f}{f}$	-5.0	+5.0	$10^{-6}$	10 years after Burn-in
19	Terminal Length	L	Figure 2		mm	

**TABLE 1(a) - TYPE VARIANT DETAILED INFORMATION**

TYPE VARIANT NO. 56

No.	Characteristics	Symbol	Limits		Unit	Remarks
			Min.	Max.		
1	Resonance Frequency	$f_r$	81.666667		MHz	
2	Reference Temperature	$T_o$	+62	+72	°C	
3	Overtone Order	-	5			
4	Load Capacitance	$C_L$	$\infty$		pF	
5	Rated Drive Level	$P_o$	0.1		mW	
6	Frequency Adjustment Tolerance	$\frac{\Delta f}{f}$	-10	+10	$10^{-6}$	At $T_o$ °C
7	Resonance Resistance	$R_r$	-	45	$\Omega$	At $T_o$ °C
8	Frequency Variation with Temperature over $T_{op}$	$\frac{\Delta f}{f}$	Not applicable		$10^{-6}$	
9	Resistance Variation with Temperature over $T_{op}$	$\frac{\Delta R}{R}$	-20	+20	%	From resistance measured at $T_o$ °C
10	Operating Temperature Range	$T_{op}$	-20	+80	°C	
11	Frequency variation with Drive Level	$\frac{\Delta f}{f}$	Not applicable		$10^{-6}$	
12	Resistance variation with Drive Level	$\frac{\Delta R}{R}$	Not applicable		%	
13	Motional Inductance	$L_1$	8.0	-	mH	
14	Motional Capacitance	$C_1$	Not applicable		fF	
15	Static Capacitance	$C_o$	-	5.0	pF	
16	Q Factor	Q	70 000	-	-	
17	Ratio of Unwanted: Response Resistance to Resonance Resistance or Response Impedance to Resonance Resistance	$R_p/R$ or $ Z_p /R$	2:1	-		In the frequency range: $f_r - 8166\text{kHz}$ to $f_r + 8166\text{kHz}$
18	Ageing	$\frac{\Delta f}{f}$	-3.0	+3.0	$10^{-6}$	10 years after Burn-in + Ageing of 500 hours
19	Terminal Length	L	Figure 2		mm	





**TABLE 1(a) - TYPE VARIANT DETAILED INFORMATION**

TYPE VARIANT NO. 57

No.	Characteristics	Symbol	Limits		Unit	Remarks
			Min.	Max.		
1	Resonance Frequency	$f_r$	121.714286		MHz	
2	Reference Temperature	$T_o$	+23	+27	°C	
3	Overtone Order	-	5			
4	Load Capacitance	$C_L$	$\infty$		pF	
5	Rated Drive Level	$P_o$	0.1		mW	
6	Frequency Adjustment Tolerance	$\frac{\Delta f}{f}$	-10	+10	$10^{-6}$	At $T_o$ °C
7	Resonance Resistance	$R_r$	-	50	$\Omega$	At $T_o$ °C
8	Frequency Variation with Temperature over $T_{op}$	$\frac{\Delta f}{f}$	-8.0	+8.0	$10^{-6}$	From frequency measured at $T_o$ °C
9	Resistance Variation with Temperature over $T_{op}$	$\frac{\Delta R}{R}$	-20	+20	%	From resistance measured at $T_o$ °C
10	Operating Temperature Range	$T_{op}$	-20	+70	°C	
11	Frequency variation with Drive Level	$\frac{\Delta f}{f}$	Not applicable		$10^{-6}$	
12	Resistance variation with Drive Level	$\frac{\Delta R}{R}$	Not applicable		%	
13	Motional Inductance	$L_1$	Not applicable		mH	
14	Motional Capacitance	$C_1$	Not applicable		fF	
15	Static Capacitance	$C_o$	-	3.5	pF	
16	Q Factor	Q	50 000	-	-	
17	Ratio of Unwanted: Response Resistance to Resonance Resistance or Response Impedance to Resonance Resistance	$R_p/R$ or $ Z_p /R$	3:1	-		In the frequency range: $f_r - 500\text{kHz}$ to $f_r + 500\text{kHz}$
18	Ageing	$\frac{\Delta f}{f}$	-1.0	+1.0	$10^{-6}$	Over 5 years after Burn-in
19	Terminal Length	L	Figure 2		mm	

**TABLE 1(a) - TYPE VARIANT DETAILED INFORMATION**

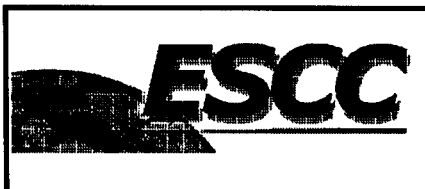
TYPE VARIANT NO. 58

No.	Characteristics	Symbol	Limits		Unit	Remarks
			Min.	Max.		
1	Resonance Frequency	$f_r$	116.471429		MHz	
2	Reference Temperature	$T_o$	+23	+27	°C	
3	Overtone Order	-	5			
4	Load Capacitance	$C_L$	$\infty$		pF	
5	Rated Drive Level	$P_o$	0.1		mW	
6	Frequency Adjustment Tolerance	$\frac{\Delta f}{f}$	-10	+10	$10^{-6}$	At $T_o$ °C
7	Resonance Resistance	$R_r$	-	50	$\Omega$	At $T_o$ °C
8	Frequency Variation with Temperature over $T_{op}$	$\frac{\Delta f}{f}$	-8.0	+8.0	$10^{-6}$	From frequency measured at $T_o$ °C
9	Resistance Variation with Temperature over $T_{op}$	$\frac{\Delta R}{R}$	-20	+20	%	From resistance measured at $T_o$ °C
10	Operating Temperature Range	$T_{op}$	-20	+70	°C	
11	Frequency variation with Drive Level	$\frac{\Delta f}{f}$	Not applicable		$10^{-6}$	
12	Resistance variation with Drive Level	$\frac{\Delta R}{R}$	Not applicable		%	
13	Motional Inductance	$L_1$	Not applicable		mH	
14	Motional Capacitance	$C_1$	Not applicable		fF	
15	Static Capacitance	$C_o$	-	3.5	pF	
16	Q Factor	Q	50 000	-	-	
17	Ratio of Unwanted: Response Resistance to Resonance Resistance or Response Impedance to Resonance Resistance	$R_p/R$ or $ Z_p /R$	3:1	-		In the frequency range: $f_r - 500\text{kHz}$ to $f_r + 500\text{kHz}$
18	Ageing	$\frac{\Delta f}{f}$	-1.0	+1.0	$10^{-6}$	Over 5 years after Burn-in
19	Terminal Length	L	Figure 2		mm	

**TABLE 1(a) - TYPE VARIANT DETAILED INFORMATION**

**TYPE VARIANT NO. 59**

No.	Characteristics	Symbol	Limits		Unit	Remarks
			Min.	Max.		
1	Resonance Frequency	$f_L$	4.194304		MHz	
2	Reference Temperature	$T_o$	+ 60		°C	
3	Overtone Order	-	Fundamental			
4	Load Capacitance	$C_L$	22		pF	
5	Rated Drive Level	$P_o$	0.1		mW	
6	Frequency Adjustment Tolerance	$\frac{\Delta f}{f}$	- 10	+ 10	$10^{-6}$	At $T_o$ °C
7	Resonance Resistance	$R_L$	-	75	$\Omega$	Over $T_{op}$
8	Frequency Variation with Temperature over $T_{op}$	$\frac{\Delta f}{f}$	- 15	+ 15	$10^{-6}$	From frequency measured at +25 °C
9	Resistance Variation with Temperature over $T_{op}$	$\frac{\Delta R}{R}$	Not applicable		%	
10	Operating Temperature Range	$T_{op}$	- 20	+ 70	°C	
11	Frequency variation with Drive Level	$\frac{\Delta f}{f}$	Not applicable		$10^{-6}$	
12	Resistance variation with Drive Level	$\frac{\Delta R}{R}$	Not applicable		%	
13	Motional Inductance	$L_1$	25	-	mH	
14	Motional Capacitance	$C_1$	Not applicable		fF	
15	Static Capacitance	$C_o$	-	5.0	pF	
16	Q Factor	Q	1 000 000	-	-	
17	Ratio of Unwanted: Response Resistance to Resonance Resistance or Response Impedance to Resonance Resistance	$R_p/R$ or $ Z_p /R$	3:1	-		In the frequency range: $f_L - 420\text{kHz}$ to $f_L + 420\text{kHz}$
18	Ageing	$\frac{\Delta f}{f}$	- 3.0	+ 3.0	$10^{-6}$	Per year after Burn-in
19	Terminal Length	L	Figure 2		mm	



**TABLE 1(a) - TYPE VARIANT DETAILED INFORMATION**

TYPE VARIANT NO. 60

No.	Characteristics	Symbol	Limits		Unit	Remarks
			Min.	Max.		
1	Resonance Frequency	$f_L$	16.0		MHz	
2	Reference Temperature	$T_0$	+23	+27	°C	
3	Overtone Order	-	Fundamental			
4	Load Capacitance	$C_L$	30		pF	
5	Rated Drive Level	$P_0$	0.1		mW	
6	Frequency Adjustment Tolerance	$\frac{\Delta f}{f}$	-10	+10	$10^{-6}$	At $T_0$ °C
7	Resonance Resistance	$R_L$	-	30	$\Omega$	At $T_0$ °C
8	Frequency Variation with Temperature over $T_{op}$	$\frac{\Delta f}{f}$	-15	+15	$10^{-6}$	From frequency measured at $T_0$ °C
9	Resistance Variation with Temperature over $T_{op}$	$\frac{\Delta R}{R}$	-20 or 1.0	+20 or 1.0	%  $\Omega$	From resistance measured at $T_0$ °C
10	Operating Temperature Range	$T_{op}$	-30	+70	°C	
11	Frequency variation with Drive Level	$\frac{\Delta f}{f}$	Not applicable		$10^{-6}$	
12	Resistance variation with Drive Level	$\frac{\Delta R}{R}$	Not applicable		%	
13	Motional Inductance	$L_1$	Not applicable		mH	
14	Motional Capacitance	$C_1$	Not applicable		fF	
15	Static Capacitance	$C_0$	-	7.0	pF	
16	Q Factor	Q	65 000	-	-	
17	Ratio of Unwanted: Response Resistance to Resonance Resistance or Response Impedance to Resonance Resistance	$R_p/R$ or $ Z_p /R$	2:1	-		In the frequency range: $f_L - 200\text{kHz}$ to $f_L + 200\text{kHz}$
18	Ageing	$\frac{\Delta f}{f}$	-1.0	+1.0	$10^{-6}$	Per year after Burn-in
19	Terminal Length	L	Figure 2		mm	



**TABLE 1(a) - TYPE VARIANT DETAILED INFORMATION**

TYPE VARIANT NO. 61

No.	Characteristics	Symbol	Limits		Unit	Remarks
			Min.	Max.		
1	Resonance Frequency	$f_L$	10.0		MHz	
2	Reference Temperature	$T_0$	+27	+33	°C	
3	Overtone Order	-	Fundamental			
4	Load Capacitance	$C_L$	25	35	pF	
5	Rated Drive Level	$P_0$	0.1		mW	
6	Frequency Adjustment Tolerance	$\frac{\Delta f}{f}$	-10	+10	$10^{-6}$	At $T_0$ °C
7	Resonance Resistance	$R_L$	-	30	$\Omega$	At $T_0$ °C
8	Frequency Variation with Temperature over $T_{op}$	$\frac{\Delta f}{f}$	-15	+15	$10^{-6}$	From frequency measured at $T_0$ °C
9	Resistance Variation with Temperature over $T_{op}$	$\frac{\Delta R}{R}$	Not applicable		%	
10	Operating Temperature Range	$T_{op}$	-30	+70	°C	
11	Frequency variation with Drive Level	$\frac{\Delta f}{f}$	Not applicable		$10^{-6}$	
12	Resistance variation with Drive Level	$\frac{\Delta R}{R}$	Not applicable		%	
13	Motional Inductance	$L_1$	Not applicable		mH	
14	Motional Capacitance	$C_1$	Not applicable		fF	
15	Static Capacitance	$C_0$	-	7.0	pF	
16	Q Factor	Q	Not applicable		-	
17	Ratio of Unwanted: Response Resistance to Resonance Resistance or Response Impedance to Resonance Resistance	$R_p/R$ or $ Z_p /R$	Not applicable			
18	Ageing	$\frac{\Delta f}{f}$	-1.0	+1.0	$10^{-6}$	Per year after Burn-in
19	Terminal Length	L	Figure 2		mm	

**TABLE 1(a) - TYPE VARIANT DETAILED INFORMATION**

TYPE VARIANT NO. 62

No.	Characteristics	Symbol	Limits		Unit	Remarks
			Min.	Max.		
1	Resonance Frequency	$f_L$	25.0		MHz	
2	Reference Temperature	$T_o$	+23	+27	°C	
3	Overtone Order	-	Fundamental			
4	Load Capacitance	$C_L$	30		pF	
5	Rated Drive Level	$P_o$	0.1		mW	
6	Frequency Adjustment Tolerance	$\frac{\Delta f}{f}$	-10	+10	$10^{-6}$	At $T_o$ °C
7	Resonance Resistance	$R_L$	-	10	$\Omega$	At $T_o$ °C
8	Frequency Variation with Temperature over $T_{op}$	$\frac{\Delta f}{f}$	-10	+10	$10^{-6}$	From frequency measured at $T_o$ °C
9	Resistance Variation with Temperature over $T_{op}$	$\frac{\Delta R}{R}$	Not applicable		%	
10	Operating Temperature Range	$T_{op}$	-30	+80	°C	
11	Frequency variation with Drive Level	$\frac{\Delta f}{f}$	Not applicable		$10^{-6}$	
12	Resistance variation with Drive Level	$\frac{\Delta R}{R}$	Not applicable		%	
13	Motional Inductance	$L_1$	2.7	-	mH	
14	Motional Capacitance	$C_1$	Not applicable		fF	
15	Static Capacitance	$C_o$	-	5.0	pF	
16	Q Factor	Q	40 000	-	-	
17	Ratio of Unwanted: Response Resistance to Resonance Resistance or Response Impedance to Resonance Resistance	$R_p/R$ or $ Z_p /R$	4:1	-		In the frequency range: $f_L - 50\text{kHz}$ to $f_L + 50\text{kHz}$
			5:1	-		Overtones 3 and 5
18	Ageing	$\frac{\Delta f}{f}$	-2.0	+2.0	$10^{-6}$	1 year after Burn-in at $T_o$
19	Terminal Length	L	Figure 2		mm	
20	Intended Application		X0			

**TABLE 1(a) - TYPE VARIANT DETAILED INFORMATION**

**TYPE VARIANT NO. 63**

No.	Characteristics	Symbol	Limits		Unit	Remarks
			Min.	Max.		
1	Resonance Frequency	$f_L$	90.0		MHz	
2	Reference Temperature	$T_o$	+23	+27	°C	
3	Overtone Order	-	3			
4	Load Capacitance	$C_L$	11.9	12.1	pF	
5	Rated Drive Level	$P_o$	0.1		mW	
6	Frequency Adjustment Tolerance	$\frac{\Delta f}{f}$	-5.0	+5.0	$10^{-6}$	At $T_o$ °C
7	Resonance Resistance	$R_L$	-	20	$\Omega$	At $T_o$ °C
8	Frequency Variation with Temperature over $T_{op}$	$\frac{\Delta f}{f}$	-5.0	+5.0	$10^{-6}$	At $T_{op} = -20$ to $+70$ °C
			-10	+10		At $T_{op} = -20$ to $+85$ °C
9	Resistance Variation with Temperature over $T_{op}$	$\frac{\Delta R}{R}$	Not applicable		%	
10	Operating Temperature Range	$T_{op}$	-20	+85	°C	
11	Frequency variation with Drive Level	$\frac{\Delta f}{f}$	Not applicable		$10^{-6}$	
12	Resistance variation with Drive Level	$\frac{\Delta R}{R}$	Not applicable		%	
13	Motional Inductance	$L_1$	-	-	mH	
14	Motional Capacitance	$C_1$	1.7	-	fF	
15	Static Capacitance	$C_o$	-	5.0	pF	
16	Q Factor	Q	50 000	-	-	
17	Ratio of Unwanted: Response Resistance to Resonance Resistance or Response Impedance to Resonance Resistance	$R_p/R$ or $ Z_p /R$	3.16:1	-		In the frequency range: $f_L - 100$ kHz to $f_L + 100$ kHz
18	Ageing	$\frac{\Delta f}{f}$	-6.0	+6.0	$10^{-6}$	Over 20 years at rated drive level
19	Terminal Length	L	Figure 2		mm	
20	Intended Application		-			



**TABLE 1(a) - TYPE VARIANT DETAILED INFORMATION**

TYPE VARIANT NO. 64

No.	Characteristics	Symbol	Limits		Unit	Remarks
			Min.	Max.		
1	Resonance Frequency	$f_r$	83.366142		MHz	
2	Reference Temperature	$T_o$	+ 62	+ 72	°C	
3	Overtone Order	-	3			
4	Load Capacitance	$C_L$	$\infty$		pF	
5	Rated Drive Level	$P_o$	0.1		mW	
6	Frequency Adjustment Tolerance	$\frac{\Delta f}{f}$	- 10	+ 10	$10^{-6}$	At $T_o$ °C
7	Resonance Resistance	$R_r$	-	40	$\Omega$	At $T_o$ °C
8	Frequency Variation with Temperature over $T_{op}$	$\frac{\Delta f}{f}$	Not applicable		$10^{-6}$	
9	Resistance Variation with Temperature over $T_{op}$	$\frac{\Delta R}{R}$	- 20	+ 20	%	From resistance measured at $T_o$ °C
10	Operating Temperature Range	$T_{op}$	- 20	+ 80	°C	
11	Frequency variation with Drive Level	$\frac{\Delta f}{f}$	Not applicable		$10^{-6}$	
12	Resistance variation with Drive Level	$\frac{\Delta R}{R}$	Not applicable		%	
13	Motional Inductance	$L_1$	2.0	-	mH	
14	Motional Capacitance	$C_1$	Not applicable		fF	
15	Static Capacitance	$C_o$	-	5.0	pF	
16	Q Factor	Q	70 000	-	-	
17	Ratio of Unwanted: Response Resistance to Resonance Resistance or Response Impedance to Resonance Resistance	$R_p/R$ or $ Z_p /R$	2:1	-		In the frequency range: $f_r - 10\%$ to $f_r + 10\%$
18	Ageing	$\frac{\Delta f}{f}$	- 3.0	+ 3.0	$10^{-6}$	10 years after Burn-in + Ageing of 500 hours
19	Terminal Length	L	Figure 2		mm	
20	Intended Application		-			



**TABLE 1(a) - TYPE VARIANT DETAILED INFORMATION**

**TYPE VARIANT NO. 65**

No.	Characteristics	Symbol	Limits		Unit	Remarks
			Min.	Max.		
1	Resonance Frequency	$f_r$	70.975328		MHz	
2	Reference Temperature	$T_0$	+20	+30	°C	
3	Overtone Order	-	3			
4	Load Capacitance	$C_L$	$\infty$		pF	
5	Rated Drive Level	$P_0$	0.2		mW	
6	Frequency Adjustment Tolerance	$\frac{\Delta f}{f}$	-10	+10	$10^{-6}$	At $T_0$ °C
7	Resonance Resistance	$R_r$	-	40	$\Omega$	At $T_0$ °C
8	Frequency Variation with Temperature over $T_{op}$	$\frac{\Delta f}{f}$	0 -9.0 -9.0	+9.0 +9.0 0	$10^{-6}$	From T -25 to +10 °C From T +10 to +50 °C From T +50 to +70 °C
9	Resistance Variation with Temperature over $T_{op}$	$\frac{\Delta R}{R}$	-20	+20	%	From resistance measured at $T_0$ °C
10	Operating Temperature Range	$T_{op}$	-25	+70	°C	
11	Frequency variation with Drive Level	$\frac{\Delta f}{f}$	Not applicable		$10^{-6}$	
12	Resistance variation with Drive Level	$\frac{\Delta R}{R}$	Not applicable		%	
13	Motional Inductance	$L_1$	6.5	-	mH	
14	Motional Capacitance	$C_1$	Not applicable		fF	
15	Static Capacitance	$C_0$	-	5.0	pF	
16	Q Factor	Q	80 000	-	-	
17	Ratio of Unwanted: Response Resistance to Resonance Resistance or Response Impedance to Resonance Resistance	$R_p/R$ or $ Z_p /R$	2:1	-		In the frequency range: $f_r - 7100\text{kHz}$ to $f_r + 7100\text{kHz}$
18	Ageing	$\frac{\Delta f}{f}$	-3.0	+3.0	$10^{-6}$	12 years after Burn-in + Ageing of 500 hours
19	Terminal Length	L	Figure 2		mm	
20	Intended Application		-			



**TABLE 1(a) - TYPE VARIANT DETAILED INFORMATION**

TYPE VARIANT NO. 66

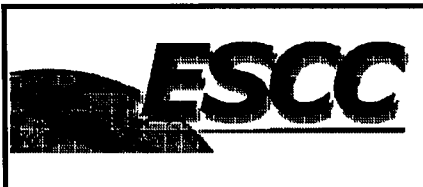
No.	Characteristics	Symbol	Limits		Unit	Remarks
			Min.	Max.		
1	Resonance Frequency	$f_r$	79.93306		MHz	
2	Reference Temperature	$T_o$	+ 60	+ 70	°C	
3	Overtone Order	-	3			
4	Load Capacitance	$C_L$	$\infty$		pF	
5	Rated Drive Level	$P_o$	0.1		mW	
6	Frequency Adjustment Tolerance	$\frac{\Delta f}{f}$	- 10	+ 10	$10^{-6}$	At $T_o$ °C
7	Resonance Resistance	$R_r$	-	40	$\Omega$	At $T_o$ °C
8	Frequency Variation with Temperature over $T_{op}$	$\frac{\Delta f}{f}$	Not applicable		$10^{-6}$	
9	Resistance Variation with Temperature over $T_{op}$	$\frac{\Delta R}{R}$	- 20	+ 20	%	From resistance measured at $T_o$ °C
10	Operating Temperature Range	$T_{op}$	- 20	+ 80	°C	
11	Frequency variation with Drive Level	$\frac{\Delta f}{f}$	Not applicable		$10^{-6}$	
12	Resistance variation with Drive Level	$\frac{\Delta R}{R}$	Not applicable		%	
13	Motional Inductance	$L_1$	2.0	-	mH	
14	Motional Capacitance	$C_1$	Not applicable		fF	
15	Static Capacitance	$C_o$	-	5.0	pF	
16	Q Factor	Q	70 000	-	-	
17	Ratio of Unwanted: Response Resistance to Resonance Resistance or Response Impedance to Resonance Resistance	$R_p/R$ or $ Z_p /R$	2:1	-		In the frequency range: $f_r - 8000\text{kHz}$ to $f_r + 8000\text{kHz}$
18	Ageing	$\frac{\Delta f}{f}$	- 3.0	+ 3.0	$10^{-6}$	12 years after Burn-in + Ageing of 500 hours
19	Terminal Length	L	Figure 2		mm	
20	Intended Application		-			



**TABLE 1(a) - TYPE VARIANT DETAILED INFORMATION**

TYPE VARIANT NO. 67

No.	Characteristics	Symbol	Limits		Unit	Remarks
			Min.	Max.		
1	Resonance Frequency	$f_r$	79.941257		MHz	
2	Reference Temperature	$T_o$	+ 60	+ 70	°C	
3	Overtone Order	-	3			
4	Load Capacitance	$C_L$	$\infty$		pF	
5	Rated Drive Level	$P_o$	0.1		mW	
6	Frequency Adjustment Tolerance	$\frac{\Delta f}{f}$	- 10	+ 10	$10^{-6}$	At $T_o$ °C
7	Resonance Resistance	$R_r$	-	40	$\Omega$	At $T_o$ °C
8	Frequency Variation with Temperature over $T_{op}$	$\frac{\Delta f}{f}$	Not applicable		$10^{-6}$	
9	Resistance Variation with Temperature over $T_{op}$	$\frac{\Delta R}{R}$	- 20	+ 20	%	From resistance measured at $T_o$ °C
10	Operating Temperature Range	$T_{op}$	- 20	+ 80	°C	
11	Frequency variation with Drive Level	$\frac{\Delta f}{f}$	Not applicable		$10^{-6}$	
12	Resistance variation with Drive Level	$\frac{\Delta R}{R}$	Not applicable		%	
13	Motional Inductance	$L_1$	2.0	-	mH	
14	Motional Capacitance	$C_1$	Not applicable		fF	
15	Static Capacitance	$C_o$	-	5.0	pF	
16	Q Factor	Q	70 000	-	-	
17	Ratio of Unwanted: Response Resistance to Resonance Resistance or Response Impedance to Resonance Resistance	$R_p/R$ or $ Z_p /R$	2:1	-		In the frequency range: $f_r - 8000\text{kHz}$ to $f_r + 8000\text{kHz}$
18	Ageing	$\frac{\Delta f}{f}$	- 3.0	+ 3.0	$10^{-6}$	12 years after Burn-in + Ageing of 500 hours
19	Terminal Length	L	Figure 2		mm	
20	Intended Application		-			



**TABLE 1(a) - TYPE VARIANT DETAILED INFORMATION**

**TYPE VARIANT NO. 68**

No.	Characteristics	Symbol	Limits		Unit	Remarks
			Min.	Max.		
1	Resonance Frequency	$f_L$	9.2		MHz	
2	Reference Temperature	$T_0$	+ 27	+ 33	°C	
3	Overtone Order	-	Fundamental			
4	Load Capacitance	$C_L$	25	35	pF	
5	Rated Drive Level	$P_0$	0.1		mW	
6	Frequency Adjustment Tolerance	$\frac{\Delta f}{f}$	- 10	+ 10	$10^{-6}$	At $T_0$ °C
7	Resonance Resistance	$R_L$	-	30	$\Omega$	At $T_0$ °C
8	Frequency Variation with Temperature over $T_{op}$	$\frac{\Delta f}{f}$	- 15	+ 15	$10^{-6}$	From frequency measured at $T_0$ °C
9	Resistance Variation with Temperature over $T_{op}$	$\frac{\Delta R}{R}$	- 20 or - 2.0	+ 20 or + 2.0	%  $\Omega$	From resistance measured at $T_0$ °C
10	Operating Temperature Range	$T_{op}$	- 30	+ 70	°C	
11	Frequency variation with Drive Level	$\frac{\Delta f}{f}$	Not applicable		$10^{-6}$	
12	Resistance variation with Drive Level	$\frac{\Delta R}{R}$	Not applicable		%	
13	Motional Inductance	$L_1$	Not applicable		mH	
14	Motional Capacitance	$C_1$	Not applicable		fF	
15	Static Capacitance	$C_0$	-	7.0	pF	
16	Q Factor	Q	Not applicable		-	
17	Ratio of Unwanted: Response Resistance to Resonance Resistance or Response Impedance to Resonance Resistance	$R_p/R$ or $ Z_p /R$	Not applicable			
18	Ageing	$\frac{\Delta f}{f}$	- 1.0	+ 1.0	$10^{-6}$	Per year after Burn-in
19	Terminal Length	L	Figure 2		mm	
20	Intended Application		X0			



**TABLE 1(a) - TYPE VARIANT DETAILED INFORMATION**

TYPE VARIANT NO. 69

No.	Characteristics	Symbol	Limits		Unit	Remarks
			Min.	Max.		
1	Resonance Frequency	$f_L$	24.0		MHz	
2	Reference Temperature	$T_o$	+ 25	+ 29	°C	
3	Overtone Order	-	Fundamental			
4	Load Capacitance	$C_L$	30		pF	
5	Rated Drive Level	$P_o$	0.1		mW	
6	Frequency Adjustment Tolerance	$\frac{\Delta f}{f}$	- 10	+ 10	$10^{-6}$	At $T_o$ °C
7	Resonance Resistance	$R_L$	-	120	$\Omega$	At $T_o$ °C
8	Frequency Variation with Temperature over $T_{op}$	$\frac{\Delta f}{f}$	- 40	+ 40	$10^{-6}$	From frequency measured at $T_o$ °C
9	Resistance Variation with Temperature over $T_{op}$	$\frac{\Delta R}{R}$	+ 20 or - 2.0	+ 20 or + 2.0	%  $\Omega$	From resistance measured at $T_o$ °C If $R \leq 10\Omega$
10	Operating Temperature Range	$T_{op}$	- 55	+ 100	°C	
11	Frequency variation with Drive Level	$\frac{\Delta f}{f}$	Not applicable		$10^{-6}$	
12	Resistance variation with Drive Level	$\frac{\Delta R}{R}$	Not applicable		%	
13	Motional Inductance	$L_1$	Not applicable		mH	
14	Motional Capacitance	$C_1$	Not applicable		fF	
15	Static Capacitance	$C_o$	-	7.0	pF	
16	Q Factor	Q	60 000	-	-	
17	Ratio of Unwanted: Response Resistance to Resonance Resistance or Response Impedance to Resonance Resistance	$R_p/R$ or $ Z_p /R$	2:1	-		In the frequency range: $f_L - 200\text{kHz}$ to $f_L + 200\text{kHz}$
18	Ageing	$\frac{\Delta f}{f}$	- 3.0	+ 3.0	$10^{-6}$	Per year after Burn-in
19	Terminal Length	L	Figure 2		mm	
20	Intended Application		-			

**TABLE 1(a) - TYPE VARIANT DETAILED INFORMATION**

TYPE VARIANT NO. 70

No.	Characteristics	Symbol	Limits		Unit	Remarks
			Min.	Max.		
1	Resonance Frequency	$f_r$	76.8315		MHz	
2	Reference Temperature	$T_0$	+ 23	+ 27	°C	
3	Overtone Order	-	3			
4	Load Capacitance	$C_L$	$\infty$		pF	
5	Rated Drive Level	$P_0$	0.2		mW	
6	Frequency Adjustment Tolerance	$\frac{\Delta f}{f}$	- 10	+ 10	$10^{-6}$	At $T_0$ °C
7	Resonance Resistance	$R_r$	-	50	$\Omega$	At $T_0$ °C
8	Frequency Variation with Temperature over $T_{op}$	$\frac{\Delta f}{f}$	- 10	+ 10	$10^{-6}$	From frequency measured at $T_0$ °C
9	Resistance Variation with Temperature over $T_{op}$	$\frac{\Delta R}{R}$	+ 20	+ 20	%	From resistance measured at $T_0$ °C
10	Operating Temperature Range	$T_{op}$	- 25	+ 80	°C	
11	Frequency variation with Drive Level	$\frac{\Delta f}{f}$	Not applicable		$10^{-6}$	
12	Resistance variation with Drive Level	$\frac{\Delta R}{R}$	Not applicable		%	
13	Motional Inductance	$L_1$	Not applicable		mH	
14	Motional Capacitance	$C_1$	Not applicable		fF	
15	Static Capacitance	$C_0$	-	3.5	pF	
16	Q Factor	Q	50 000	-	-	
17	Ratio of Unwanted: Response Resistance to Resonance Resistance or Response Impedance to Resonance Resistance	$R_p/R$ or $ Z_p /R$	3:1	-		In the frequency range: $f_r - 5000\text{kHz}$ to $f_r + 5000\text{kHz}$
18	Ageing	$\frac{\Delta f}{f}$	- 2.0	+ 2.0	$10^{-6}$	Over 5 years after Burn-in
19	Terminal Length	L	Figure 2		mm	
20	Intended Application		-			



**TABLE 1(a) - TYPE VARIANT DETAILED INFORMATION**

TYPE VARIANT NO. 71

No.	Characteristics	Symbol	Limits		Unit	Remarks
			Min.	Max.		
1	Resonance Frequency	$f_L$	20.0		MHz	
2	Reference Temperature	$T_o$	+ 24	+ 26	°C	
3	Overtone Order	-	Fundamental			
4	Load Capacitance	$C_L$	30		pF	
5	Rated Drive Level	$P_o$	0.1		mW	
6	Frequency Adjustment Tolerance	$\frac{\Delta f}{f}$	- 20	+ 20	$10^{-6}$	At $T_o$ °C
7	Resonance Resistance	$R_L$	-	20	$\Omega$	At $T_o$ °C
8	Frequency Variation with Temperature over $T_{op}$	$\frac{\Delta f}{f}$	- 50	+ 50	$10^{-6}$	From frequency measured at $T_o$ °C
9	Resistance Variation with Temperature over $T_{op}$	$\frac{\Delta R}{R}$	Not applicable		%	
10	Operating Temperature Range	$T_{op}$	- 30	+ 80	°C	
11	Frequency variation with Drive Level	$\frac{\Delta f}{f}$	Not applicable		$10^{-6}$	
12	Resistance variation with Drive Level	$\frac{\Delta R}{R}$	Not applicable		%	
13	Motional Inductance	$L_1$	Not applicable		mH	
14	Motional Capacitance	$C_1$	Not applicable		fF	
15	Static Capacitance	$C_o$	-	4.5	pF	
16	Q Factor	Q	50 000	-	-	
17	Ratio of Unwanted: Response Resistance to Resonance Resistance or Response Impedance to Resonance Resistance	$R_p/R$ or $ Z_p /R$	3:1	-		In the frequency range: $f_L - 200\text{kHz}$ to $f_L + 200\text{kHz}$
18	Ageing	$\frac{\Delta f}{f}$	- 3.0	+ 3.0	$10^{-6}$	Per year after Burn-in
19	Terminal Length	L	Figure 2		mm	
20	Intended Application		-			



**TABLE 1(a) - TYPE VARIANT DETAILED INFORMATION**

**TYPE VARIANT NO. 72**

No.	Characteristics	Symbol	Limits		Unit	Remarks
			Min.	Max.		
1	Resonance Frequency	$f_L$	20.0		MHz	
2	Reference Temperature	$T_o$	+ 23	+ 27	°C	
3	Overtone Order	-	Fundamental			
4	Load Capacitance	$C_L$	29.7	30.3	pF	
5	Rated Drive Level	$P_o$	0.2		mW	
6	Frequency Adjustment Tolerance	$\frac{\Delta f}{f}$	- 50	+ 50	$10^{-6}$	At $T_o$ °C
7	Resonance Resistance	$R_L$	-	20	$\Omega$	At $T_o$ °C
8	Frequency Variation with Temperature over $T_{op}$	$\frac{\Delta f}{f}$	- 50	+ 50	$10^{-6}$	From frequency measured at $T_o$ °C
9	Resistance Variation with Temperature over $T_{op}$	$\frac{\Delta R}{R}$	Not applicable		%	
10	Operating Temperature Range	$T_{op}$	- 55	+ 105	°C	
11	Frequency variation with Drive Level	$\frac{\Delta f}{f}$	Not applicable		$10^{-6}$	
12	Resistance variation with Drive Level	$\frac{\Delta R}{R}$	Not applicable		%	
13	Motional Inductance	$L_1$	Not applicable		mH	
14	Motional Capacitance	$C_1$	Not applicable		fF	
15	Static Capacitance	$C_o$	-	7.0	pF	
16	Q Factor	Q	50 000	-	-	
17	Ratio of Unwanted: Response Resistance to Resonance Resistance or Response Impedance to Resonance Resistance	$R_p/R$ or $ Z_p /R$	7:1	-		In the frequency range: $f_L - 500\text{kHz}$ to $f_L + 500\text{kHz}$
18	Ageing	$\frac{\Delta f}{f}$	- 15	+ 15	$10^{-6}$	After Burn-in over 5 years
19	Terminal Length	L	Figure 2		mm	
20	Intended Application		-			





**TABLE 1(a) - TYPE VARIANT DETAILED INFORMATION**

TYPE VARIANT NO. 73

No.	Characteristics	Symbol	Limits		Unit	Remarks
			Min.	Max.		
1	Resonance Frequency	$f_r$	40.960		MHz	
2	Reference Temperature	$T_o$	+ 20	+ 30	°C	
3	Overtone Order	-	3			
4	Load Capacitance	$C_L$	$\infty$		pF	
5	Rated Drive Level	$P_o$	0.1		mW	
6	Frequency Adjustment Tolerance	$\frac{\Delta f}{f}$	- 10	+ 10	$10^{-6}$	At $T_o$ °C
7	Resonance Resistance	$R_r$	-	40	$\Omega$	At $T_o$ °C
8	Frequency Variation with Temperature over $T_{op}$	$\frac{\Delta f}{f}$	0 - 9.0 - 9.0	+ 9.0 + 9.0 0	$10^{-6}$	From T - 25 to + 10 °C From T + 10 to + 50 °C From T + 50 to + 70 °C
9	Resistance Variation with Temperature over $T_{op}$	$\frac{\Delta R}{R}$	- 20	+ 20	%	From resistance measured at $T_o$ °C
10	Operating Temperature Range	$T_{op}$	- 25	+ 70	°C	
11	Frequency variation with Drive Level	$\frac{\Delta f}{f}$	- 0.5	+ 0.5	$10^{-6}$	From $P_{S1} = 0.01mW$ to $P_{S2} = 0.1mW$
12	Resistance variation with Drive Level	$\frac{\Delta R}{R}$	- 20	+ 20	%	From $P_{S1} = 0.01mW$ to $P_{S2} = 0.1mW$
13	Motional Inductance	$L_1$	5.0	-	mH	
14	Motional Capacitance	$C_1$	Not applicable		fF	
15	Static Capacitance	$C_o$	-	5.0	pF	
16	Q Factor	Q	70 000	-	-	
17	Ratio of Unwanted: Response Resistance to Resonance Resistance or Response Impedance to Resonance Resistance	$R_p/R$ or $iZ_p/I/R$	4:1	-		In the frequency range: $f_r - 4000kHz$ to $f_r + 4000kHz$
18	Ageing	$\frac{\Delta f}{f}$	- 10	+ 10	$10^{-6}$	10 years after Burn-in
19	Terminal Length	L	Figure 2		mm	
20	Intended Application		-			

**TABLE 1(a) - TYPE VARIANT DETAILED INFORMATION**

**TYPE VARIANT NO. 74**

No.	Characteristics	Symbol	Limits		Unit	Remarks
			Min.	Max.		
1	Resonance Frequency	$f_r$	70.965082		MHz	
2	Reference Temperature	$T_o$	+20	+30	°C	
3	Overtone Order	-	3			
4	Load Capacitance	$C_L$	$\infty$		pF	
5	Rated Drive Level	$P_o$	0.1		mW	
6	Frequency Adjustment Tolerance	$\frac{\Delta f}{f}$	-10	+10	$10^{-6}$	At $T_o$ °C
7	Resonance Resistance	$R_r$	-	40	$\Omega$	At $T_o$ °C
8	Frequency Variation with Temperature over $T_{op}$	$\frac{\Delta f}{f}$	0 -9.0 -9.0	+9.0 +9.0 0	$10^{-6}$	From T -25 to +10 °C From T +10 to +50 °C From T +50 to +70 °C
9	Resistance Variation with Temperature over $T_{op}$	$\frac{\Delta R}{R}$	-20	+20	%	From resistance measured at $T_o$ °C
10	Operating Temperature Range	$T_{op}$	-25	+70	°C	
11	Frequency variation with Drive Level	$\frac{\Delta f}{f}$	Not applicable		$10^{-6}$	
12	Resistance variation with Drive Level	$\frac{\Delta R}{R}$	Not applicable		%	
13	Motional Inductance	$L_1$	4.5	-	mH	
14	Motional Capacitance	$C_1$	Not applicable		fF	
15	Static Capacitance	$C_o$	-	5.0	pF	
16	Q Factor	Q	70 000	-	-	
17	Ratio of Unwanted: Response Resistance to Resonance Resistance or Response Impedance to Resonance Resistance	$R_p/R$ or $ Z_p /R$	2:1	-		In the frequency range: $f_r - 7000\text{kHz}$ to $f_r + 7000\text{kHz}$
18	Ageing	$\frac{\Delta f}{f}$	-3.0	+3.0	$10^{-6}$	10 years after Burn-in + Ageing of 500 hours
19	Terminal Length	L	Figure 2		mm	
20	Intended Application		-			



**TABLE 1(a) - TYPE VARIANT DETAILED INFORMATION**

TYPE VARIANT NO. 75

No.	Characteristics	Symbol	Limits		Unit	Remarks
			Min.	Max.		
1	Resonance Frequency	$f_r$	79.937158		MHz	
2	Reference Temperature	$T_o$	+ 60	+ 70	°C	
3	Overtone Order	-	3			
4	Load Capacitance	$C_L$	$\infty$		pF	
5	Rated Drive Level	$P_o$	0.1		mW	
6	Frequency Adjustment Tolerance	$\frac{\Delta f}{f}$	- 10	+ 10	$10^{-6}$	At $T_o$ °C
7	Resonance Resistance	$R_r$	-	40	$\Omega$	At $T_o$ °C
8	Frequency Variation with Temperature over $T_{op}$	$\frac{\Delta f}{f}$	Not applicable		$10^{-6}$	
9	Resistance Variation with Temperature over $T_{op}$	$\frac{\Delta R}{R}$	- 20	+ 20	%	From resistance measured at $T_o$ °C
10	Operating Temperature Range	$T_{op}$	- 20	+ 80	°C	
11	Frequency variation with Drive Level	$\frac{\Delta f}{f}$	Not applicable		$10^{-6}$	
12	Resistance variation with Drive Level	$\frac{\Delta R}{R}$	Not applicable		%	
13	Motional Inductance	$L_1$	2.0	-	mH	
14	Motional Capacitance	$C_1$	Not applicable		fF	
15	Static Capacitance	$C_o$	-	5.0	pF	
16	Q Factor	Q	70 000	-	-	
17	Ratio of Unwanted: Response Resistance to Resonance Resistance or Response Impedance to Resonance Resistance	$R_p/R$ or $ Z_p /R$	2:1	-		In the frequency range: $f_r - 7993\text{kHz}$ to $f_r + 7993\text{kHz}$
18	Ageing	$\frac{\Delta f}{f}$	- 3.0	+ 3.0	$10^{-6}$	12 years after Burn-in + Ageing of 500 hours
19	Terminal Length	L	Figure 2		mm	
20	Intended Application		-			



**TABLE 1(a) - TYPE VARIANT DETAILED INFORMATION**

TYPE VARIANT NO. 76

No.	Characteristics	Symbol	Limits		Unit	Remarks
			Min.	Max.		
1	Resonance Frequency	$f_r$	79.745355		MHz	
2	Reference Temperature	$T_o$	+ 60	+ 70	°C	
3	Overtone Order	-	3			
4	Load Capacitance	$C_L$	$\infty$		pF	
5	Rated Drive Level	$P_o$	0.1		mW	
6	Frequency Adjustment Tolerance	$\frac{\Delta f}{f}$	- 10	+ 10	$10^{-6}$	At $T_o$ °C
7	Resonance Resistance	$R_r$	-	40	$\Omega$	At $T_o$ °C
8	Frequency Variation with Temperature over $T_{op}$	$\frac{\Delta f}{f}$	Not applicable		$10^{-6}$	
9	Resistance Variation with Temperature over $T_{op}$	$\frac{\Delta R}{R}$	- 20	+ 20	%	From resistance measured at $T_o$ °C
10	Operating Temperature Range	$T_{op}$	- 20	+ 80	°C	
11	Frequency variation with Drive Level	$\frac{\Delta f}{f}$	Not applicable		$10^{-6}$	
12	Resistance variation with Drive Level	$\frac{\Delta R}{R}$	Not applicable		%	
13	Motional Inductance	$L_1$	2.0	-	mH	
14	Motional Capacitance	$C_1$	Not applicable		fF	
15	Static Capacitance	$C_o$	-	5.0	pF	
16	Q Factor	Q	70 000	-	-	
17	Ratio of Unwanted: Response Resistance to Resonance Resistance or Response Impedance to Resonance Resistance	$R_p/R$ or $ Z_p /R$	2:1	-		In the frequency range: $f_r - 7994\text{kHz}$ to $f_r + 7994\text{kHz}$
18	Ageing	$\frac{\Delta f}{f}$	- 3.0	+ 3.0	$10^{-6}$	12 years after Burn-in + Ageing of 500 hours
19	Terminal Length	L	Figure 2		mm	
20	Intended Application		-			



**TABLE 1(a) - TYPE VARIANT DETAILED INFORMATION**

TYPE VARIANT NO. 77

No.	Characteristics	Symbol	Limits		Unit	Remarks
			Min.	Max.		
1	Resonance Frequency	$f_r$	59.356136		MHz	
2	Reference Temperature	$T_o$	+20	+30	°C	
3	Overtone Order	-	3			
4	Load Capacitance	$C_L$	$\infty$		pF	
5	Rated Drive Level	$P_o$	0.1		mW	
6	Frequency Adjustment Tolerance	$\frac{\Delta f}{f}$	-10	+10	$10^{-6}$	At $T_o$ °C
7	Resonance Resistance	$R_r$	-	40	$\Omega$	At $T_o$ °C
8	Frequency Variation with Temperature over $T_{op}$	$\frac{\Delta f}{f}$	0 -9.0 -9.0	+9.0 +9.0 0	$10^{-6}$	From T -25 to +10 °C From T +10 to +50 °C From T +50 to +70 °C
9	Resistance Variation with Temperature over $T_{op}$	$\frac{\Delta R}{R}$	-20	+20	%	From resistance measured at $T_o$ °C
10	Operating Temperature Range	$T_{op}$	-25	+70	°C	
11	Frequency variation with Drive Level	$\frac{\Delta f}{f}$	-0.5	+0.5	$10^{-6}$	From $P_{S1} = 0.01mW$ to $P_{S2} = 0.1mW$
12	Resistance variation with Drive Level	$\frac{\Delta R}{R}$	-20	+20	%	From $P_{S1} = 0.01mW$ to $P_{S2} = 0.1mW$
13	Motional Inductance	$L_1$	3.0	-	mH	
14	Motional Capacitance	$C_1$	Not applicable		fF	
15	Static Capacitance	$C_o$	-	5.0	pF	
16	Q Factor	Q	70 000	-	-	
17	Ratio of Unwanted: Response Resistance to Resonance Resistance or Response Impedance to Resonance Resistance	$R_p/R$ or $ Z_p /R$	4:1	-		In the frequency range: $f_r - 5800kHz$ to $f_r + 5800kHz$
18	Ageing	$\frac{\Delta f}{f}$	-10	+10	$10^{-6}$	10 years after Burn-in
19	Terminal Length	L	Figure 2		mm	
20	Intended Application		-			

**TABLE 1(a) - TYPE VARIANT DETAILED INFORMATION**

**TYPE VARIANT NO. 78**

No.	Characteristics	Symbol	Limits		Unit	Remarks
			Min.	Max.		
1	Resonance Frequency	$f_L$	18.0		MHz	
2	Reference Temperature	$T_o$	+ 23	+ 27	°C	
3	Overtone Order	-	Fundamental			
4	Load Capacitance	$C_L$	30		pF	
5	Rated Drive Level	$P_o$	0.1		mW	
6	Frequency Adjustment Tolerance	$\frac{\Delta f}{f}$	- 10	+ 10	$10^{-6}$	At $T_o$ °C
7	Resonance Resistance	$R_L$	-	20	$\Omega$	At $T_o$ °C
8	Frequency Variation with Temperature over $T_{op}$	$\frac{\Delta f}{f}$	- 25	+ 25	$10^{-6}$	From frequency measured at $T_o$ °C
9	Resistance Variation with Temperature over $T_{op}$	$\frac{\Delta R}{R}$	Not applicable		%	
10	Operating Temperature Range	$T_{op}$	- 55	+ 100	°C	
11	Frequency variation with Drive Level	$\frac{\Delta f}{f}$	Not applicable		$10^{-6}$	
12	Resistance variation with Drive Level	$\frac{\Delta R}{R}$	Not applicable		%	
13	Motional Inductance	$L_1$	Not applicable		mH	
14	Motional Capacitance	$C_1$	Not applicable		fF	
15	Static Capacitance	$C_o$	-	7.0	pF	
16	Q Factor	Q	90 000	-	-	
17	Ratio of Unwanted: Response Resistance to Resonance Resistance or Response Impedance to Resonance Resistance	$R_p/R$ or $ Z_p /R$	2:1	-		In the frequency range: $f_L - 500\text{kHz}$ to $f_L + 500\text{kHz}$
18	Ageing	$\frac{\Delta f}{f}$	- 5.0	+ 5.0	$10^{-6}$	Per year after Burn-in
19	Terminal Length	L	Figure 2		mm	
20	Intended Application		-			

**TABLE 1(a) - TYPE VARIANT DETAILED INFORMATION**

TYPE VARIANT NO. 79

No.	Characteristics	Symbol	Limits		Unit	Remarks
			Min.	Max.		
1	Resonance Frequency	$f_r$	81.576923		MHz	
2	Reference Temperature	$T_o$	+ 62	+ 72	°C	
3	Overtone Order	-	3			
4	Load Capacitance	$C_L$	$\infty$		pF	
5	Rated Drive Level	$P_o$	0.1		mW	
6	Frequency Adjustment Tolerance	$\frac{\Delta f}{f}$	- 10	+ 10	$10^{-6}$	At $T_o$ °C
7	Resonance Resistance	$R_r$	-	40	$\Omega$	At $T_o$ °C
8	Frequency Variation with Temperature over $T_{op}$	$\frac{\Delta f}{f}$	Not applicable		$10^{-6}$	
9	Resistance Variation with Temperature over $T_{op}$	$\frac{\Delta R}{R}$	- 20	+ 20	%	From resistance measured at $T_o$ °C
10	Operating Temperature Range	$T_{op}$	- 20	+ 80	°C	
11	Frequency variation with Drive Level	$\frac{\Delta f}{f}$	Not applicable		$10^{-6}$	
12	Resistance variation with Drive Level	$\frac{\Delta R}{R}$	Not applicable		%	
13	Motional Inductance	$L_1$	2.0	-	mH	
14	Motional Capacitance	$C_1$	Not applicable		fF	
15	Static Capacitance	$C_o$	-	5.0	pF	
16	Q Factor	Q	70 000	-	-	
17	Ratio of Unwanted: Response Resistance to Resonance Resistance or Response Impedance to Resonance Resistance	$R_p/R$ or $ Z_p /R$	2:1	-		In the frequency range: $f_r - 10\%$ to $f_r + 10\%$
18	Ageing	$\frac{\Delta f}{f}$	- 3.0	+ 3.0	$10^{-6}$	10 years after 500 hours Burn-in
19	Terminal Length	L	Figure 2		mm	
20	Intended Application		OCXO			

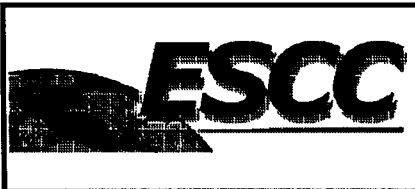


**TABLE 1(a) - TYPE VARIANT DETAILED INFORMATION**

TYPE VARIANT NO. 80

No.	Characteristics	Symbol	Limits		Unit	Remarks
			Min.	Max.		
1	Resonance Frequency	$f_r$	86.024590		MHz	
2	Reference Temperature	$T_o$	+20	+30	°C	
3	Overtone Order	-	3			
4	Load Capacitance	$C_L$	$\infty$		pF	
5	Rated Drive Level	$P_o$	0.1		mW	
6	Frequency Adjustment Tolerance	$\frac{\Delta f}{f}$	-10	+10	$10^{-6}$	At $T_o$ °C
7	Resonance Resistance	$R_r$	-	40	$\Omega$	At $T_o$ °C
8	Frequency Variation with Temperature over $T_{op}$	$\frac{\Delta f}{f}$	0 -9.0 -9.0	+9.0 +9.0 0	$10^{-6}$	From T -20 to +10 °C From T +10 to +50 °C From T +50 to +80 °C
9	Resistance Variation with Temperature over $T_{op}$	$\frac{\Delta R}{R}$	-20	+20	%	From resistance measured at $T_o$ °C
10	Operating Temperature Range	$T_{op}$	-20	+80	°C	
11	Frequency variation with Drive Level	$\frac{\Delta f}{f}$	Not applicable		$10^{-6}$	
12	Resistance variation with Drive Level	$\frac{\Delta R}{R}$	Not applicable		%	
13	Motional Inductance	$L_1$	2.0	-	mH	
14	Motional Capacitance	$C_1$	Not applicable		fF	
15	Static Capacitance	$C_o$	-	5.0	pF	
16	Q Factor	Q	70 000	-	-	
17	Ratio of Unwanted: Response Resistance to Resonance Resistance or Response Impedance to Resonance Resistance	$R_p/R$ or $ Z_p /R$	2:1	-		In the frequency range: $f_r - 10\%$ to $f_r + 10\%$
18	Ageing	$\frac{\Delta f}{f}$	-5.0	+5.0	$10^{-6}$	Over 12 years after Burn-in
19	Terminal Length	L	Figure 2		mm	
20	Intended Application		TCXO			

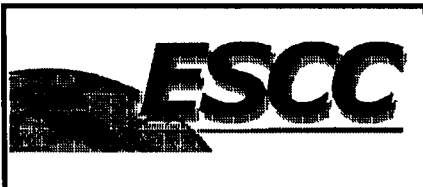




**TABLE 1(a) - TYPE VARIANT DETAILED INFORMATION**

**TYPE VARIANT NO. 81**

No.	Characteristics	Symbol	Limits		Unit	Remarks
			Min.	Max.		
1	Resonance Frequency	$f_r$	85.983607		MHz	
2	Reference Temperature	$T_o$	+20	+30	°C	
3	Overtone Order	-	3			
4	Load Capacitance	$C_L$	$\infty$		pF	
5	Rated Drive Level	$P_o$	0.1		mW	
6	Frequency Adjustment Tolerance	$\frac{\Delta f}{f}$	-10	+10	$10^{-6}$	At $T_o$ °C
7	Resonance Resistance	$R_r$	-	40	$\Omega$	At $T_o$ °C
8	Frequency Variation with Temperature over $T_{op}$	$\frac{\Delta f}{f}$	0 -9.0 -9.0	+9.0 +9.0 0	$10^{-6}$	From T -20 to +10 °C From T +10 to +50 °C From T +50 to +80 °C
9	Resistance Variation with Temperature over $T_{op}$	$\frac{\Delta R}{R}$	-20	+20	%	From resistance measured at $T_o$ °C
10	Operating Temperature Range	$T_{op}$	-20	+80	°C	
11	Frequency variation with Drive Level	$\frac{\Delta f}{f}$	Not applicable		$10^{-6}$	
12	Resistance variation with Drive Level	$\frac{\Delta R}{R}$	Not applicable		%	
13	Motional Inductance	$L_1$	2.0	-	mH	
14	Motional Capacitance	$C_1$	Not applicable		fF	
15	Static Capacitance	$C_o$	-	5.0	pF	
16	Q Factor	Q	70 000	-	-	
17	Ratio of Unwanted: Response Resistance to Resonance Resistance or Response Impedance to Resonance Resistance	$R_p/R$ or $ Z_p /R$	2:1	-		In the frequency range: $f_r - 10\%$ to $f_r + 10\%$
18	Ageing	$\frac{\Delta f}{f}$	-5.0	+5.0	$10^{-6}$	Over 12 years after Burn-in
19	Terminal Length	L	Figure 2		mm	
20	Intended Application		TCXO			



**TABLE 1(a) - TYPE VARIANT DETAILED INFORMATION**

TYPE VARIANT NO. 82

No.	Characteristics	Symbol	Limits		Unit	Remarks
			Min.	Max.		
1	Resonance Frequency	$f_r$	79.949453		MHz	
2	Reference Temperature	$T_o$	+60	+70	°C	
3	Overtone Order	-	3			
4	Load Capacitance	$C_L$	$\infty$		pF	
5	Rated Drive Level	$P_o$	0.1		mW	
6	Frequency Adjustment Tolerance	$\frac{\Delta f}{f}$	-10	+10	$10^{-6}$	At $T_o$ °C
7	Resonance Resistance	$R_r$	-	40	$\Omega$	At $T_o$ °C
8	Frequency Variation with Temperature over $T_{op}$	$\frac{\Delta f}{f}$	Not applicable		$10^{-6}$	
9	Resistance Variation with Temperature over $T_{op}$	$\frac{\Delta R}{R}$	-20	+20	%	From resistance measured at $T_o$ °C
10	Operating Temperature Range	$T_{op}$	-20	+80	°C	
11	Frequency variation with Drive Level	$\frac{\Delta f}{f}$	Not applicable		$10^{-6}$	
12	Resistance variation with Drive Level	$\frac{\Delta R}{R}$	Not applicable		%	
13	Motional Inductance	$L_1$	2.0	-	mH	
14	Motional Capacitance	$C_1$	Not applicable		fF	
15	Static Capacitance	$C_o$	-	5.0	pF	
16	Q Factor	Q	70 000	-	-	
17	Ratio of Unwanted: Response Resistance to Resonance Resistance or Response Impedance to Resonance Resistance	$R_p/R$ or $ Z_p /R$	2:1	-		In the frequency range: $f_r - 10\%$ to $f_r + 10\%$
18	Ageing	$\frac{\Delta f}{f}$	-3.0	+3.0	$10^{-6}$	Over 12 years after 500 hours Burn-in
19	Terminal Length	L	Figure 2		mm	
20	Intended Application		OCXO			



**TABLE 1(a) - TYPE VARIANT DETAILED INFORMATION**

TYPE VARIANT NO. 83

No.	Characteristics	Symbol	Limits		Unit	Remarks
			Min.	Max.		
1	Resonance Frequency	$f_r$	79.957650		MHz	
2	Reference Temperature	$T_o$	+ 60	+ 70	°C	
3	Overtone Order	-	3			
4	Load Capacitance	$C_L$	$\infty$		pF	
5	Rated Drive Level	$P_o$	0.1		mW	
6	Frequency Adjustment Tolerance	$\frac{\Delta f}{f}$	- 10	+ 10	$10^{-6}$	At $T_o$ °C
7	Resonance Resistance	$R_r$	-	40	$\Omega$	At $T_o$ °C
8	Frequency Variation with Temperature over $T_{op}$	$\frac{\Delta f}{f}$	Not applicable		$10^{-6}$	
9	Resistance Variation with Temperature over $T_{op}$	$\frac{\Delta R}{R}$	- 20	+ 20	%	From resistance measured at $T_o$ °C
10	Operating Temperature Range	$T_{op}$	- 20	+ 80	°C	
11	Frequency variation with Drive Level	$\frac{\Delta f}{f}$	Not applicable		$10^{-6}$	
12	Resistance variation with Drive Level	$\frac{\Delta R}{R}$	Not applicable		%	
13	Motional Inductance	$L_1$	2.0	-	mH	
14	Motional Capacitance	$C_1$	Not applicable		fF	
15	Static Capacitance	$C_o$	-	5.0	pF	
16	Q Factor	Q	70 000	-	-	
17	Ratio of Unwanted: Response Resistance to Resonance Resistance or Response Impedance to Resonance Resistance	$R_p/R$ or $ Z_p /R$	2:1	-		In the frequency range: $f_r - 10\%$ to $f_r + 10\%$
18	Ageing	$\frac{\Delta f}{f}$	- 3.0	+ 3.0	$10^{-6}$	Over 12 years after 500 hours Burn-in
19	Terminal Length	L	Figure 2		mm	
20	Intended Application		OCXO			

**TABLE 1(a) - TYPE VARIANT DETAILED INFORMATION**

**TYPE VARIANT NO. 84**

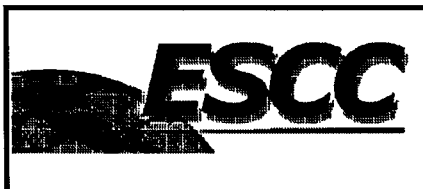
No.	Characteristics	Symbol	Limits		Unit	Remarks
			Min.	Max.		
1	Resonance Frequency	$f_r$	70.970205		MHz	
2	Reference Temperature	$T_o$	+20	+30	°C	
3	Overtone Order	-	3			
4	Load Capacitance	$C_L$	$\infty$		pF	
5	Rated Drive Level	$P_o$	0.1		mW	
6	Frequency Adjustment Tolerance	$\frac{\Delta f}{f}$	-10	+10	$10^{-6}$	At $T_o$ °C
7	Resonance Resistance	$R_r$	-	40	$\Omega$	At $T_o$ °C
8	Frequency Variation with Temperature over $T_{op}$	$\frac{\Delta f}{f}$	0 -9.0 -9.0	+9.0 +9.0 0	$10^{-6}$	From T -20 to +10 °C From T +10 to +50 °C From T +50 to +80 °C
9	Resistance Variation with Temperature over $T_{op}$	$\frac{\Delta R}{R}$	-20	+20	%	From resistance measured at $T_o$ °C
10	Operating Temperature Range	$T_{op}$	-25	+70	°C	
11	Frequency variation with Drive Level	$\frac{\Delta f}{f}$	Not applicable		$10^{-6}$	
12	Resistance variation with Drive Level	$\frac{\Delta R}{R}$	Not applicable		%	
13	Motional Inductance	$L_1$	4.5	-	mH	
14	Motional Capacitance	$C_1$	Not applicable		fF	
15	Static Capacitance	$C_o$	-	5.0	pF	
16	Q Factor	Q	70 000	-	-	
17	Ratio of Unwanted: Response Resistance to Resonance Resistance or Response Impedance to Resonance Resistance	$R_p/R$ or $ Z_p /R$	2:1	-		In the frequency range: $f_r - 10\%$ to $f_r + 10\%$
18	Ageing	$\frac{\Delta f}{f}$	-3.0	+3.0	$10^{-6}$	Over 12 years after 500 hours Burn-in
19	Terminal Length	L	Figure 2		mm	
20	Intended Application		TCXO			



**TABLE 1(a) - TYPE VARIANT DETAILED INFORMATION**

**TYPE VARIANT NO. 85**

No.	Characteristics	Symbol	Limits		Unit	Remarks
			Min.	Max.		
1	Resonance Frequency	$f_L$	101.936620		MHz	
2	Reference Temperature	$T_o$	+23	+27	°C	
3	Overtone Order	-	5			
4	Load Capacitance	$C_L$	11.9	12.1	pF	
5	Rated Drive Level	$P_o$	0.1		mW	
6	Frequency Adjustment Tolerance	$\frac{\Delta f}{f}$	-5.0	+5.0	$10^{-4}$	At $T_o$ °C
7	Resonance Resistance	$R_L$	-	70	$\Omega$	Over $T_{op}$ °C
8	Frequency Variation with Temperature over $T_{op}$	$\frac{\Delta f}{f}$	-5.0 -10	+5.0 +10	$10^{-4}$	From $T - 20^\circ\text{C}$ to $+70^\circ\text{C}$ From $T - 20^\circ\text{C}$ to $+80^\circ\text{C}$
9	Resistance Variation with Temperature over $T_{op}$	$\frac{\Delta R}{R}$	Not applicable		%	
10	Operating Temperature Range	$T_{op}$	-20	+80	°C	
11	Frequency variation with Drive Level	$\frac{\Delta f}{f}$	Not applicable		$10^{-4}$	
12	Resistance variation with Drive Level	$\frac{\Delta R}{R}$	Not applicable		%	
13	Motional Inductance	$L_1$	Not applicable		mH	
14	Motional Capacitance	$C_1$	0.37	-	fF	
15	Static Capacitance	$C_o$	-	5.0	pF	
16	Q Factor	Q	60 000	-	-	
17	Ratio of Unwanted: Response Resistance to Resonance Resistance or Response Impedance to Resonance Resistance	$R_p/R$ or $ Z_p /R$	2.5:1	-		In the frequency range: $f_L - 100\text{kHz}$ to $f_L + 100\text{kHz}$
18	Ageing	$\frac{\Delta f}{f}$	-6.0	+6.0	$10^{-4}$	Over 5 years
19	Terminal Length	L	Figure 2		mm	
20	Intended Application		VCXO			



**TABLE 1(a) - TYPE VARIANT DETAILED INFORMATION**

TYPE VARIANT NO. 86

No.	Characteristics	Symbol	Limits		Unit	Remarks
			Min.	Max.		
1	Resonance Frequency	$f_L$	75.0		MHz	
2	Reference Temperature	$T_o$	+23	+27	°C	
3	Overtone Order	-	3			
4	Load Capacitance	$C_L$	11.9	12.1	pF	
5	Rated Drive Level	$P_o$	0.1		mW	
6	Frequency Adjustment Tolerance	$\frac{\Delta f}{f}$	-2.0	+2.0	$10^{-4}$	At $T_o$ °C
7	Resonance Resistance	$R_L$	-	25	$\Omega$	Over $T_{op}$ °C
8	Frequency Variation with Temperature over $T_{op}$	$\frac{\Delta f}{f}$	-5.0 -10	+5.0 +10	$10^{-4}$	From $T - 20^\circ\text{C}$ to $+70^\circ\text{C}$ From $T - 20^\circ\text{C}$ to $+80^\circ\text{C}$
9	Resistance Variation with Temperature over $T_{op}$	$\frac{\Delta R}{R}$	Not applicable		%	
10	Operating Temperature Range	$T_{op}$	-20	+80	°C	
11	Frequency variation with Drive Level	$\frac{\Delta f}{f}$	Not applicable		$10^{-4}$	
12	Resistance variation with Drive Level	$\frac{\Delta R}{R}$	Not applicable		%	
13	Motional Inductance	$L_1$	Not applicable		mH	
14	Motional Capacitance	$C_1$	1.7	-	fF	
15	Static Capacitance	$C_o$	-	6.0	pF	
16	Q Factor	Q	50 000	-	-	
17	Ratio of Unwanted: Response Resistance to Resonance Resistance or Response Impedance to Resonance Resistance	$R_p/R$ or $ Z_p /R$	2.5:1	-		In the frequency range: $f_L - 100\text{kHz}$ to $f_L + 100\text{kHz}$
18	Ageing	$\frac{\Delta f}{f}$	-6.0	+6.0	$10^{-4}$	Over 5 years
19	Terminal Length	L	Figure 2		mm	
20	Intended Application		VCXO			



**TABLE 1(a) - TYPE VARIANT DETAILED INFORMATION**

TYPE VARIANT NO. 87

No.	Characteristics	Symbol	Limits		Unit	Remarks
			Min.	Max.		
1	Resonance Frequency	$f_L$	80.0		MHz	
2	Reference Temperature	$T_o$	+23	+27	°C	
3	Overtone Order	-	3			
4	Load Capacitance	$C_L$	11.9	12.1	pF	
5	Rated Drive Level	$P_o$	0.1		mW	
6	Frequency Adjustment Tolerance	$\frac{\Delta f}{f}$	-2.0	+2.0	$10^{-4}$	At $T_o$ °C
7	Resonance Resistance	$R_L$	-	25	$\Omega$	Over $T_{op}$ °C
8	Frequency Variation with Temperature over $T_{op}$	$\frac{\Delta f}{f}$	-5.0 -10	+5.0 +10	$10^{-4}$	From $T - 20^\circ\text{C}$ to $+70^\circ\text{C}$ From $T - 20^\circ\text{C}$ to $+80^\circ\text{C}$
9	Resistance Variation with Temperature over $T_{op}$	$\frac{\Delta R}{R}$	Not applicable		%	
10	Operating Temperature Range	$T_{op}$	-20	+80	°C	
11	Frequency variation with Drive Level	$\frac{\Delta f}{f}$	Not applicable		$10^{-4}$	
12	Resistance variation with Drive Level	$\frac{\Delta R}{R}$	Not applicable		%	
13	Motional Inductance	$L_1$	Not applicable		mH	
14	Motional Capacitance	$C_1$	1.7	-	fF	
15	Static Capacitance	$C_o$	-	6.0	pF	
16	Q Factor	Q	50 000	-	-	
17	Ratio of Unwanted: Response Resistance to Resonance Resistance or Response Impedance to Resonance Resistance	$R_p/R$ or $ Z_p /R$	2.5:1	-		In the frequency range: $f_L - 100\text{kHz}$ to $f_L + 100\text{kHz}$
18	Ageing	$\frac{\Delta f}{f}$	-6.0	+6.0	$10^{-4}$	Over 5 years
19	Terminal Length	L	Figure 2		mm	
20	Intended Application		VCXO			



**TABLE 1(a) - TYPE VARIANT DETAILED INFORMATION**

TYPE VARIANT NO. 88

No.	Characteristics	Symbol	Limits		Unit	Remarks
			Min.	Max.		
1	Resonance Frequency	$f_r$	74.626318		MHz	
2	Reference Temperature	$T_o$	+20	+30	°C	
3	Overtone Order	-	3			
4	Load Capacitance	$C_L$	$\infty$		pF	
5	Rated Drive Level	$P_o$	0.1		mW	
6	Frequency Adjustment Tolerance	$\frac{\Delta f}{f}$	-10	+10	$10^{-6}$	At $T_o$ °C
7	Resonance Resistance	$R_r$	-	40	$\Omega$	At $T_o$ °C
8	Frequency Variation with Temperature over $T_{op}$	$\frac{\Delta f}{f}$	0 -9.0 -9.0	+9.0 +9.0 0	$10^{-6}$	From T -20 to +10 °C From T +10 to +50 °C From T +50 to +80 °C
9	Resistance Variation with Temperature over $T_{op}$	$\frac{\Delta R}{R}$	-20	+20	%	From resistance measured at $T_o$ °C
10	Operating Temperature Range	$T_{op}$	-20	+80	°C	
11	Frequency variation with Drive Level	$\frac{\Delta f}{f}$	Not applicable		$10^{-6}$	
12	Resistance variation with Drive Level	$\frac{\Delta R}{R}$	Not applicable		%	
13	Motional Inductance	$L_1$	2.0	-	mH	
14	Motional Capacitance	$C_1$	Not applicable		fF	
15	Static Capacitance	$C_o$	-	5.0	pF	
16	Q Factor	Q	70 000	-	-	
17	Ratio of Unwanted: Response Resistance to Resonance Resistance or Response Impedance to Resonance Resistance	$R_p/R$ or $ Z_p /R$	2:1	-		In the frequency range: $f_r - 10\%$ to $f_r + 10\%$
18	Ageing	$\frac{\Delta f}{f}$	-3.0	+3.0	$10^{-6}$	12 years after 500 hours Burn-in
19	Terminal Length	L	Figure 2		mm	
20	Intended Application		TCXO			

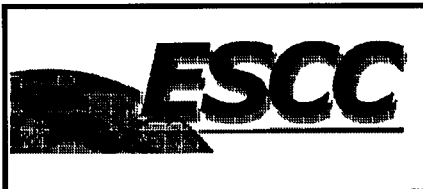




**TABLE 1(a) - TYPE VARIANT DETAILED INFORMATION**

TYPE VARIANT NO. 89

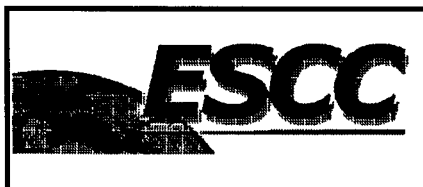
No.	Characteristics	Symbol	Limits		Unit	Remarks
			Min.	Max.		
1	Resonance Frequency	$f_r$	64.791785		MHz	
2	Reference Temperature	$T_o$	+20	+30	°C	
3	Overtone Order	-	3			
4	Load Capacitance	$C_L$	$\infty$		pF	
5	Rated Drive Level	$P_o$	0.1		mW	
6	Frequency Adjustment Tolerance	$\frac{\Delta f}{f}$	-10	+10	$10^{-6}$	At $T_o$ °C
7	Resonance Resistance	$R_r$	-	40	$\Omega$	At $T_o$ °C
8	Frequency Variation with Temperature over $T_{op}$	$\frac{\Delta f}{f}$	0 -9.0 -9.0	+9.0 +9.0 0	$10^{-6}$	From T -20 to +10 °C From T +10 to +50 °C From T +50 to +80 °C
9	Resistance Variation with Temperature over $T_{op}$	$\frac{\Delta R}{R}$	-20	+20	%	From resistance measured at $T_o$ °C
10	Operating Temperature Range	$T_{op}$	-20	+80	°C	
11	Frequency variation with Drive Level	$\frac{\Delta f}{f}$	Not applicable		$10^{-6}$	
12	Resistance variation with Drive Level	$\frac{\Delta R}{R}$	Not applicable		%	
13	Motional Inductance	$L_1$	2.0	-	mH	
14	Motional Capacitance	$C_1$	Not applicable		fF	
15	Static Capacitance	$C_o$	-	5.0	pF	
16	Q Factor	Q	70 000	-	-	
17	Ratio of Unwanted: Response Resistance to Resonance Resistance or Response Impedance to Resonance Resistance	$R_p/R$ or $ Z_p /R$	2:1	-		In the frequency range: $f_r - 10\%$ to $f_r + 10\%$
18	Ageing	$\frac{\Delta f}{f}$	-3.0	+3.0	$10^{-6}$	12 years after 500 hours Burn-in
19	Terminal Length	L	Figure 2		mm	
20	Intended Application		TCXO			



**TABLE 1(a) - TYPE VARIANT DETAILED INFORMATION**

TYPE VARIANT NO. 90

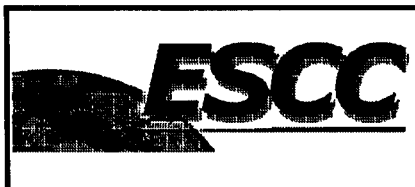
No.	Characteristics	Symbol	Limits		Unit	Remarks
			Min.	Max.		
1	Resonance Frequency	$f_r$	64.990091		MHz	
2	Reference Temperature	$T_o$	+ 20	+ 30	°C	
3	Overtone Order	-	3			
4	Load Capacitance	$C_L$	$\infty$		pF	
5	Rated Drive Level	$P_o$	0.1		mW	
6	Frequency Adjustment Tolerance	$\frac{\Delta f}{f}$	- 10	+ 10	$10^{-6}$	At $T_o$ °C
7	Resonance Resistance	$R_r$	-	40	$\Omega$	At $T_o$ °C
8	Frequency Variation with Temperature over $T_{op}$	$\frac{\Delta f}{f}$	0 - 9.0 - 9.0	+ 9.0 + 9.0 0	$10^{-6}$	From T - 20 to + 10 °C From T + 10 to + 50 °C From T + 50 to + 80 °C
9	Resistance Variation with Temperature over $T_{op}$	$\frac{\Delta R}{R}$	- 20	+ 20	%	From resistance measured at $T_o$ °C
10	Operating Temperature Range	$T_{op}$	- 20	+ 80	°C	
11	Frequency variation with Drive Level	$\frac{\Delta f}{f}$	Not applicable		$10^{-6}$	
12	Resistance variation with Drive Level	$\frac{\Delta R}{R}$	Not applicable		%	
13	Motional Inductance	$L_1$	2.0	-	mH	
14	Motional Capacitance	$C_1$	Not applicable		fF	
15	Static Capacitance	$C_o$	-	5.0	pF	
16	Q Factor	Q	70 000	-	-	
17	Ratio of Unwanted: Response Resistance to Resonance Resistance or Response Impedance to Resonance Resistance	$R_p/R$ or $ Z_p /R$	2:1	-		In the frequency range: $f_r - 10\%$ to $f_r + 10\%$
18	Ageing	$\frac{\Delta f}{f}$	- 3.0	+ 3.0	$10^{-6}$	Over 12 years after 500 hours Burn-in
19	Terminal Length	L	Figure 2		mm	
20	Intended Application		TCXO			



**TABLE 1(a) - TYPE VARIANT DETAILED INFORMATION**

TYPE VARIANT NO. 91

No.	Characteristics	Symbol	Limits		Unit	Remarks
			Min.	Max.		
1	Resonance Frequency	$f_r$	64.995773		MHz	
2	Reference Temperature	$T_o$	+ 20	+ 30	°C	
3	Overtone Order	-	3			
4	Load Capacitance	$C_L$	$\infty$		pF	
5	Rated Drive Level	$P_o$	0.1		mW	
6	Frequency Adjustment Tolerance	$\frac{\Delta f}{f}$	- 10	+ 10	$10^{-6}$	At $T_o$ °C
7	Resonance Resistance	$R_r$	-	40	$\Omega$	At $T_o$ °C
8	Frequency Variation with Temperature over $T_{op}$	$\frac{\Delta f}{f}$	0 - 9.0 - 9.0	+ 9.0 + 9.0 0	$10^{-6}$	From T - 20 to + 10 °C From T + 10 to + 50 °C From T + 50 to + 80 °C
9	Resistance Variation with Temperature over $T_{op}$	$\frac{\Delta R}{R}$	- 20	+ 20	%	From resistance measured at $T_o$ °C
10	Operating Temperature Range	$T_{op}$	- 20	+ 80	°C	
11	Frequency variation with Drive Level	$\frac{\Delta f}{f}$	Not applicable		$10^{-6}$	
12	Resistance variation with Drive Level	$\frac{\Delta R}{R}$	Not applicable		%	
13	Motional Inductance	$L_1$	2.0	-	mH	
14	Motional Capacitance	$C_1$	Not applicable		fF	
15	Static Capacitance	$C_o$	-	5.0	pF	
16	Q Factor	Q	70 000	-	-	
17	Ratio of Unwanted: Response Resistance to Resonance Resistance or Response Impedance to Resonance Resistance	$R_p/R$ or $ Z_p /R$	2:1	-		In the frequency range: $f_r - 10\%$ to $f_r + 10\%$
18	Ageing	$\frac{\Delta f}{f}$	- 3.0	+ 3.0	$10^{-6}$	12 years after 500 hours Burn-in
19	Terminal Length	L	Figure 2		mm	
20	Intended Application		TCXO			



**TABLE 1(a) - TYPE VARIANT DETAILED INFORMATION**

TYPE VARIANT NO. 92

No.	Characteristics	Symbol	Limits		Unit	Remarks
			Min.	Max.		
1	Resonance Frequency	$f_r$	74.677455		MHz	
2	Reference Temperature	$T_o$	+20	+30	°C	
3	Overtone Order	-	3			
4	Load Capacitance	$C_L$	$\infty$		pF	
5	Rated Drive Level	$P_o$	0.1		mW	
6	Frequency Adjustment Tolerance	$\frac{\Delta f}{f}$	-10	+10	$10^{-6}$	At $T_o$ °C
7	Resonance Resistance	$R_r$	-	40	$\Omega$	At $T_o$ °C
8	Frequency Variation with Temperature over $T_{op}$	$\frac{\Delta f}{f}$	0 -9.0 -9.0	+9.0 +9.0 0	$10^{-6}$	From T -20 to +10 °C From T +10 to +50 °C From T +50 to +80 °C
9	Resistance Variation with Temperature over $T_{op}$	$\frac{\Delta R}{R}$	-20	+20	%	From resistance measured at $T_o$ °C
10	Operating Temperature Range	$T_{op}$	-20	+80	°C	
11	Frequency variation with Drive Level	$\frac{\Delta f}{f}$	Not applicable		$10^{-6}$	
12	Resistance variation with Drive Level	$\frac{\Delta R}{R}$	Not applicable		%	
13	Motional Inductance	$L_1$	2.0	-	mH	
14	Motional Capacitance	$C_1$	Not applicable		fF	
15	Static Capacitance	$C_o$	-	5.0	pF	
16	Q Factor	Q	70 000	-	-	
17	Ratio of Unwanted: Response Resistance to Resonance Resistance or Response Impedance to Resonance Resistance	$R_p/R$ or $ Z_p /R$	2:1	-		In the frequency range: $f_r - 10\%$ to $f_r + 10\%$
18	Ageing	$\frac{\Delta f}{f}$	-3.0	+3.0	$10^{-6}$	12 years after 500 hours Burn-in
19	Terminal Length	L	Figure 2		mm	
20	Intended Application		TCXO			



**TABLE 1(a) - TYPE VARIANT DETAILED INFORMATION**

**TYPE VARIANT NO. 93**

No.	Characteristics	Symbol	Limits		Unit	Remarks
			Min.	Max.		
1	Resonance Frequency	$f_r$	66.638308		MHz	
2	Reference Temperature	$T_o$	+20	+30	°C	
3	Overtone Order	-	3			
4	Load Capacitance	$C_L$	$\infty$		pF	
5	Rated Drive Level	$P_o$	0.1		mW	
6	Frequency Adjustment Tolerance	$\frac{\Delta f}{f}$	-10	+10	$10^{-6}$	At $T_o$ °C
7	Resonance Resistance	$R_r$	-	40	$\Omega$	At $T_o$ °C
8	Frequency Variation with Temperature over $T_{op}$	$\frac{\Delta f}{f}$	0 -9.0 -9.0	+9.0 +9.0 0	$10^{-6}$	From T -20 to +10 °C From T +10 to +50 °C From T +50 to +80 °C
9	Resistance Variation with Temperature over $T_{op}$	$\frac{\Delta R}{R}$	-20	+20	%	From resistance measured at $T_o$ °C
10	Operating Temperature Range	$T_{op}$	-20	+80	°C	
11	Frequency variation with Drive Level	$\frac{\Delta f}{f}$	Not applicable		$10^{-6}$	
12	Resistance variation with Drive Level	$\frac{\Delta R}{R}$	Not applicable		%	
13	Motional Inductance	$L_1$	6.5	-	mH	
14	Motional Capacitance	$C_1$	Not applicable		fF	
15	Static Capacitance	$C_o$	-	5.0	pF	
16	Q Factor	Q	90 000	-	-	
17	Ratio of Unwanted: Response Resistance to Resonance Resistance or Response Impedance to Resonance Resistance	$R_p/R$ or $ Z_p /R$	2:1	-		In the frequency range: $f_r - 10\%$ to $f_r + 10\%$
18	Ageing	$\frac{\Delta f}{f}$	-3.0	+3.0	$10^{-6}$	12 years after 500 hours Burn-in
19	Terminal Length	L	Figure 2		mm	
20	Intended Application		TCXO			



**TABLE 1(a) - TYPE VARIANT DETAILED INFORMATION**

TYPE VARIANT NO. 94

No.	Characteristics	Symbol	Limits		Unit	Remarks
			Min.	Max.		
1	Resonance Frequency	$f_r$	66.628692		MHz	
2	Reference Temperature	$T_o$	+20	+30	°C	
3	Overtone Order	-	3			
4	Load Capacitance	$C_L$	$\infty$		pF	
5	Rated Drive Level	$P_o$	0.1		mW	
6	Frequency Adjustment Tolerance	$\frac{\Delta f}{f}$	-10	+10	$10^{-6}$	At $T_o$ °C
7	Resonance Resistance	$R_r$	-	40	$\Omega$	At $T_o$ °C
8	Frequency Variation with Temperature over $T_{op}$	$\frac{\Delta f}{f}$	0 -9.0 -9.0	+9.0 +9.0 0	$10^{-6}$	From T -20 to +10 °C From T +10 to +50 °C From T +50 to +80 °C
9	Resistance Variation with Temperature over $T_{op}$	$\frac{\Delta R}{R}$	-20	+20	%	From resistance measured at $T_o$ °C
10	Operating Temperature Range	$T_{op}$	-20	+80	°C	
11	Frequency variation with Drive Level	$\frac{\Delta f}{f}$	Not applicable		$10^{-6}$	
12	Resistance variation with Drive Level	$\frac{\Delta R}{R}$	Not applicable		%	
13	Motional Inductance	$L_1$	6.5	-	mH	
14	Motional Capacitance	$C_1$	Not applicable		fF	
15	Static Capacitance	$C_o$	-	5.0	pF	
16	Q Factor	Q	90 000	-	-	
17	Ratio of Unwanted: Response Resistance to Resonance Resistance or Response Impedance to Resonance Resistance	$R_p/R$ or $ Z_p /R$	2:1	-		In the frequency range: $f_r - 10\%$ to $f_r + 10\%$
18	Ageing	$\frac{\Delta f}{f}$	-3.0	+3.0	$10^{-6}$	12 years after 500 hours Burn-in
19	Terminal Length	L	Figure 2		mm	
20	Intended Application		TCXO			



**TABLE 1(a) - TYPE VARIANT DETAILED INFORMATION**

TYPE VARIANT NO. 95

No.	Characteristics	Symbol	Limits		Unit	Remarks
			Min.	Max.		
1	Resonance Frequency	$f_r$	60.091346		MHz	
2	Reference Temperature	$T_o$	+20	+30	°C	
3	Overtone Order	-	3			
4	Load Capacitance	$C_L$	$\infty$		pF	
5	Rated Drive Level	$P_o$	0.1		mW	
6	Frequency Adjustment Tolerance	$\frac{\Delta f}{f}$	-10	+10	$10^{-6}$	At $T_o$ °C
7	Resonance Resistance	$R_r$	-	40	$\Omega$	At $T_o$ °C
8	Frequency Variation with Temperature over $T_{op}$	$\frac{\Delta f}{f}$	0 -9.0 -9.0	+9.0 +9.0 0	$10^{-6}$	From T -20 to +10 °C From T +10 to +50 °C From T +50 to +80 °C
9	Resistance Variation with Temperature over $T_{op}$	$\frac{\Delta R}{R}$	-2.0	+2.0	$\Omega$	From resistance measured at $T_o$ °C
10	Operating Temperature Range	$T_{op}$	-20	+80	°C	
11	Frequency variation with Drive Level	$\frac{\Delta f}{f}$	-0.5	+0.5	$10^{-6}$	From $P_{S1} = 0.01mW$ to $P_{S2} = 0.1mW$
12	Resistance variation with Drive Level	$\frac{\Delta R}{R}$	-20	+20	%	From $P_{S1} = 0.01mW$ to $P_{S2} = 0.1mW$
13	Motional Inductance	$L_1$	3.0	-	mH	
14	Motional Capacitance	$C_1$	Not applicable		fF	
15	Static Capacitance	$C_o$	-	5.0	pF	
16	Q Factor	Q	70 000	-	-	
17	Ratio of Unwanted: Response Resistance to Resonance Resistance or Response Impedance to Resonance Resistance	$R_p/R$ or $ Z_p /R$	3:1	-		In the frequency range: $f_r - 10\%$ to $f_r + 10\%$
18	Ageing	$\frac{\Delta f}{f}$	-3.0	+3.0	$10^{-6}$	12 years after 500 hours Burn-in
19	Terminal Length	L	Figure 2		mm	
20	Intended Application		TCXO			

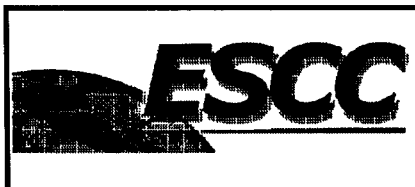


**TABLE 1(a) - TYPE VARIANT DETAILED INFORMATION**

**TYPE VARIANT NO. 96**

No.	Characteristics	Symbol	Limits		Unit	Remarks
			Min.	Max.		
1	Resonance Frequency	$f_r$	60.086538		MHz	
2	Reference Temperature	$T_o$	+20	+30	°C	
3	Overtone Order	-	3			
4	Load Capacitance	$C_L$	$\infty$		pF	
5	Rated Drive Level	$P_o$	0.1		mW	
6	Frequency Adjustment Tolerance	$\frac{\Delta f}{f}$	-10	+10	$10^{-6}$	At $T_o$ °C
7	Resonance Resistance	$R_r$	-	40	$\Omega$	At $T_o$ °C
8	Frequency Variation with Temperature over $T_{op}$	$\frac{\Delta f}{f}$	0 -9.0 -9.0	+9.0 +9.0 0	$10^{-6}$	From T -20 to +10 °C From T +10 to +50 °C From T +50 to +80 °C
9	Resistance Variation with Temperature over $T_{op}$	$\frac{\Delta R}{R}$	-2.0	+2.0	$\Omega$	From resistance measured at $T_o$ °C
10	Operating Temperature Range	$T_{op}$	-20	+80	°C	
11	Frequency variation with Drive Level	$\frac{\Delta f}{f}$	-0.5	+0.5	$10^{-6}$	From $P_{S1} = 0.01mW$ to $P_{S2} = 0.1mW$
12	Resistance variation with Drive Level	$\frac{\Delta R}{R}$	-20	+20	%	From $P_{S1} = 0.01mW$ to $P_{S2} = 0.1mW$
13	Motional Inductance	$L_1$	3.0	-	mH	
14	Motional Capacitance	$C_1$	Not applicable		fF	
15	Static Capacitance	$C_o$	-	5.0	pF	
16	Q Factor	Q	70 000	-	-	
17	Ratio of Unwanted: Response Resistance to Resonance Resistance or Response Impedance to Resonance Resistance	$R_p/R$ or $ Z_p /R$	3:1	-		In the frequency range: $f_r - 10\%$ to $f_r + 10\%$
18	Ageing	$\frac{\Delta f}{f}$	-3.0	+3.0	$10^{-6}$	12 years after 500 hours Burn-in
19	Terminal Length	L	Figure 2		mm	
20	Intended Application		TCXO			





**TABLE 1(a) - TYPE VARIANT DETAILED INFORMATION**

TYPE VARIANT NO. 97

No.	Characteristics	Symbol	Limits		Unit	Remarks
			Min.	Max.		
1	Resonance Frequency	$f_r$	37.083333		MHz	
2	Reference Temperature	$T_o$	+ 20	+ 30	°C	
3	Overtone Order	-	3			
4	Load Capacitance	$C_L$	$\infty$		pF	
5	Rated Drive Level	$P_o$	0.1		mW	
6	Frequency Adjustment Tolerance	$\frac{\Delta f}{f}$	- 10	+ 10	$10^{-6}$	At $T_o$ °C
7	Resonance Resistance	$R_r$	-	40	$\Omega$	At $T_o$ °C
8	Frequency Variation with Temperature over $T_{op}$	$\frac{\Delta f}{f}$	0 - 9.0 - 9.0	+ 9.0 + 9.0 0	$10^{-6}$	From T - 20 to + 10 °C From T + 10 to + 50 °C From T + 50 to + 80 °C
9	Resistance Variation with Temperature over $T_{op}$	$\frac{\Delta R}{R}$	- 2.0	+ 2.0	$\Omega$	From resistance measured at $T_o$ °C
10	Operating Temperature Range	$T_{op}$	- 20	+ 80	°C	
11	Frequency variation with Drive Level	$\frac{\Delta f}{f}$	- 0.5	+ 0.5	$10^{-6}$	From $P_{S1} = 0.01mW$ to $P_{S2} = 0.1mW$
12	Resistance variation with Drive Level	$\frac{\Delta R}{R}$	- 20	+ 20	%	From $P_{S1} = 0.01mW$ to $P_{S2} = 0.1mW$
13	Motional Inductance	$L_1$	3.0	-	mH	
14	Motional Capacitance	$C_1$	Not applicable		fF	
15	Static Capacitance	$C_o$	-	7.0	pF	
16	Q Factor	Q	70 000	-	-	
17	Ratio of Unwanted: Response Resistance to Resonance Resistance or Response Impedance to Resonance Resistance	$R_p/R$ or $ Z_p /R$	2:1	-		In the frequency range: $f_r - 10\%$ to $f_r + 10\%$
18	Ageing	$\frac{\Delta f}{f}$	- 5.0	+ 5.0	$10^{-6}$	12 years after Burn-in
19	Terminal Length	L	Figure 2		mm	
20	Intended Application		TCXO			

**TABLE 1(a) - TYPE VARIANT DETAILED INFORMATION**

TYPE VARIANT NO. 98


No.	Characteristics	Symbol	Limits		Unit	Remarks
			Min.	Max.		
1	Resonance Frequency	$f_r$	66.612423		MHz	
2	Reference Temperature	$T_o$	+20	+30	°C	
3	Overtone Order	-	3			
4	Load Capacitance	$C_L$	$\infty$		pF	
5	Rated Drive Level	$P_o$	0.1		mW	
6	Frequency Adjustment Tolerance	$\frac{\Delta f}{f}$	-10	+10	$10^{-6}$	At $T_o$ °C
7	Resonance Resistance	$R_r$	-	40	$\Omega$	At $T_o$ °C
8	Frequency Variation with Temperature over $T_{op}$	$\frac{\Delta f}{f}$	0 -9.0 -9.0	+9.0 +9.0 0	$10^{-6}$	From T -25 to +10 °C From T +10 to +50 °C From T +50 to +70 °C
9	Resistance Variation with Temperature over $T_{op}$	$\frac{\Delta R}{R}$	-20 -2.0	+20 +2.0	% $\Omega$	From resistance measured at $T_o$ °C
10	Operating Temperature Range	$T_{op}$	-25	+70	°C	
11	Frequency variation with Drive Level	$\frac{\Delta f}{f}$	Not applicable		$10^{-6}$	
12	Resistance variation with Drive Level	$\frac{\Delta R}{R}$	Not applicable		%	
13	Motional Inductance	$L_1$	6.5	-	mH	
14	Motional Capacitance	$C_1$	Not applicable		fF	
15	Static Capacitance	$C_o$	-	5.0	pF	
16	Q Factor	Q	90 000	-	-	
17	Ratio of Unwanted: Response Resistance to Resonance Resistance or Response Impedance to Resonance Resistance	$R_p/R$ or $ Z_p /R$	2:1	-		In the frequency range: $f_r - 10\%$ to $f_r + 10\%$
18	Ageing	$\frac{\Delta f}{f}$	-3.0	+3.0	$10^{-6}$	12 years after 500 hours Burn-in
19	Terminal Length	L	Figure 2		mm	
20	Intended Application		TCXO			



**TABLE 1(a) - TYPE VARIANT DETAILED INFORMATION**

**TYPE VARIANT NO. 99**

No.	Characteristics	Symbol	Limits		Unit	Remarks
			Min.	Max.		
1	Resonance Frequency	$f_r$	79.924863		MHz	
2	Reference Temperature	$T_o$	+ 60	+ 70	°C	
3	Overtone Order	-	3			
4	Load Capacitance	$C_L$	$\infty$		pF	
5	Rated Drive Level	$P_o$	0.1		mW	
6	Frequency Adjustment Tolerance	$\frac{\Delta f}{f}$	- 10	+ 10	$10^{-6}$	At $T_o$ °C
7	Resonance Resistance	$R_r$	-	40	$\Omega$	At $T_o$ °C
8	Frequency Variation with Temperature over $T_{op}$	$\frac{\Delta f}{f}$	Not applicable		$10^{-6}$	
9	Resistance Variation with Temperature over $T_{op}$	$\frac{\Delta R}{R}$	- 20	+ 20	%	From resistance measured at $T_o$ °C
			- 2.0	+ 2.0		
10	Operating Temperature Range	$T_{op}$	- 20	+ 80	°C	
11	Frequency variation with Drive Level	$\frac{\Delta f}{f}$	Not applicable		$10^{-6}$	
12	Resistance variation with Drive Level	$\frac{\Delta R}{R}$	Not applicable		%	
13	Motional Inductance	$L_1$	2.0	-	mH	
14	Motional Capacitance	$C_1$	Not applicable		fF	
15	Static Capacitance	$C_o$	-	5.0	pF	
16	Q Factor	Q	70 000	-	-	
17	Ratio of Unwanted: Response Resistance to Resonance Resistance or Response Impedance to Resonance Resistance	$R_p/R$ or $ Z_p /R$	2:1	-		In the frequency range: $f_r - 10\%$ to $f_r + 10\%$
18	Ageing	$\frac{\Delta f}{f}$	- 3.0	+ 3.0	$10^{-6}$	12 years after 500 hours Burn-in
19	Terminal Length	L	Figure 2		mm	
20	Intended Application		OCXO			

	<p>ESCC Detail Specification No. 3501/008</p>		<p>PAGE 122 ISSUE 2</p>
---	---	--	-----------------------------

**APPENDIX 'A'**

Page 1 of 1

AGREED DEVIATIONS FOR C-MAC FREQUENCY PRODUCTS (F)

ITEMS AFFECTED	DESCRIPTION OF DEVIATION
Para. 4.2.2	Para. 9.3, Shock: Shall not be performed.
Para. 4.2.3	Para. 9.11, Radiographic Inspection: Shall not be performed.