



Pages 1 to 122

**CRYSTAL UNITS IN METAL HOLDER,
BASED ON TYPE T1507,
FREQUENCY RANGE 2.5 - 50MHZ
ESCC Detail Specification No. 3501/002**

**ISSUE 3
April 2007**



Document Custodian: European Space Agency - see <https://escies.org>

	ESCC Detail Specification No. 3501/002		PAGE i ISSUE 3
---	---	--	-------------------

LEGAL DISCLAIMER AND COPYRIGHT

European Space Agency, Copyright © 2007. All rights reserved.

The European Space Agency disclaims any liability or responsibility, to any person or entity, with respect to any loss or damage caused, or alleged to be caused, directly or indirectly by the use and application of this ESCC publication.

This publication, without the prior permission of the European Space Agency and provided that it is not used for a commercial purpose, may be:

- copied in whole in any medium without alteration or modification.
- copied in part, in any medium, provided that the ESCC document identification, comprising the ESCC symbol, document number and document issue, is removed.

	<p>ESCC Detail Specification No. 3501/002</p>		<p>PAGE 2 ISSUE 3</p>
---	---	--	---------------------------

DOCUMENTATION CHANGE NOTICE

(Refer to <https://escies.org> for ESCC DCR content)

DCR No.	CHANGE DESCRIPTION
261, 290	<p>Specification upissued to incorporate technical and editorial changes per DCRs.</p> <p>For operational reasons, only the affected pages have the correct issue number . These are cover page, legal disclaimer, DCN, Table of contents and Appendix.</p>

	<p style="text-align: center;">ESCC Detail Specification No. 3501/002</p>	<p>PAGE 3 ISSUE 3</p>
---	---	---------------------------

TABLE OF CONTENTS

		<u>Page</u>
1.	<u>GENERAL</u>	5
1.1	Scope	5
1.2	Type Variants	5
1.3	Maximum Ratings	5
1.4	Physical Dimensions	5
1.5	Functional Diagram	5
2.	<u>APPLICABLE DOCUMENTS</u>	13
3.	<u>TERMS, DEFINITIONS, ABBREVIATIONS, SYMBOLS AND UNITS</u>	13
4.	<u>REQUIREMENTS</u>	13
4.1	General	13
4.2	Deviations from Generic Specification	13
4.2.1	Deviations from Special In-process Controls	13
4.2.2	Deviations from Final Production Tests	13
4.2.3	Deviations from Burn-in Tests	13
4.2.4	Deviations from Qualification Tests	13
4.2.5	Deviations from Lot Acceptance Tests	13
4.3	Mechanical Requirements	14
4.3.1	Dimension Check	14
4.3.2	Weight	14
4.3.3	Robustness of Terminations	14
4.4	Materials and Finishes	14
4.4.1	Case	14
4.4.2	Lead Material and Finish	14
4.5	Marking	14
4.5.1	General	14
4.5.2	The ESCC Component Number	15
4.5.3	Characteristics	15
4.5.4	Traceability Information	15
4.5.5	Manufacturer's Name, Symbol and Code	15
4.6	Electrical Measurements	15
4.6.1	Electrical Measurements at Reference Temperature	15
4.6.2	Electrical Measurements at High and Low Temperatures	15
4.6.3	Circuits for Electrical Measurements	15
4.7	Burn-in Tests	15
4.7.1	Parameter Drift Values	15
4.7.2	Conditions for Burn-in	15
4.7.3	Electrical Circuits for Burn-in	15
4.8	Environmental and Endurance Tests	18
4.8.1	Measurements and Inspections on Completion of Environmental Tests	18
4.8.2	Measurements and Inspections at Intermediate Points and on Completion of Endurance Tests	18
4.8.3	Conditions for Operating Life Test	18

TABLES

1(a)	Type Variant Summary	6
	Type Variant Detailed Information	22
1(b)	Maximum Ratings	8
1(c)	Format for Individual Tables 1(a)	9
2	Electrical Measurements at Reference Temperature	16
3	Electrical Measurements at High and Low Temperatures	17
4	Parameter Drift Values	17
5	Conditions for Burn-in and Life Test	17
6	Measurements and Inspections on Completion of Environmental Tests and at Intermediate Points and on Completion of Endurance Testing	19

FIGURES

1	Parameter Derating Information	N/A
2	Physical Dimensions	12
3	Functional Diagram	12
4	Circuits for Electrical Measurements	N/A
5	Electrical Circuit for Burn-in and Life Test	N/A

APPENDICES (Applicable to specific Manufacturers only)

A	C-MAC Frequency Products	122
---	--------------------------	-----

	<p style="text-align: center;">ESCC Detail Specification No. 3501/002</p>		<p>PAGE 5 ISSUE 2</p>
---	---	--	---------------------------

1. GENERAL

1.1 SCOPE

This specification details the values, physical and electrical characteristics, test and inspection data for Crystal Units in Metal Holder, based on Type T1507, Frequency Range 2.5 - 50MHz.

It shall be read in conjunction with ESCC Generic Specification No. 3501, the requirements for which are supplemented herein.

1.2 TYPE VARIANTS

A list of the type variants of the crystal units specified herein, which are also covered by this specification, is given in "Table 1(a) - Type Variant Summary".

For each type variant, the full electrical and physical characteristics are given in individual Tables 1(a) - "Type Variant Detailed Information" at the end of this specification.

The contents of the individual Tables 1(a) shall be as shown in Table 1(c) and the characteristics therein listed shall relate to the design parameters of the individual crystal units, optimised for the intended application.

The specific characteristics shall be negotiated between the Manufacturer and the Orderer. The Manufacturer shall then apply to the Executive Secretariat for a type variant number for each individual crystal unit concerned, by sending a finalised Table 1(a) which shall also be copied to the Executive.

1.3 MAXIMUM RATINGS

The maximum ratings, which shall not be exceeded at any time during use or storage, applicable to the crystal units specified herein, are as scheduled in Table 1(b).

1.4 PHYSICAL DIMENSIONS

The physical dimensions of the crystal units specified herein are shown in Figure 2.

1.5 FUNCTIONAL DIAGRAM

The functional diagram showing lead identification of the crystal units specified herein is shown in Figure 3.



TABLE 1(a) - TYPE VARIANT SUMMARY

Variant	Resonance Frequency (MHz)	Load Capacitance (C _L pF)	Reference Temp. (T ₀ °C)	Operating Temp. Range (T _{op} °C)	Lead Finish
01	3.317	19	+25	-20 to +60	2
02	2.496 & 2.5344	30	+25	-20 to +50	2
03	2.8	20	+25	-30 to +60	2
04	2.7 to 5.0	30	+25	-40 to +80	2
05	3.2768	∞	+25	-20 to +70	2
06	4.095	∞	+25	-30 to +60	2
07	5.0	30	+40	-10 to +70	2
08	5.105555	30	+25	-55 to +105	2
09	5.333 to 5.334	140	+15	-20 to +60	2
10	5.661448	22 to 33	+25	-30 to +60	2
11	8.7 to 10.7	∞	+25	-40 to +80	2
12	10.0	22	+60	-20 to +70	2
13	10.0	50	+25	-10 to +80	2
14	10.7	30	+25	-55 to +105	2
15	11.0	30	+25	-55 to +105	2
16	11.433333	20	+25	-20 to +80	2
17	12.8	30	+25	-55 to +105	2
18	14.7456	∞	+25	-20 to +70	2
19	12.0	∞	+25	-20 to +70	2
20	12.288	20 to 50	+60	-30 to +70	2
21	15.0	25	+25	-30 to +80	2
22	4.096	50	+25	-20 to +80	2
22	4.096	50	+25	-20 to +80	3 or 4
23	19.109567	∞	+25	-30 to +60	2
24	6.4	∞	+25	-20 to +60	2
25	7.0	∞	+25	-20 to +60	2
26	12.0	30	+25	-20 to +60	2
27	15.0	20 to 50	+25	-20 to +70	2
28	6.4	30	+25	-20 to +60	2
29	7.0	30	+25	-20 to +60	2
30	12.0	50	+40	-20 to +80	2
31	4.608	30	+25	-35 to +70	2
32	10.0	50	+40	-20 to +80	2
33	13.3	30	+25	-35 to +70	2
34	3.2768	27 to 33	+27	-20 to +50	2
35	8.0	30	+27	-20 to +50	2
36	6.0	16	+25	-20 to +70	2
37	4.608	27 to 33	+25	-25 to +70	2
38	4.608	30	+25	-40 to +70	2
39	5.0	27	+25	-40 to +70	2
40	3.2768	20 to 50	+25	-20 to +70	2

TABLE 1(a) - TYPE VARIANT SUMMARY (CONTINUED)

Variant	Resonance Frequency (MHz)	Load Capacitance (C _L pF)	Reference Temp. (T ₀ °C)	Operating Temp. Range (T _{op} °C)	Lead Finish
41	4.096	50	+25	-10 to +80	2
42	5.0	30	+40	-20 to +80	2
43	5.0	30	+40	-10 to +70	2
44	10.0	50	+25	-10 to +80	2
45	12.0	∞	+25	-20 to +70	2
46	12.0	∞	+25	-40 to +85	2
47	13.332	50	+40	-20 to +80	2
48	5.24288	22	+60	-40 to +85	2
49	3.2	30	+27	-20 to +70	2
50	4.0	30	+25	-40 to +80	2
51	4.194304	30	+30	-10 to +80	2
52	12.25	32	+25	-20 to +70	2
53	6.0	30	+25	-40 to +70	2
54	9.66 to 10.65	50	+25	-20 to +70	2
55	4.096	50	+25	-10 to +80	2
56	4.194304	22	+60	-20 to +70	2
57	5.24288	22	+60	-20 to +70	2
58	8.0	22	+60	-20 to +70	2
59	13.332	50	+40	-20 to +80	2
60	4.194304	30	+25	-30 to +70	2
61	12.25	32	+25	-20 to +70	2
62	4.096	∞	+25	-30 to +80	2
63	4.194304	∞	+25	-30 to +80	2
64	5.24288	22	+25	-20 to +70	2
65	12.25	32	+25	-20 to +70	2
66	5.0	20 to 40	+25	-10 to +40	2
67	5.0	30	+27	-20 to +70	2
68	12.0	30	+27	-20 to +70	2
69	11.0	∞	+25	-20 to +80	2
70	12.0	32	+25	-25 to +90	2
71	4.9152	30	+25	-20 to +60	2
72	15.0	30	+25	-40 to +85	2
73	7.5	30	+25	-20 to +50	2
74	8.194442	30	+25	-20 to +50	2
75	10.0	30	+25	-40 to +70	2
76	4.0	50	+25	-55 to +125	2
77	8.388	30	+25	-10 to +50	2
78	4.194304	30	+25	-30 to +70	2
79	3.2768	30	+25	-30 to +70	2
80	16.0	30	+25	-30 to +70	2

TABLE 1(a) - TYPE VARIANT SUMMARY (CONTINUED)

Variant	Resonance Frequency (MHz)	Load Capacitance (C _L pF)	Reference Temp. (T ₀ °C)	Operating Temp. Range (T _{op} °C)	Lead Finish
81	15.0	30	+25	-30 to +70	2
82	4.096	∞	+25	-30 to +80	2
83	10.0	30	+25	-55 to +100	2
84	18.0	30	+25	-10 to +70	2
85	25.0	∞	+25	-25 to +75	2
86	3.6864	∞	+25	-25 to +80	2
87	5.24288	22	+60	-20 to +70	2
88	12.0	30	+25	-10 to +80	2
89	3.6864	30	+25	-10 to +80	2
90	12.136285	∞	+25	-30 to +65	2
91	18.0	50	+40	-20 to +80	2
92	8.388608	∞	+25	-40 to +75	2
93	10.0	30	+40	-20 to +90	2
94	6.0	30	+25	-45 to +75	2
95	12.5	30	+25	-40 to +85	2
96	11.059	50	+25	-35 to +70	2
97	7.3728	30	+25	-30 to +80	2
98	5.12	30	+40	-40 to +80	2
99	10.0	18 to 30	+72	-25 to +80	2

NOTES

- Full electrical and physical characteristics are given in the individual Tables 1(a) at the end of this specification.

TABLE 1(b) - MAXIMUM RATINGS

No.	Characteristic	Symbol	Values	Unit	Remarks
1	Nominal Frequency Range	f	2.5 to 20	MHz	Note 1
2	Drive Level Range	P	0.01 to 0.2	mW	
3	Operating Temperature Range	T _{op}	-	°C	Note 2
4	Storage Temperature Range	T _{stg}	-65 to +125	°C	Note 3
5	Soldering Temperature	T _{sol}	+260	°C	Note 4

NOTES

- | Fundamental and Overtone Order | Approx. Frequency Range (MHz) |
|--------------------------------|-------------------------------|
| Fundamental | 2.5 to 20 |
| 3 | 10 to 30 |
| 5 | 15 to 50 |

- See Table 1(a).
- The duration at maximum storage temperature shall not exceed 16 hours.
- Duration 10 seconds maximum at a distance of not less than 3.0mm from the device body and the same lead shall not be resoldered until 3 minutes have elapsed.



TABLE 1(c) - FORMAT FOR INDIVIDUAL TABLES 1(a)

TABLE 1(a) - TYPE VARIANT DETAILED INFORMATION
TYPE VARIANT NO.

No.	Characteristic	Symbol	Limits		Unit	Remarks
			Min.	Max		
1	Resonance Frequency	f_r or f_L			MHz	Note 1
2	Reference Temperature	T_0			°C	Note 2
3	Overtone Order	-				
4	Load Capacitance	C_L			pF	Note 3
5	Rated Drive Level	P_0			mW	Note 4
6	Frequency Adjustment Tolerance	$\frac{\Delta f}{f}$			10 ⁻⁶	At T_0 °C Note 5
7	Resonance Resistance	R_r or R_L			Ω	At T_0 °C Note 6
8	Frequency Variation with Temperature over T_{op}	$\frac{\Delta f}{f}$			10 ⁻⁹	From frequency measured at T_0 °C Note 7
9	Resistance Variation with Temperature over T_{op}	$\frac{\Delta R}{R}$			%	From resistance measured at T_0 °C Note 7
10	Operating Temperature Range	T_{op}			°C	
11	Frequency variation with Drive Level	$\frac{\Delta f}{f}$			10 ⁻⁶	From $P_{S1} =$ mW to $P_{S2} =$ mW Note 8
12	Resistance variation with Drive Level	$\frac{\Delta R}{R}$			%	From $P_{S1} =$ mW to $P_{S2} =$ mW Note 8
13	Motional Inductance	L_1			mH	Notes 9 and 10
14	Motional Capacitance	C_1			fF	Note 9
15	Static Capacitance	C_0			pF	Note 9
16	Q Factor	Q			-	Notes 9 and 11
17	Ratio of unwanted: Response Resistance to Resonance Resistance or Response Impedance to Resonance Resistance	R_p/R or $ Z_p /R$				In the frequency range: f - kHz to f + kHz
18	Ageing	$\frac{\Delta f}{f}$			10 ⁻⁶	Note 13
19	Lead Finish	-			-	
20	Intended Application					Note 15

NOTES: See Pages 10 and 11.



NOTES TO TABLE 1(c)

1. (a) If C_L is not specified, Symbol and measurement shall be f_r .
(b) If C_L is specified, Symbol and measurement shall be f_L .
2. Reference Temperature T_0
 - (a) For a crystal unit functioning in a non-controlled temperature environment, the reference temperature is normally $+25 \pm 2$ °C.
 - (b) For a crystal unit functioning in a controlled temperature environment, the reference temperature shall normally be the mid-point of the temperature range of the controlled environment.
3. Load Capacitance C_L
 - (a) When a crystal unit must function at its series resonance frequency, C_L shall be infinite.
 - (b) When a crystal must function with a load capacitance, the C_L value shall be specified. The standard values of load capacitance are as follows:
 - Fundamental Frequency Operation: 20pF, 30pF, 50pF and 100pF.
 - Overtone Operation: 8pF, 12pF, 15pF, 20pF and 30pF.

N.B

The tolerance on the load capacitance shall be that value which results in a frequency change not exceeding 10% of the frequency tolerance at T_0 or 1% of the nominal load capacitance, whichever is smaller.

4. Rated Drive Level P_0

The rated drive level shall be selected from the standard drive levels specified below:

 - Preferred values: 2mW, 1mW, 0.5mW, 0.2mW, 0.1mW, 0.05mW, 0.02mW, 0.01mW, 0.001mW or 0.0001mW at $\pm 20\%$.
 - Non-preferred values: 10mW, 5mW and 4mW all at $\pm 20\%$.
5. Frequency Adjustment Tolerance
 - (a) When a crystal must function at its series resonance frequency, the standard value of the adjustment tolerance shall be $\pm 10 \times 10^{-6}$.
 - (b) When a crystal has to function with a load capacitance, the standard value of the adjustment tolerance shall also be $\pm 10 \times 10^{-6}$. However, if the load capacitance is adjustable, it is preferable to specify that the nominal frequency be obtained with a load capacitance value between the minimum and maximum value when the crystal is functioning in its fundamental mode.
6. Resonance Resistance
 - (a) Generally, the maximum value only is specified.
 - (b) R_L may be calculated by $R_L = R_r \left(1 + \frac{C_0}{C_L} \right)^2$

	<p style="text-align: center;">ESCC Detail Specification No. 3501/002</p>		<p style="text-align: right;">PAGE 11 ISSUE 2</p>
---	---	--	---

NOTES TO TABLE 1(c) (Continued)

7. Frequency and Resistance Variation with Temperature

These values shall be specified such that they are consistent with the operating temperature range.

8. Frequency and Resistance Variation with Drive Level

These limits and the Drive Level range (PS1 to PS2) shall be specified for very special crystals only (i.e. crystals used in very high stability oscillators).

9. Electrical Values

The electrical values shall be specified only when required for the correct functioning of the equipment in which the crystal is used.

10. Motional Inductance L_1

Because the inductance value may be restricted by other chosen parameters, the Manufacturer shall propose the value of L_1 in accordance with the Customer's requirements.

11. 'Q' Factor

If 'R' and 'L' have been already specified, it will not be necessary to specify the minimum value of the 'Q' factor.

The maximum value of the 'Q' factor is never specified.

12. Ratio of Unwanted Response Resistance to Resonance Resistance

The standard minimum value is 2, but it is possible to obtain higher values.

The frequency range within which the minimum value of the ratio is required shall also be specified.

13. Ageing

Specify limits under appropriate column and ageing period under "Remarks".

14. Not applicable Items

For all items where limits are not specified, "Not applicable" shall be entered in the Limits column.

15. Intended Application

For definitions of the selected symbol to be added, see ESCC Generic Specification No. 3501, Para. 3.

FIGURE 1 - PARAMETER DERATING INFORMATION

Not applicable.

FIGURE 2 - PHYSICAL DIMENSIONS

SYMBOL	MILLIMETRES		REMARKS
	MIN.	MAX.	
∅A	-	15.75	
C	-	6.80	
H	6.90	7.40	Pitch 7.16mm
∅K	0.40	0.48	
L	12.70	-	
P	-	0.90	Note 2
Q	-	0.95	Note 2

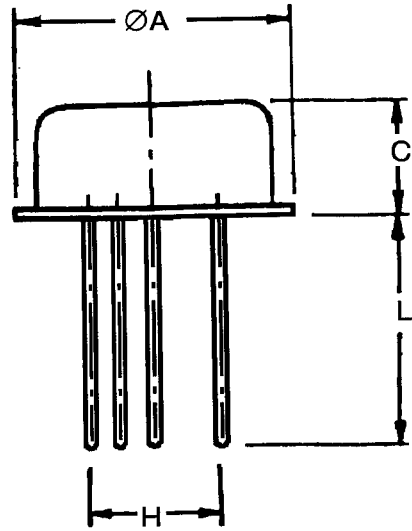

NOTES

1. Lead No. 5 is grounded to case.
2. The tag's position or presence is optional.

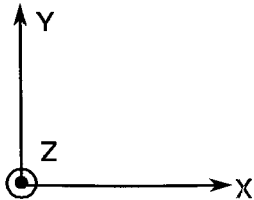
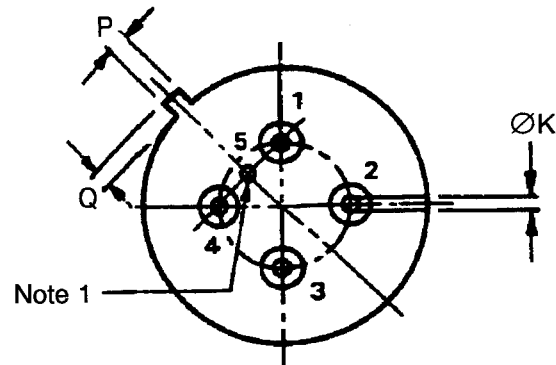
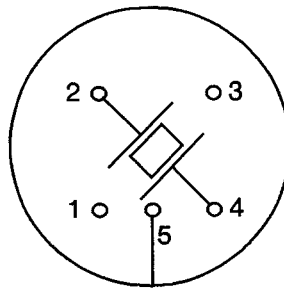

FIGURE 3 - FUNCTIONAL DIAGRAM



(BOTTOM VIEW)

2. APPLICABLE DOCUMENTS

The following documents form part of this specification and shall be read in conjunction with it:-

- (a) ESCC Generic Specification No. 3501 for Quartz Crystal Units.

3. TERMS, DEFINITIONS, ABBREVIATIONS, SYMBOLS AND UNITS

For the purpose of this specification, the terms, definitions, abbreviations, symbols and units specified in ESCC Basic Specification No. 21300 shall apply. In addition, the following symbols are used:-

Resonance Frequency	= f_r
Load Resonance Frequency	= f_L
Reference Temperature	= T_o
Resonance Resistance	= R_r
Load Resonance Resistance	= R_L
Rated Drive Level	= P_o
Static Capacitance	= C_o
Load Capacitance	= C_L
Motional Capacitance	= C_1
Motional Inductance	= L_1
Response Resistance	= R_p
Response Impedance	= $ Z_p $
Insulation Resistance	= R_i

4. REQUIREMENTS

4.1 GENERAL

The complete requirements for procurement of the crystal units specified herein shall be as stated in this specification and ESCC Generic Specification No. 3501 for Quartz Crystal Units. Deviations from the Generic Specification applicable to this specification only, are detailed in Para. 4.2.

Deviations from the applicable Generic Specification and this Detail Specification, formally agreed with specific Manufacturers on the basis that the alternative requirements are equivalent to the ESCC requirements and do not affect the components' reliability, are listed in the appendices attached to this specification.

4.2 DEVIATIONS FROM GENERIC SPECIFICATION

4.2.1 Deviations from Special In-process Controls

None.

4.2.2 Deviations from Final Production Tests (Chart II)

None.

4.2.3 Deviations from Burn-in Tests (Chart III)

None.

4.2.4 Deviations from Qualification Tests (Chart IV)

None.

4.2.5 Deviations from Lot Acceptance Tests (Chart V)

None.

	<p style="text-align: center;">ESCC Detail Specification No. 3501/002</p>		<p>PAGE 14 ISSUE 2</p>
--	---	--	----------------------------

4.3 MECHANICAL REQUIREMENTS

4.3.1 Dimension Check

The dimensions of the crystal units specified herein shall be checked. They shall conform to those shown in Figure 2.

4.3.2 Weight

The maximum weight of the crystal units specified herein shall be 3.0 grammes.

4.3.3 Robustness of Terminations

The requirements for robustness of termination testing are specified in Section 9 of ESCC Generic Specification No. 3501.

4.4 MATERIALS AND FINISHES

The materials and finishes shall be as specified herein. Where a definite material is not specified, a material which will enable the crystal units specified herein to meet the performance requirements of this specification shall be used. Acceptance or approval of any constituent material does not guarantee acceptance of the finished product.

4.4.1 Case

4.4.1.1 Cap

Copper, nickel plated or nickel and gold plated.

4.4.1.2 Base

Kovar, nickel plated or nickel and gold plated.

4.4.2 Lead Material and Finish

The lead material shall be Type 'D' with either Type '2' or Type '3 or 4 ' finish in accordance with the requirements of ESCC Basic Specification No. 23500. (See Tables 1(a) for Type Variants).

4.5 MARKING

4.5.1 General

The marking of all components delivered to this specification shall be in accordance with the requirements of ESCC Basic Specification No. 21700 and the following paragraphs. When the component is too small to accommodate all of the marking specified, as much as space permits shall be marked and the marking information, in full, shall accompany the component in its primary package.

The information to be marked and the order of precedence, shall be as follows:-

- (a) The ESCC Component Number.
- (b) Characteristics.
- (c) Traceability Information.

4.5.2 The ESCC Component Number

Each component shall bear the ESCC Component Number, which shall be constituted and marked as follows:-

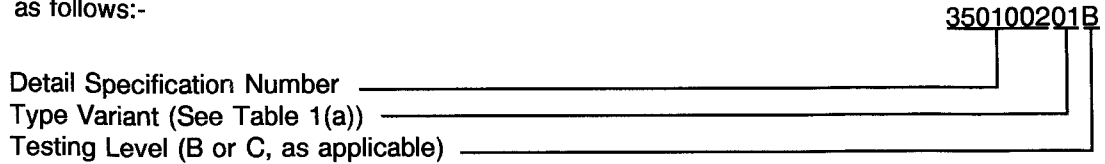

4.5.3 Characteristics

The resonance frequency of the crystal units shall be clearly specified in MHz. Where necessary, it shall be specified to 6 decimal places.

4.5.4 Traceability Information

Each component shall be marked in respect of traceability information in accordance with the requirements of ESCC Basic Specification No. 21700.

4.5.5 Manufacturer's Name, Symbol or Code

The Manufacturer's marking shall be in accordance with the requirements of ESCC Basic Specification No. 21700.

4.6 ELECTRICAL MEASUREMENTS

4.6.1 Electrical Measurements at Reference Temperature

The parameters to be measured in respect of electrical characteristics are scheduled in Table 2. The measurements shall be performed at the temperatures specified in the individual Tables 1(a), Item 2.

4.6.2 Electrical Measurements at High and Low Temperatures

The parameters to be measured at high and low temperatures are scheduled in Table 3. These measurements shall only be performed if values are specified in Table 1(a) Items 8 and/or 9.

4.6.3 Circuits for Electrical Measurements (Figure 4)

Not applicable.

4.7 BURN-IN TESTS

4.7.1 Parameter Drift Values

The parameter drift values applicable to burn-in are specified in Table 4 of this specification. Unless otherwise stated, measurements shall be performed at $T_{amb} = T_o \pm 2 \text{ }^\circ\text{C}$. The parameter drift values (Δ) applicable to the scheduled parameters shall not be exceeded. In addition to these drift value requirements for a given parameter, the appropriate limit value specified in Table 2 shall not be exceeded.

4.7.2 Conditions for Burn-in

The requirements for burn-in are specified in Section 7 of ESCC Generic Specification No. 3501. The conditions for burn-in shall be as specified in Table 5 of this specification.

4.7.3 Electrical Circuits for Burn-in (Figure 5)

Not applicable.

TABLE 2 - ELECTRICAL MEASUREMENTS AT REFERENCE TEMPERATURE

No.	Characteristics	Symbol	ESCC 3501 Test Method	Limits	Unit
1	Resonance frequency at reference temperature and rated drive level - with C_O - with C_L	$f_r (T_o, P_o)$ $f_L (T_o, P_o)$	Para. 9.2.1.1	Table 1(a), Item 1 \pm Item 6	MHz
2	Resonance resistance at reference temperature and rated drive level - with C_O - with C_L	$R_r (T_o, P_o)$ $R_L (T_o, P_o)$	Para. 9.2.1.1	Table 1(a), Item 7	Ω
3	Frequency variation with Drive Level	$\frac{\Delta f}{f} (T_o, \Delta P)$	Para. 9.2.1.1	Table 1(a), Item 11	10^{-6}
4	Resistance variation with Drive Level	$\frac{\Delta R}{R} (T_o, \Delta P)$	Para. 9.2.1.1	Table 1(a), Item 12	%
5	Motional Inductance	L_1	Para. 9.2.1.3	Table 1(a), Item 13	mH
6	Static Capacitance	C_o	Para. 9.2.1.4	Table 1(a), Item 15	pF
7	Unwanted response	R_p/R or $ Z_p /R$	Para. 9.2.1.5	Table 1(a), Item 17	-
8	Insulation Resistance	R_i	Para. 9.2.1.6	500 Min.	$M\Omega$

TABLE 3 - ELECTRICAL MEASUREMENTS AT HIGH AND LOW TEMPERATURES

No.	Characteristics	Symbol	ESCC 3501 Test Method	Limits	Unit
9	Frequency variation with Temperature over T _{op}	$\frac{\Delta f}{f} (\Delta T, P_o)$	Para. 9.2.1.2	Table 1(a) Item 8	10 ⁻⁶
10	Resistance variation with Temperature over T _{op}	$\frac{\Delta R}{R} (\Delta T, P_o)$	Para. 9.2.1.2	Table 1(a) Item 9	%

FIGURE 4 - CIRCUITS FOR ELECTRICAL MEASUREMENTS

Not applicable.

TABLE 4 - PARAMETER DRIFT VALUES

No.	Characteristics	Symbol	Spec. and/or Test Method	Test Conditions	Change Limits (Δ)	Unit
1	Resonance frequency drift	$\frac{\Delta f}{f}$	As per Table 2	As per Table 2	± 2.0	10 ⁻⁶
2	Resonance resistance drift	$\frac{\Delta R}{R}$	As per Table 2	As per Table 2	± 10 or (1) ± 1.0	% Ω

NOTES 1. Whichever is the highest value.

TABLE 5 - CONDITIONS FOR BURN-IN AND LIFE TEST

No.	Characteristics	Symbol	Condition	Unit
1	Ambient Temperature	T _{amb}	+85 \pm 5	°C

FIGURE 5 - ELECTRICAL CIRCUIT FOR BURN-IN AND LIFE TEST

Not applicable.

4.8 ENVIRONMENTAL AND ENDURANCE TESTS (CHARTS IV AND V OF ESCC GENERIC SPECIFICATION NO. 3501)

4.8.1 Measurements and Inspections on Completion of Environmental Tests

The parameters to be measured and inspections to be performed on completion of environmental tests are scheduled in Table 6. Unless otherwise stated, the measurements shall be performed at $T_{amb} = T_o \pm 2 \text{ }^\circ\text{C}$.

4.8.2 Measurements and Inspections at Intermediate Points and on Completion of Endurance Tests

The parameters to be measured and inspections to be performed at intermediate points and on completion of endurance tests are scheduled in Table 6. Unless otherwise stated, the measurements shall be performed at $T_{amb} = T_o \pm 2 \text{ }^\circ\text{C}$.

4.8.3 Conditions for Operating Life Test (Part of Endurance Testing)

The requirements for the operating life test are specified in Section 9 of ESCC Generic Specification No. 3501. The test shall be performed as a high temperature storage test and the temperature to be applied shall be the maximum operating temperature specified in the individual Tables 1(a) given in this specification.

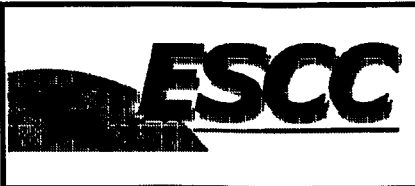

TABLE 6 - MEASUREMENTS AND INSPECTIONS ON COMPLETION OF ENVIRONMENTAL TESTS AND AT INTERMEDIATE POINTS AND ON COMPLETION OF ENDURANCE TESTING

NO.	ESCC GENERIC SPEC. NO. 3501		MEASUREMENTS AND INSPECTIONS		SYMBOL	LIMITS		UNIT
	ENVIRONMENTAL AND ENDURANCE TESTS (1)	TEST METHOD AND CONDITIONS	IDENTIFICATION	CONDITIONS		Min.	Max.	
01	Electrical Measurements at Reference Temperature	Para. 9.2.4	Electrical Measurements	Table 2		Table 1(a)		
02	Shock	Para. 9.3	Initial Measurements Resonance Frequency Resonance Resistance Final Measurements Resonance Frequency Drift Resonance Resistance Drift	Table 2 Item 1 Table 2 Item 2 Table 2 Item 1 Table 2 Item 2	f R $\frac{\Delta f}{f}$ $\frac{\Delta R}{R}$ ΔR	Table 2 Item 1 Table 2 Item 2 - 1.0 - 10 or (2) - 1.0	+ 1.0 + 1.0 + 10 + 1.0	10 ⁻⁶ % Ω
03	Vibration	Para. 9.4	Initial Measurements Resonance Frequency Resonance Resistance Final Measurements Resonance Frequency Drift Resonance Resistance Drift	Table 2 Item 1 Table 2 Item 2 Table 2 Item 1 Table 2 Item 2	f R $\frac{\Delta f}{f}$ $\frac{\Delta R}{R}$ ΔR	Table 2 Item 1 Table 2 Item 2 - 1.0 - 10 or (2) - 1.0	+ 1.0 + 1.0 + 10 + 1.0	10 ⁻⁶ % Ω
04	Seal Test	Para. 9.5	Fine Leak Gross Leak	Para. 9.5.1 Para. 9.5.2		Para. 9.5.1 Para. 9.5.2		
05	Permanence of Marking	Para. 9.8	Final Measurements Visual Examination	No corrosion or obliteration of marking	-	-	-	-
06	External Visual Inspection	Para. 9.9	Final Measurements Visual Inspection	ESCC No. 20500	-	-	-	-
07	Solderability	Para. 9.13	-	-	-	-	-	-

NOTES

1. The tests in this table refer to either Chart IV or V, and shall be used as applicable.
2. Whichever is the highest value.

TABLE 6 - MEASUREMENTS AND INSPECTIONS ON COMPLETION OF ENVIRONMENTAL TESTS AND AT INTERMEDIATE POINTS AND ON COMPLETION OF ENDURANCE TESTING (Cont.)

NO.	ESCC GENERIC SPEC. NO. 3501		MEASUREMENTS AND INSPECTIONS		SYMBOL	LIMITS		UNIT
	ENVIRONMENTAL AND ENDURANCE TESTS (1)	TEST METHOD AND CONDITIONS	IDENTIFICATION	CONDITIONS		Min.	Max.	
08	Climatic Sequence Dry Heat	Para. 9.14 Para. 9.14.1	Initial Measurements					
			Resonance Frequency	Table 2 Item 1	f	Table 2 Item 1		
			Resonance Resistance	Table 2 Item 2	R	Table 2 Item 2		
			Final Measurements					
09	Cold	Para. 9.14.3	Resonance Frequency	Table 2 Item 1	$\frac{\Delta f}{f}$	-2.0	+2.0	10 ⁻⁶
			Drift					
			Resonance Resistance	Table 2 Item 2	$\frac{\Delta R}{R}$	-10	+10	%
			Drift		ΔR	or (2) -1.0	+1.0	Ω
10	Damp Heat (Accelerated) Remaining Cycles	Para. 9.14.4	Initial Measurements					
			Resonance Frequency	Table 2 Item 1	f	Para. 9.14.1.3		
			Resonance Resistance	Table 2 Item 2	R	Final Measurements		
			Final Measurements					
10	Damp Heat (Accelerated) Remaining Cycles	Para. 9.14.4	Resonance Frequency	Table 2 Item 1	$\frac{\Delta f}{f}$	-2.0	+2.0	10 ⁻⁶
			Drift					
			Resonance Resistance	Table 2 Item 2	$\frac{\Delta R}{R}$	-10	+10	%
			Drift		ΔR	or (2) -1.0	+1.0	Ω
11	Rapid Change of Temperature	Para. 9.15	Initial Measurements					
			Resonance Frequency	Table 2 Item 1	f	Para. 9.14.4.2		
			Resonance Resistance	Table 2 Item 2	R	Final Measurements		
			Final Measurements					
11	Rapid Change of Temperature	Para. 9.15	Resonance Frequency	Table 2 Item 1	$\frac{\Delta f}{f}$	-2.0	+2.0	10 ⁻⁶
			Drift					
			Resonance Resistance	Table 2 Item 2	$\frac{\Delta R}{R}$	-10	+10	%
			Drift		ΔR	or (2) -1.0	+1.0	Ω
12	Robustness of Terminations	Para. 9.16	Tensile Strength	Gen. 3501 Para. 9.16.1				
			Visual Examination	No visible damage				
			Bending	Gen. 3501 Para. 9.16.2				
			Visual Examination	No visible damage				

NOTES

1. The tests in this table refer to either Chart IV or V, and shall be used as applicable.
2. Whichever is the highest value.

TABLE 6 - MEASUREMENTS AND INSPECTIONS ON COMPLETION OF ENVIRONMENTAL TESTS AND AT INTERMEDIATE POINTS AND ON COMPLETION OF ENDURANCE TESTING (Cont.)

NO.	ESA/SCC GENERIC SPEC. NO. 3501		MEASUREMENTS AND INSPECTIONS		SYMBOL	LIMITS		UNIT	
	ENVIRONMENTAL AND ENDURANCE TESTS (1)	TEST METHOD AND CONDITIONS	IDENTIFICATION	CONDITIONS		Min.	Max.		
13	Life Test	Para. 9.17	Initial Measurements						
			Resonance Frequency	Table 2 Item 1	f	Table 2 Item 1			
			Resonance Resistance	Table 2 Item 2	R	Table 2 Item 2			
			Intermediate Measurements	At 500 hours					
			Resonance Frequency	Table 2 Item 1	$\frac{\Delta f}{f}$		-2.0	+2.0	10 ⁻⁶
			Drift						
			Resonance Resistance	Table 2 Item 2	$\frac{\Delta R}{R}$		-10	+10	%
			Drift				or (2)		
							-1.0	+1.0	Ω
			Intermediate Measurements (Chart IV) and Final Measurements (Chart V)	At 1000 hours					
			Resonance Frequency	Table 2 Item 1	$\frac{\Delta f}{f}$		-2.5	+2.5	10 ⁻⁶
			Drift						
			Resonance Resistance	Table 2 Item 2	$\frac{\Delta R}{R}$		-10	+10	%
Drift				or (2)					
				-1.0	+1.0	Ω			
Final Measurements (Chart IV)	At 2000 hours								
Resonance Frequency	Table 2 Item 1	$\frac{\Delta f}{f}$		-3.0	+3.0	10 ⁻⁶			
Drift									
Resonance Resistance	Table 2 Item 2	$\frac{\Delta R}{R}$		-10	+10	%			
Drift				or (2)					
				-1.0	+1.0	Ω			

NOTES

1. The tests in this table refer to either Chart IV or V, and shall be used as applicable.
2. Whichever is the highest value.

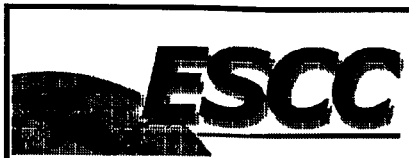

TABLE 1(a) - TYPE VARIANT DETAILED INFORMATION

TYPE VARIANT NO. 01

No.	Characteristics	Symbol	Limits		Unit	Remarks
			Min.	Max.		
1	Resonance Frequency	f_L	3.317		MHz	
2	Reference Temperature	T_o	+ 25		°C	
3	Overtone Order	-	Fundamental			
4	Load Capacitance	C_L	-	19	pF	
5	Rated Drive Level	P_o	0.1		mW	
6	Frequency Adjustment Tolerance	$\frac{\Delta f}{f}$	-1000	+ 1000	10^{-6}	At T_o °C
7	Resonance Resistance	R_L	-	50	Ω	Over T_{op} °C
8	Frequency Variation with Temperature over T_{op}	$\frac{\Delta f}{f}$	-1000	+ 1000	10^{-6}	From frequency measured at T_o °C
9	Resistance Variation with Temperature over T_{op}	$\frac{\Delta R}{R}$	Not applicable		%	
10	Operating Temperature Range	T_{op}	-20	+ 60	°C	
11	Frequency variation with Drive Level	$\frac{\Delta f}{f}$	-1000	+ 1000	10^{-6}	From $P_{S1} = 0.05mW$ to $P_{S2} = 0.2mW$
12	Resistance variation with Drive Level	$\frac{\Delta R}{R}$	Not applicable		%	
13	Motional Inductance	L_1	Not applicable		mH	
14	Motional Capacitance	C_1	Not applicable		fF	
15	Static Capacitance	C_o	Not applicable		pF	
16	Q Factor	Q	Not applicable		-	
17	Ratio of Unwanted: Response Resistance to Resonance Resistance or Response Impedance to Resonance Resistance	R_p/R or $ Z_p /R$	Not applicable			
18	Ageing	$\frac{\Delta f}{f}$	Not applicable		10^{-6}	
19	Lead Finish	-	2		-	



TABLE 1(a) - TYPE VARIANT DETAILED INFORMATION

TYPE VARIANT NO. 02

No.	Characteristics	Symbol	Limits		Unit	Remarks
			Min.	Max.		
1	Resonance Frequency	f_L	2.496 & 2.5344		MHz	
2	Reference Temperature	T_0	+ 25		°C	
3	Overtone Order	-	Fundamental			
4	Load Capacitance	C_L	30		pF	
5	Rated Drive Level	P_0	0.1		mW	
6	Frequency Adjustment Tolerance	$\frac{\Delta f}{f}$	-15	+ 15	10^{-6}	At T_0 °C
7	Resonance Resistance	R_L	-	130	Ω	Over T_{op} °C
8	Frequency Variation with Temperature over T_{op}	$\frac{\Delta f}{f}$	-20	+ 20	10^{-6}	From frequency measured at T_0 °C
9	Resistance Variation with Temperature over T_{op}	$\frac{\Delta R}{R}$	Not applicable		%	
10	Operating Temperature Range	T_{op}	-20	+ 50	°C	
11	Frequency variation with Drive Level	$\frac{\Delta f}{f}$	Not applicable		10^{-6}	
12	Resistance variation with Drive Level	$\frac{\Delta R}{R}$	Not applicable		%	
13	Motional Inductance	L_1	Not applicable		mH	
14	Motional Capacitance	C_1	Not applicable		fF	
15	Static Capacitance	C_0	-	3.5	pF	
16	Q Factor	Q	80 000	-	-	
17	Ratio of Unwanted: Response Resistance to Resonance Resistance or Response Impedance to Resonance Resistance	R_p/R or $ Z_p /R$	2:1	-		In the frequency range: $f_L - 200\text{kHz}$ to $f_L + 200\text{kHz}$
18	Ageing	$\frac{\Delta f}{f}$	-5.0	+ 5.0	10^{-6}	After burn-in and per year
19	Lead Finish	-	2		-	



TABLE 1(a) - TYPE VARIANT DETAILED INFORMATION

TYPE VARIANT NO. 03

No.	Characteristics	Symbol	Limits		Unit	Remarks
			Min.	Max.		
1	Resonance Frequency	f_L	2.8		MHz	
2	Reference Temperature	T_o	+ 25		°C	
3	Overtone Order	-	Fundamental			
4	Load Capacitance	C_L	20		pF	
5	Rated Drive Level	P_o	0.1		mW	
6	Frequency Adjustment Tolerance	$\frac{\Delta f}{f}$	-20	+ 20	10^{-6}	At T_o °C
7	Resonance Resistance	R_L	-	50	Ω	Over T_{op} °C
8	Frequency Variation with Temperature over T_{op}	$\frac{\Delta f}{f}$	-20	+ 20	10^{-6}	From frequency measured at T_o °C
9	Resistance Variation with Temperature over T_{op}	$\frac{\Delta R}{R}$	Not applicable		%	
10	Operating Temperature Range	T_{op}	-30	+ 60	°C	
11	Frequency variation with Drive Level	$\frac{\Delta f}{f}$	Not applicable		10^{-6}	
12	Resistance variation with Drive Level	$\frac{\Delta R}{R}$	Not applicable		%	
13	Motional Inductance	L_1	Not applicable		mH	
14	Motional Capacitance	C_1	Not applicable		fF	
15	Static Capacitance	C_o	-	5.0	pF	
16	Q Factor	Q	50 000	-	-	
17	Ratio of Unwanted: Response Resistance to Resonance Resistance or Response Impedance to Resonance Resistance	R_p/R $ Z_p /R$	3:1	-		In the frequency range: f_L -200kHz to f_L + 200kHz
18	Ageing	$\frac{\Delta f}{f}$	-5.0	+ 5.0	10^{-6}	After burn-in and per year
19	Lead Finish	-	2		-	

TABLE 1(a) - TYPE VARIANT DETAILED INFORMATION

TYPE VARIANT NO. 04

No.	Characteristics	Symbol	Limits		Unit	Remarks
			Min.	Max.		
1	Resonance Frequency	f_L	2.7 to 5.0		MHz	
2	Reference Temperature	T_o	+25		°C	
3	Overtone Order	-	Fundamental			
4	Load Capacitance	C_L	30		pF	
5	Rated Drive Level	P_o	0.1		mW	
6	Frequency Adjustment Tolerance	$\frac{\Delta f}{f}$	-10	+10	10^{-6}	At T_o °C
7	Resonance Resistance	R_L	-	100	Ω	Over T_{op} °C
8	Frequency Variation with Temperature over T_{op}	$\frac{\Delta f}{f}$	-40	+40	10^{-6}	From frequency measured at T_o °C
9	Resistance Variation with Temperature over T_{op}	$\frac{\Delta R}{R}$	Not applicable		%	
10	Operating Temperature Range	T_{op}	-40	+80	°C	
11	Frequency variation with Drive Level	$\frac{\Delta f}{f}$	Not applicable		10^{-6}	
12	Resistance variation with Drive Level	$\frac{\Delta R}{R}$	Not applicable		%	
13	Motional Inductance	L_1	Not applicable		mH	
14	Motional Capacitance	C_1	Not applicable		fF	
15	Static Capacitance	C_o	Not applicable		pF	
16	Q Factor	Q	Not applicable		-	
17	Ratio of Unwanted: Response Resistance to Resonance Resistance or Response Impedance to Resonance Resistance	R_p/R $ Z_p /R$	4:1	-		In the frequency range: $f_L -10\%$ to $f_L +10\%$
18	Ageing	$\frac{\Delta f}{f}$	Not applicable		10^{-6}	
19	Lead Finish	-	2		-	

TABLE 1(a) - TYPE VARIANT DETAILED INFORMATION

TYPE VARIANT NO. 05

No.	Characteristics	Symbol	Limits		Unit	Remarks
			Min.	Max.		
1	Resonance Frequency	f_r	3.2768		MHz	
2	Reference Temperature	T_0	+ 25		°C	
3	Overtone Order	-	Fundamental			
4	Load Capacitance	C_L	∞		pF	
5	Rated Drive Level	P_0	0.1		mW	
6	Frequency Adjustment Tolerance	$\frac{\Delta f}{f}$	-15	+ 15	10^{-6}	At T_0 °C
7	Resonance Resistance	R_r	-	100	Ω	Over T_{op} °C
8	Frequency Variation with Temperature over T_{op}	$\frac{\Delta f}{f}$	Not applicable		10^{-6}	
9	Resistance Variation with Temperature over T_{op}	$\frac{\Delta R}{R}$	Not applicable		%	
10	Operating Temperature Range	T_{op}	-20	+ 70	°C	
11	Frequency variation with Drive Level	$\frac{\Delta f}{f}$	Not applicable		10^{-6}	
12	Resistance variation with Drive Level	$\frac{\Delta R}{R}$	Not applicable		%	
13	Motional Inductance	L_1	Not applicable		mH	
14	Motional Capacitance	C_1	Not applicable		fF	
15	Static Capacitance	C_0	-	4.0	pF	
16	Q Factor	Q	80 000	-	-	
17	Ratio of Unwanted: Response Resistance to Resonance Resistance or Response Impedance to Resonance Resistance	R_p/R or $ Z_{pl}/R$	2:1	-		In the frequency range: $f_r - 200\text{kHz}$ to $f_r + 200\text{kHz}$
18	Ageing	$\frac{\Delta f}{f}$	Not applicable		10^{-6}	
19	Lead Finish	-	2		-	



TABLE 1(a) - TYPE VARIANT DETAILED INFORMATION

TYPE VARIANT NO. 06

No.	Characteristics	Symbol	Limits		Unit	Remarks
			Min.	Max.		
1	Resonance Frequency	f_r	4.095		MHz	
2	Reference Temperature	T_o	+25		°C	
3	Overtone Order	-	Fundamental			
4	Load Capacitance	C_L	∞		pF	
5	Rated Drive Level	P_o	0.1		mW	
6	Frequency Adjustment Tolerance	$\frac{\Delta f}{f}$	-5.0	+5.0	10^{-6}	At T_o °C
7	Resonance Resistance	R_r	-	15	Ω	At T_o °C
8	Frequency Variation with Temperature over T_{op}	$\frac{\Delta f}{f}$	-10	+10	10^{-6}	From frequency measured at T_o °C
9	Resistance Variation with Temperature over T_{op}	$\frac{\Delta R}{R}$	-10 or -1.5	+10 +1.5	% Ω	From resistance measured at T_o °C If $R < 10\Omega$
10	Operating Temperature Range	T_{op}	-30	+60	°C	
11	Frequency variation with Drive Level	$\frac{\Delta f}{f}$	Not applicable		10^{-6}	
12	Resistance variation with Drive Level	$\frac{\Delta R}{R}$	Not applicable		%	
13	Motional Inductance	L_1	157.5	192.5	mH	
14	Motional Capacitance	C_1	Not applicable		fF	
15	Static Capacitance	C_o	Not applicable		pF	
16	Q Factor	Q	Not applicable		-	
17	Ratio of Unwanted: Response Resistance to Resonance Resistance or Response Impedance to Resonance Resistance	R_p/R Z_p /R	3:1	-		In the frequency range: $f_r - 10\text{kHz}$ to $f_r + 10\text{kHz}$
18	Ageing	$\frac{\Delta f}{f}$	-2.0	+2.0	10^{-6}	After burn-in and per year
19	Lead Finish	-	2		-	

TABLE 1(a) - TYPE VARIANT DETAILED INFORMATION

TYPE VARIANT NO. 07

No.	Characteristics	Symbol	Limits		Unit	Remarks
			Min.	Max.		
1	Resonance Frequency	f_L	5.0		MHz	
2	Reference Temperature	T_0	+ 40		°C	
3	Overtone Order	-	Fundamental			
4	Load Capacitance	C_L	30		pF	
5	Rated Drive Level	P_0	0.1		mW	
6	Frequency Adjustment Tolerance	$\frac{\Delta f}{f}$	-10	+ 10	10^{-6}	At T_0 °C
7	Resonance Resistance	R_r	-	20	Ω	Over T_{op} °C
8	Frequency Variation with Temperature over T_{op}	$\frac{\Delta f}{f}$	-10	+ 10	10^{-6}	From frequency measured at T_0 °C
9	Resistance Variation with Temperature over T_{op}	$\frac{\Delta R}{R}$	Not applicable		%	
10	Operating Temperature Range	T_{op}	-10	+ 70	°C	
11	Frequency variation with Drive Level	$\frac{\Delta f}{f}$	Not applicable		10^{-6}	
12	Resistance variation with Drive Level	$\frac{\Delta R}{R}$	Not applicable		%	
13	Motional Inductance	L_1	76.5	103.5	mH	
14	Motional Capacitance	C_1	Not applicable		fF	
15	Static Capacitance	C_0	-	4.0	pF	
16	Q Factor	Q	100 000	-	-	
17	Ratio of Unwanted: Response Resistance to Resonance Resistance or Response Impedance to Resonance Resistance	R_p/R $I Z_p/R$	2:1	-		In the frequency range: f_L -500kHz to f_L +500kHz
18	Ageing	$\frac{\Delta f}{f}$	-10	+ 10	10^{-6}	Over 5 years of storage and 3000 operating hours
19	Lead Finish	-	2		-	

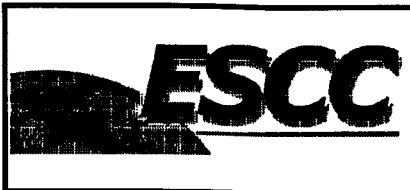

TABLE 1(a) - TYPE VARIANT DETAILED INFORMATION

TYPE VARIANT NO. 08

No.	Characteristics	Symbol	Limits		Unit	Remarks
			Min.	Max.		
1	Resonance Frequency	f_L	5.105555		MHz	
2	Reference Temperature	T_o	+ 25		°C	
3	Overtone Order	-	Fundamental			
4	Load Capacitance	C_L	30		pF	
5	Rated Drive Level	P_o	0.1		mW	
6	Frequency Adjustment Tolerance	$\frac{\Delta f}{f}$	-10	+ 10	10^{-6}	At T_o °C
7	Resonance Resistance	R_r	-	15	Ω	Over T_{op} °C
8	Frequency Variation with Temperature over T_{op}	$\frac{\Delta f}{f}$	-50	+ 50	10^{-6}	From frequency measured at T_o °C
9	Resistance Variation with Temperature over T_{op}	$\frac{\Delta R}{R}$	Not applicable		%	
10	Operating Temperature Range	T_{op}	-55	+ 105	°C	
11	Frequency variation with Drive Level	$\frac{\Delta f}{f}$	Not applicable		10^{-6}	
12	Resistance variation with Drive Level	$\frac{\Delta R}{R}$	Not applicable		%	
13	Motional Inductance	L_1	Not applicable		mH	
14	Motional Capacitance	C_1	Not applicable		fF	
15	Static Capacitance	C_o	-	7.0	pF	
16	Q Factor	Q	100 000	-	-	
17	Ratio of Unwanted: Response Resistance to Resonance Resistance or Response Impedance to Resonance Resistance	R_p/R or $ Z_p /R$	3:1	-		In the frequency range: $f_L - 200\text{kHz}$ to $f_L + 200\text{kHz}$
18	Ageing	$\frac{\Delta f}{f}$	-2.0	+ 2.0	10^{-6}	After burn-in and per year
19	Lead Finish	-	2		-	

TABLE 1(a) - TYPE VARIANT DETAILED INFORMATION

TYPE VARIANT NO. 09

No.	Characteristics	Symbol	Limits		Unit	Remarks
			Min.	Max.		
1	Resonance Frequency	f_L	5.333 to 5.334		MHz	
2	Reference Temperature	T_0	+ 15		°C	
3	Overtone Order	-	Fundamental			
4	Load Capacitance	C_L	140		pF	
5	Rated Drive Level	P_0	0.1		mW	
6	Frequency Adjustment Tolerance	$\frac{\Delta f}{f}$	-7.0	+7.0	10^{-6}	At T_0 °C
7	Resonance Resistance	R_r	-	15	Ω	Over T_{op} °C
8	Frequency Variation with Temperature over T_{op}	$\frac{\Delta f}{f}$	Not applicable		10^{-6}	
9	Resistance Variation with Temperature over T_{op}	$\frac{\Delta R}{R}$	Not applicable		%	
10	Operating Temperature Range	T_{op}	-20	+ 60	°C	
11	Frequency variation with Drive Level	$\frac{\Delta f}{f}$	Not applicable		10^{-6}	
12	Resistance variation with Drive Level	$\frac{\Delta R}{R}$	Not applicable		%	
13	Motional Inductance	L_1	Not applicable		mH	
14	Motional Capacitance	C_1	Not applicable		fF	
15	Static Capacitance	C_0	Not applicable		pF	
16	Q Factor	Q	Not applicable		-	
17	Ratio of Unwanted: Response Resistance to Resonance Resistance or Response Impedance to Resonance Resistance	R_p/R or $ Z_p /R$	Not applicable			
18	Ageing	$\frac{\Delta f}{f}$	Not applicable		10^{-6}	
19	Lead Finish	-	2		-	

TABLE 1(a) - TYPE VARIANT DETAILED INFORMATION

TYPE VARIANT NO. 10

No.	Characteristics	Symbol	Limits		Unit	Remarks
			Min.	Max.		
1	Resonance Frequency	f_L	5.661448		MHz	
2	Reference Temperature	T_o	+25		°C	
3	Overtone Order	-	Fundamental			
4	Load Capacitance	C_L	22	33	pF	
5	Rated Drive Level	P_o	0.1		mW	
6	Frequency Adjustment Tolerance	$\frac{\Delta f}{f}$	Not applicable		10^{-6}	
7	Resonance Resistance	R_r	-	25	Ω	Over T_{op} °C
8	Frequency Variation with Temperature over T_{op}	$\frac{\Delta f}{f}$	-5.0	+5.0	10^{-6}	From frequency measured at T_o °C
9	Resistance Variation with Temperature over T_{op}	$\frac{\Delta R}{R}$	Not applicable		%	
10	Operating Temperature Range	T_{op}	-30	+60	°C	
11	Frequency variation with Drive Level	$\frac{\Delta f}{f}$	Not applicable		10^{-6}	
12	Resistance variation with Drive Level	$\frac{\Delta R}{R}$	Not applicable		%	
13	Motional Inductance	L_1	Not applicable		mH	
14	Motional Capacitance	C_1	Not applicable		fF	
15	Static Capacitance	C_o	3.2	4.0	pF	
16	Q Factor	Q	Not applicable		-	
17	Ratio of Unwanted: Response Resistance to Resonance Resistance or Response Impedance to Resonance Resistance	R_p/R or iZ_p/R	3:1	-		In the frequency range: f_L -200kHz to f_L +200kHz
18	Ageing	$\frac{\Delta f}{f}$	Not applicable		10^{-6}	
19	Lead Finish	-	2		-	

TABLE 1(a) - TYPE VARIANT DETAILED INFORMATION

TYPE VARIANT NO. 11

No.	Characteristics	Symbol	Limits		Unit	Remarks
			Min.	Max.		
1	Resonance Frequency	f_r	8.7 to 10.7		MHz	
2	Reference Temperature	T_0	+25		°C	
3	Overtone Order	-	Fundamental			
4	Load Capacitance	C_L	∞		pF	
5	Rated Drive Level	P_0	0.1		mW	
6	Frequency Adjustment Tolerance	$\frac{\Delta f}{f}$	-10	+10	10^{-6}	At T_0 °C
7	Resonance Resistance	R_r	-	15	Ω	Over T_{op} °C
8	Frequency Variation with Temperature over T_{op}	$\frac{\Delta f}{f}$	-40	+40	10^{-6}	From frequency measured at T_0 °C
9	Resistance Variation with Temperature over T_{op}	$\frac{\Delta R}{R}$	Not applicable		%	
10	Operating Temperature Range	T_{op}	-40	+80	°C	
11	Frequency variation with Drive Level	$\frac{\Delta f}{f}$	Not applicable		10^{-6}	
12	Resistance variation with Drive Level	$\frac{\Delta R}{R}$	Not applicable		%	
13	Motional Inductance	L_1	Not applicable		mH	
14	Motional Capacitance	C_1	Not applicable		fF	
15	Static Capacitance	C_0	Not applicable		pF	
16	Q Factor	Q	Not applicable		-	
17	Ratio of Unwanted: Response Resistance to Resonance Resistance or Response Impedance to Resonance Resistance	R_p/R or $ Z_p /R$	4:1	-		In the frequency range: $f_r -10\%$ to $f_r +10\%$
18	Ageing	$\frac{\Delta f}{f}$	Not applicable		10^{-6}	
19	Lead Finish	-	2		-	

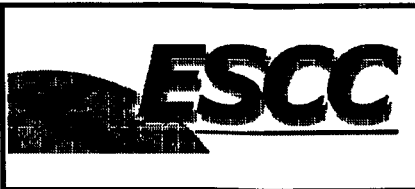

TABLE 1(a) - TYPE VARIANT DETAILED INFORMATION

TYPE VARIANT NO. 12

	Characteristics	Symbol	Limits		Unit	Remarks
			Min.	Max.		
1	Resonance Frequency	f_r	10.0		MHz	
2	Reference Temperature	T_0	+60		°C	
3	Overtone Order	-	Fundamental			
4	Load Capacitance	C_L	∞		pF	
5	Rated Drive Level	P_0	0.1		mW	
6	Frequency Adjustment Tolerance	$\frac{\Delta f}{f}$	-10	+10	10^{-6}	At T_0 °C
7	Resonance Resistance	R_r	-	20	Ω	Over T_{op} °C
8	Frequency Variation with Temperature over T_{op}	$\frac{\Delta f}{f}$	-15	+15	10^{-6}	From frequency measured at T_0 °C
9	Resistance Variation with Temperature over T_{op}	$\frac{\Delta R}{R}$	Not applicable		%	
10	Operating Temperature Range	T_{op}	-20	+70	°C	
11	Frequency variation with Drive Level	$\frac{\Delta f}{f}$	Not applicable		10^{-6}	
12	Resistance variation with Drive Level	$\frac{\Delta R}{R}$	Not applicable		%	
13	Motional Inductance	L_1	Not applicable		mH	
14	Motional Capacitance	C_1	Not applicable		fF	
15	Static Capacitance	C_0	-	4.5	pF	
16	Q Factor	Q	Not applicable		-	
17	Ratio of Unwanted: Response Resistance to Resonance Resistance or Response Impedance to Resonance Resistance	R_p/R or $ Z_p /R$	3:1	-		In the frequency range: $f_r - 200\text{kHz}$ to $f_r + 200\text{kHz}$
18	Ageing	$\frac{\Delta f}{f}$	-3.0	+3.0	10^{-6}	After burn-in and per year
19	Lead Finish	-	2		-	

TABLE 1(a) - TYPE VARIANT DETAILED INFORMATION

TYPE VARIANT NO. 13

No.	Characteristics	Symbol	Limits		Unit	Remarks
			Min.	Max.		
1	Resonance Frequency	f_L	10.0		MHz	
2	Reference Temperature	T_0	+25		°C	
3	Overtone Order	-	Fundamental			
4	Load Capacitance	C_L	50		pF	
5	Rated Drive Level	P_0	0.1		mW	
6	Frequency Adjustment Tolerance	$\frac{\Delta f}{f}$	-10	+10	10^{-6}	At T_0 °C
7	Resonance Resistance	R_L	-	20	Ω	Over T_{op} °C
8	Frequency Variation with Temperature over T_{op}	$\frac{\Delta f}{f}$	-10	+10	10^{-6}	From frequency measured at T_0 °C
9	Resistance Variation with Temperature over T_{op}	$\frac{\Delta R}{R}$	Not applicable		%	
10	Operating Temperature Range	T_{op}	-10	+80	°C	
11	Frequency variation with Drive Level	$\frac{\Delta f}{f}$	Not applicable		10^{-6}	
12	Resistance variation with Drive Level	$\frac{\Delta R}{R}$	Not applicable		%	
13	Motional Inductance	L_1	12.15	16.45	mH	
14	Motional Capacitance	C_1	Not applicable		fF	
15	Static Capacitance	C_0	-	5.0	pF	
16	Q Factor	Q	100 000	-	-	
17	Ratio of Unwanted: Response Resistance to Resonance Resistance or Response Impedance to Resonance Resistance	R_p/R or $ Z_p /R$	3:1	-		In the frequency range: f_L -500kHz to f_L + 500kHz
18	Ageing	$\frac{\Delta f}{f}$	-2.0	+2.0	10^{-6}	After burn-in and per year
19	Lead Finish	-	2		-	

TABLE 1(a) - TYPE VARIANT DETAILED INFORMATION

TYPE VARIANT NO. 14

No.	Characteristics	Symbol	Limits		Unit	Remarks
			Min.	Max.		
1	Resonance Frequency	f_L	10.7		MHz	
2	Reference Temperature	T_0	+25		°C	
3	Overtone Order	-	Fundamental			
4	Load Capacitance	C_L	30		pF	
5	Rated Drive Level	P_0	0.1		mW	
6	Frequency Adjustment Tolerance	$\frac{\Delta f}{f}$	-10	+10	10^{-6}	At T_0 °C
7	Resonance Resistance	R_L	-	15	Ω	Over T_{op} °C
8	Frequency Variation with Temperature over T_{op}	$\frac{\Delta f}{f}$	-50	+50	10^{-6}	From frequency measured at T_0 °C
9	Resistance Variation with Temperature over T_{op}	$\frac{\Delta R}{R}$	Not applicable		%	
10	Operating Temperature Range	T_{op}	-55	+105	°C	
11	Frequency variation with Drive Level	$\frac{\Delta f}{f}$	Not applicable		10^{-6}	
12	Resistance variation with Drive Level	$\frac{\Delta R}{R}$	Not applicable		%	
13	Motional Inductance	L_1	Not applicable		mH	
14	Motional Capacitance	C_1	Not applicable		fF	
15	Static Capacitance	C_0	-	7.0	pF	
16	Q Factor	Q	70 000	-	-	
17	Ratio of Unwanted: Response Resistance to Resonance Resistance or Response Impedance to Resonance Resistance	R_p/R or $ Z_p /R$	3:1	-		In the frequency range: $f_L - 200\text{kHz}$ to $f_L + 200\text{kHz}$
18	Ageing	$\frac{\Delta f}{f}$	-2.0	+2.0	10^{-6}	After burn-in and per year
19	Lead Finish	-	2		-	

TABLE 1(a) - TYPE VARIANT DETAILED INFORMATION

TYPE VARIANT NO. 15

No.	Characteristics	Symbol	Limits		Unit	Remarks
			Min.	Max.		
1	Resonance Frequency	f_L	11.0		MHz	
2	Reference Temperature	T_0	+25		°C	
3	Overtone Order	-	Fundamental			
4	Load Capacitance	C_L	30		pF	
5	Rated Drive Level	P_0	0.1		mW	
6	Frequency Adjustment Tolerance	$\frac{\Delta f}{f}$	-10	+10	10^{-6}	At T_0 °C
7	Resonance Resistance	R_L	-	15	Ω	Over T_{op} °C
8	Frequency Variation with Temperature over T_{op}	$\frac{\Delta f}{f}$	-50	+50	10^{-6}	From frequency measured at T_0 °C
9	Resistance Variation with Temperature over T_{op}	$\frac{\Delta R}{R}$	Not applicable		%	
10	Operating Temperature Range	T_{op}	-55	+105	°C	
11	Frequency variation with Drive Level	$\frac{\Delta f}{f}$	Not applicable		10^{-6}	
12	Resistance variation with Drive Level	$\frac{\Delta R}{R}$	Not applicable		%	
13	Motional Inductance	L_1	Not applicable		mH	
14	Motional Capacitance	C_1	Not applicable		fF	
15	Static Capacitance	C_0	-	7.0	pF	
16	Q Factor	Q	70 000	-	-	
17	Ratio of Unwanted: Response Resistance to Resonance Resistance or Response Impedance to Resonance Resistance	R_p/R $ Z_p /R$	3:1	-		In the frequency range: $f_L - 200\text{kHz}$ to $f_L + 200\text{kHz}$
18	Ageing	$\frac{\Delta f}{f}$	-2.0	+2.0	10^{-6}	After burn-in and per year
19	Lead Finish	-	2		-	

TABLE 1(a) - TYPE VARIANT DETAILED INFORMATION

TYPE VARIANT NO. 16

No.	Characteristics	Symbol	Limits		Unit	Remarks
			Min.	Max.		
1	Resonance Frequency	f_L	11.433333		MHz	
2	Reference Temperature	T_0	+25		°C	
3	Overtone Order	-	Fundamental			
4	Load Capacitance	C_L	20		pF	
5	Rated Drive Level	P_0	0.1		mW	
6	Frequency Adjustment Tolerance	$\frac{\Delta f}{f}$	-5.0	+5.0	10 ⁻⁶	At T_0 °C
7	Resonance Resistance	R_L	-	15	Ω	Over T_{op} °C
8	Frequency Variation with Temperature over T_{op}	$\frac{\Delta f}{f}$	-8.0	+8.0	10 ⁻⁶	From frequency measured at T_0 °C
9	Resistance Variation with Temperature over T_{op}	$\frac{\Delta R}{R}$	Not applicable		%	
10	Operating Temperature Range	T_{op}	-20	+80	°C	
11	Frequency variation with Drive Level	$\frac{\Delta f}{f}$	Not applicable		10 ⁻⁶	
12	Resistance variation with Drive Level	$\frac{\Delta R}{R}$	Not applicable		%	
13	Motional Inductance	L_1	Not applicable		mH	
14	Motional Capacitance	C_1	Not applicable		fF	
15	Static Capacitance	C_0	-	5.0	pF	
16	Q Factor	Q	Not applicable		-	
17	Ratio of Unwanted: Response Resistance to Resonance Resistance or Response Impedance to Resonance Resistance	R_p/R or $ Z_p /R$	2:1	-		In the frequency range: f_L -200kHz to f_L + 200kHz
18	Ageing	$\frac{\Delta f}{f}$	-2.0	+2.0	10 ⁻⁶	After burn-in and per year
19	Lead Finish	-	2		-	

TABLE 1(a) - TYPE VARIANT DETAILED INFORMATION

TYPE VARIANT NO. 17

	Characteristics	Symbol	Limits		Unit	Remarks
			Min.	Max.		
1	Resonance Frequency	f_L	12.8		MHz	
2	Reference Temperature	T_o	+25		°C	
3	Overtone Order	-	Fundamental			
4	Load Capacitance	C_L	30		pF	
5	Rated Drive Level	P_o	0.1		mW	
6	Frequency Adjustment Tolerance	$\frac{\Delta f}{f}$	-10	+10	10 ⁻⁶	At T_o °C
7	Resonance Resistance	R_L	-	15	Ω	Over T_{op} °C
8	Frequency Variation with Temperature over T_{op}	$\frac{\Delta f}{f}$	-50	+50	10 ⁻⁶	From frequency measured at T_o °C
9	Resistance Variation with Temperature over T_{op}	$\frac{\Delta R}{R}$	Not applicable		%	
10	Operating Temperature Range	T_{op}	-55	+105	°C	
11	Frequency variation with Drive Level	$\frac{\Delta f}{f}$	Not applicable		10 ⁻⁶	
12	Resistance variation with Drive Level	$\frac{\Delta R}{R}$	Not applicable		%	
13	Motional Inductance	L_1	Not applicable		mH	
14	Motional Capacitance	C_1	Not applicable		fF	
15	Static Capacitance	C_o	-	7.0	pF	
16	Q Factor	Q	70 000	-	-	
17	Ratio of Unwanted: Response Resistance to Resonance Resistance or Response Impedance to Resonance Resistance	R_p/R or $ Z_p /R$	3:1	-		In the frequency range: $f_L - 200\text{kHz}$ to $f_L + 200\text{kHz}$
18	Ageing	$\frac{\Delta f}{f}$	-2.0	+2.0	10 ⁻⁶	After burn-in and per year
19	Lead Finish	-	2		-	

TABLE 1(a) - TYPE VARIANT DETAILED INFORMATION

TYPE VARIANT NO. 18

No.	Characteristics	Symbol	Limits		Unit	Remarks
			Min.	Max.		
1	Resonance Frequency	f_r	14.7456		MHz	
2	Reference Temperature	T_o	+ 25		°C	
3	Overtone Order	-	Fundamental			
4	Load Capacitance	C_L	∞		pF	
5	Rated Drive Level	P_o	0.1		mW	
6	Frequency Adjustment Tolerance	$\frac{\Delta f}{f}$	-10	+ 10	10^{-6}	At T_o °C
7	Resonance Resistance	R_r	-	25	Ω	Over T_{op} °C
8	Frequency Variation with Temperature over T_{op}	$\frac{\Delta f}{f}$	-15	+ 15	10^{-6}	From frequency measured at T_o °C
9	Resistance Variation with Temperature over T_{op}	$\frac{\Delta R}{R}$	Not applicable		%	
10	Operating Temperature Range	T_{op}	-20	+ 70	°C	
11	Frequency variation with Drive Level	$\frac{\Delta f}{f}$	Not applicable		10^{-6}	
12	Resistance variation with Drive Level	$\frac{\Delta R}{R}$	Not applicable		%	
13	Motional Inductance	L_1	Not applicable		mH	
14	Motional Capacitance	C_1	Not applicable		fF	
15	Static Capacitance	C_o	-	7.0	pF	
16	Q Factor	Q	50 000	-	-	
17	Ratio of Unwanted: Response Resistance to Resonance Resistance or Response Impedance to Resonance Resistance	R_p/R or $ Z_p /R$	Not applicable			
18	Ageing	$\frac{\Delta f}{f}$	-5.0	+ 5.0	10^{-6}	After burn-in and per year
19	Lead Finish	-	2		-	

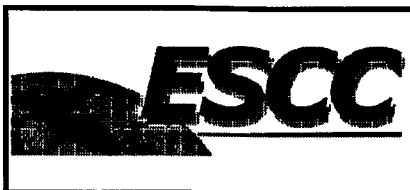

TABLE 1(a) - TYPE VARIANT DETAILED INFORMATION

TYPE VARIANT NO. 19

No.	Characteristics	Symbol	Limits		Unit	Remarks
			Min.	Max.		
1	Resonance Frequency	f_r	12.0		MHz	
2	Reference Temperature	T_0	+25		°C	
3	Overtone Order	-	Fundamental			
4	Load Capacitance	C_L	∞		pF	
5	Rated Drive Level	P_0	0.1		mW	
6	Frequency Adjustment Tolerance	$\frac{\Delta f}{f}$	-10	+10	10^{-6}	At T_0 °C
7	Resonance Resistance	R_r	-	25	Ω	Over T_{op} °C
8	Frequency Variation with Temperature over T_{op}	$\frac{\Delta f}{f}$	-15	+15	10^{-6}	From frequency measured at T_0 °C
9	Resistance Variation with Temperature over T_{op}	$\frac{\Delta R}{R}$	Not applicable		%	
10	Operating Temperature Range	T_{op}	-20	+70	°C	
11	Frequency variation with Drive Level	$\frac{\Delta f}{f}$	Not applicable		10^{-6}	
12	Resistance variation with Drive Level	$\frac{\Delta R}{R}$	Not applicable		%	
13	Motional Inductance	L_1	Not applicable		mH	
14	Motional Capacitance	C_1	Not applicable		fF	
15	Static Capacitance	C_0	-	7.0	pF	
16	Q Factor	Q	50 000	-	-	
17	Ratio of Unwanted: Response Resistance to Resonance Resistance or Response Impedance to Resonance Resistance	R_p/R or $ Z_p /R$	Not applicable			
18	Ageing	$\frac{\Delta f}{f}$	-5.0	+5.0	10^{-6}	After burn-in and per year
19	Lead Finish	-	2		-	

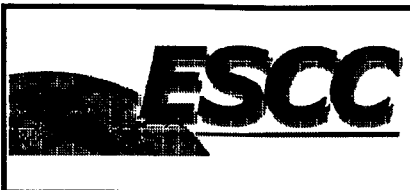

TABLE 1(a) - TYPE VARIANT DETAILED INFORMATION

TYPE VARIANT NO. 20

No.	Characteristics	Symbol	Limits		Unit	Remarks
			Min.	Max.		
1	Resonance Frequency	f_L	12.288		MHz	
2	Reference Temperature	T_0	+60		°C	
3	Overtone Order	-	Fundamental			
4	Load Capacitance	C_L	20	50	pF	
5	Rated Drive Level	P_0	0.1		mW	
6	Frequency Adjustment Tolerance	$\frac{\Delta f}{f}$	-10	+10	10^{-6}	At T_0 °C
7	Resonance Resistance	R_L	-	20	Ω	At T_0 °C
8	Frequency Variation with Temperature over T_{op}	$\frac{\Delta f}{f}$	-10	+10	10^{-6}	From frequency measured at T_0 °C
9	Resistance Variation with Temperature over T_{op}	$\frac{\Delta R}{R}$	-10 or -1.5	+10 +1.5	% Ω	From resistance measured at T_0 °C If $R < 10\Omega$
10	Operating Temperature Range	T_{op}	-30	+70	°C	
11	Frequency variation with Drive Level	$\frac{\Delta f}{f}$	Not applicable		10^{-6}	
12	Resistance variation with Drive Level	$\frac{\Delta R}{R}$	Not applicable		%	
13	Motional Inductance	L_1	4.76	6.44	mH	
14	Motional Capacitance	C_1	Not applicable		fF	
15	Static Capacitance	C_0	-	7.0	pF	
16	Q Factor	Q	25 000	-	-	
17	Ratio of Unwanted: Response Resistance to Resonance Resistance or Response Impedance to Resonance Resistance	R_p/R or $ Z_p /R$	2:1	-		In the frequency range: $f_L - 200\text{kHz}$ to $f_L + 200\text{kHz}$
18	Ageing	$\frac{\Delta f}{f}$	-10	+10	10^{-6}	After burn-in and per year
19	Lead Finish	-	2		-	

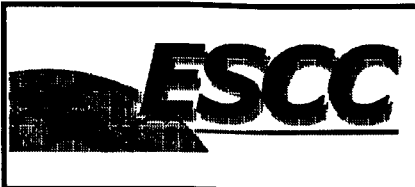

TABLE 1(a) - TYPE VARIANT DETAILED INFORMATION

TYPE VARIANT NO. 21

No.	Characteristics	Symbol	Limits		Unit	Remarks
			Min.	Max.		
1	Resonance Frequency	f_L	15.0		MHz	
2	Reference Temperature	T_0	+ 25		°C	
3	Overtone Order	-	Fundamental			
4	Load Capacitance	C_L	25		pF	
5	Rated Drive Level	P_0	0.1		mW	
6	Frequency Adjustment Tolerance	$\frac{\Delta f}{f}$	-10	+ 10	10^{-6}	At T_0 °C
7	Resonance Resistance	R_L	-	35	Ω	At T_0 °C
8	Frequency Variation with Temperature over T_{op}	$\frac{\Delta f}{f}$	-20	+ 20	10^{-6}	From frequency measured at T_0 °C
9	Resistance Variation with Temperature over T_{op}	$\frac{\Delta R}{R}$	-10 or -1.5	+ 10 + 1.5	% Ω	From resistance measured at T_0 °C If $R < 10\Omega$
10	Operating Temperature Range	T_{op}	-30	+ 80	°C	
11	Frequency variation with Drive Level	$\frac{\Delta f}{f}$	Not applicable		10^{-6}	
12	Resistance variation with Drive Level	$\frac{\Delta R}{R}$	Not applicable		%	
13	Motional Inductance	L_1	Not applicable		mH	
14	Motional Capacitance	C_1	-	8.5	fF	
15	Static Capacitance	C_0	-	8.5	pF	
16	Q Factor	Q	65 000	-	-	
17	Ratio of Unwanted: Response Resistance to Resonance Resistance or Response Impedance to Resonance Resistance	R_p/R or $ Z_p /R$	2:1	-		In the frequency range: $f_L - 200\text{kHz}$ to $f_L + 200\text{kHz}$
18	Ageing	$\frac{\Delta f}{f}$	-10	+ 10	10^{-6}	After burn-in and per year
19	Lead Finish	-	2		-	

TABLE 1(a) - TYPE VARIANT DETAILED INFORMATION

TYPE VARIANT NO. 22

	Characteristics	Symbol	Limits		Unit	Remarks
			Min.	Max.		
1	Resonance Frequency	f_L	4.096		MHz	
2	Reference Temperature	T_0	+25		°C	
3	Overtone Order	-	Fundamental			
4	Load Capacitance	C_L	50		pF	
5	Rated Drive Level	P_0	0.1		mW	
6	Frequency Adjustment Tolerance	$\frac{\Delta f}{f}$	-10	+10	10^{-6}	At T_0 °C
7	Resonance Resistance	R_L	-	20	Ω	At T_0 °C
8	Frequency Variation with Temperature over T_{op}	$\frac{\Delta f}{f}$	-10	+10	10^{-6}	From frequency measured at T_0 °C
9	Resistance Variation with Temperature over T_{op}	$\frac{\Delta R}{R}$	-10 or -1.5	+10 +1.5	% Ω	From resistance measured at T_0 °C If $R < 10\Omega$
10	Operating Temperature Range	T_{op}	-20	+80	°C	
11	Frequency variation with Drive Level	$\frac{\Delta f}{f}$	Not applicable		10^{-6}	
12	Resistance variation with Drive Level	$\frac{\Delta R}{R}$	Not applicable		%	
13	Motional Inductance	L_1	131.75	178.25	mH	
14	Motional Capacitance	C_1	Not applicable		fF	
15	Static Capacitance	C_0	-	7.0	pF	
16	Q Factor	Q	80 000	-	-	
17	Ratio of Unwanted: Response Resistance to Resonance Resistance or Response Impedance to Resonance Resistance	R_p/R or $ Z_p /R$	3:1	-		In the frequency range: $f_L - 200\text{kHz}$ to $f_L + 200\text{kHz}$
18	Ageing	$\frac{\Delta f}{f}$	-5.0	+5.0	10^{-6}	After burn-in and per year
19	Lead Finish	-	2		-	

TABLE 1(a) - TYPE VARIANT DETAILED INFORMATION

TYPE VARIANT NO. 22

	Characteristics	Symbol	Limits		Unit	Remarks
			Min.	Max.		
1	Resonance Frequency	f_L	4.096		MHz	
2	Reference Temperature	T_o	+25		°C	
3	Overtone Order	-	Fundamental			
4	Load Capacitance	C_L	50		pF	
5	Rated Drive Level	P_o	0.1		mW	
6	Frequency Adjustment Tolerance	$\frac{\Delta f}{f}$	-10	+10	10^{-6}	At T_o °C
7	Resonance Resistance	R_L	-	20	Ω	At T_o °C
8	Frequency Variation with Temperature over T_{op}	$\frac{\Delta f}{f}$	-10	+10	10^{-6}	From frequency measured at T_o °C
9	Resistance Variation with Temperature over T_{op}	$\frac{\Delta R}{R}$	-10 or -1.5	+10 +1.5	% Ω	From resistance measured at T_o °C If $R < 10\Omega$
10	Operating Temperature Range	T_{op}	-20	+80	°C	
11	Frequency variation with Drive Level	$\frac{\Delta f}{f}$	Not applicable		10^{-6}	
12	Resistance variation with Drive Level	$\frac{\Delta R}{R}$	Not applicable		%	
13	Motional Inductance	L_1	131.75	178.25	mH	
14	Motional Capacitance	C_1	Not applicable		fF	
15	Static Capacitance	C_o	-	7.0	pF	
16	Q Factor	Q	80 000	-	-	
17	Ratio of Unwanted: Response Resistance to Resonance Resistance or Response Impedance to Resonance Resistance	R_p/R $ Z_p /R$	3:1	-		In the frequency range: $f_L - 200\text{kHz}$ to $f_L + 200\text{kHz}$
18	Ageing	$\frac{\Delta f}{f}$	-5.0	+5.0	10^{-6}	After burn-in and per year
19	Lead Finish	-	3 or 4		-	



TABLE 1(a) - TYPE VARIANT DETAILED INFORMATION

TYPE VARIANT NO. 23

No.	Characteristics	Symbol	Limits		Unit	Remarks
			Min.	Max.		
1	Resonance Frequency	f_r	19.109567		MHz	
2	Reference Temperature	T_o	+25		°C	
3	Overtone Order	-	Fundamental			
4	Load Capacitance	C_L	∞		pF	
5	Rated Drive Level	P_o	0.1		mW	
6	Frequency Adjustment Tolerance	$\frac{\Delta f}{f}$	-5.0	+5.0	10^{-6}	At T_o °C
7	Resonance Resistance	R_r	-	15	Ω	At T_o °C
8	Frequency Variation with Temperature over T_{op}	$\frac{\Delta f}{f}$	-10	+10	10^{-6}	From frequency measured at T_o °C
9	Resistance Variation with Temperature over T_{op}	$\frac{\Delta R}{R}$	-10 or -1.5	+10 +1.5	% Ω	From resistance measured at T_o °C If $R < 10\Omega$
10	Operating Temperature Range	T_{op}	-30	+60	°C	
11	Frequency variation with Drive Level	$\frac{\Delta f}{f}$	Not applicable		10^{-6}	
12	Resistance variation with Drive Level	$\frac{\Delta R}{R}$	Not applicable		%	
13	Motional Inductance	L_1	2.25	2.75	mH	
14	Motional Capacitance	C_1	Not applicable		fF	
15	Static Capacitance	C_o	Not applicable		pF	
16	Q Factor	Q	Not applicable		-	
17	Ratio of Unwanted: Response Resistance to Resonance Resistance or Response Impedance to Resonance Resistance	R_p/R or $ Z_p /R$	Not applicable			
18	Ageing	$\frac{\Delta f}{f}$	-1.0	+1.0	10^{-6}	After burn-in and per year
19	Lead Finish	-	2		-	



TABLE 1(a) - TYPE VARIANT DETAILED INFORMATION

TYPE VARIANT NO. 24

No.	Characteristics	Symbol	Limits		Unit	Remarks
			Min.	Max.		
1	Resonance Frequency	f_r	6.4		MHz	
2	Reference Temperature	T_0	+25		°C	
3	Overtone Order	-	Fundamental			
4	Load Capacitance	C_L	∞		pF	
5	Rated Drive Level	P_0	0.1		mW	
6	Frequency Adjustment Tolerance	$\frac{\Delta f}{f}$	-10	+10	10^{-6}	At T_0 °C
7	Resonance Resistance	R_r	-	180	Ω	At T_0 °C
8	Frequency Variation with Temperature over T_{op}	$\frac{\Delta f}{f}$	-40	+40	10^{-6}	From frequency measured at T_0 °C
9	Resistance Variation with Temperature over T_{op}	$\frac{\Delta R}{R}$	-10 or -1.5	+10 +1.5	% Ω	From resistance measured at T_0 °C If $R < 10\Omega$
10	Operating Temperature Range	T_{op}	-20	+60	°C	
11	Frequency variation with Drive Level	$\frac{\Delta f}{f}$	Not applicable		10^{-6}	
12	Resistance variation with Drive Level	$\frac{\Delta R}{R}$	Not applicable		%	
13	Motional Inductance	L_1	Not applicable		mH	
14	Motional Capacitance	C_1	Not applicable		fF	
15	Static Capacitance	C_0	Not applicable		pF	
16	Q Factor	Q	Not applicable		-	
17	Ratio of Unwanted: Response Resistance to Resonance Resistance or Response Impedance to Resonance Resistance	R_p/R or $ Z_p /R$	Not applicable			
18	Ageing	$\frac{\Delta f}{f}$	-3.0	+3.0	10^{-6}	After burn-in and per year
19	Lead Finish	-	2		-	



TABLE 1(a) - TYPE VARIANT DETAILED INFORMATION

TYPE VARIANT NO. 25

No.	Characteristics	Symbol	Limits		Unit	Remarks
			Min.	Max.		
1	Resonance Frequency	f_r	7.0		MHz	
2	Reference Temperature	T_o	+25		°C	
3	Overtone Order	-	Fundamental			
4	Load Capacitance	C_L	∞		pF	
5	Rated Drive Level	P_o	0.1		mW	
6	Frequency Adjustment Tolerance	$\frac{\Delta f}{f}$	-10	+10	10^{-6}	At T_o °C
7	Resonance Resistance	R_r	-	180	Ω	At T_o °C
8	Frequency Variation with Temperature over T_{op}	$\frac{\Delta f}{f}$	-40	+40	10^{-6}	From frequency measured at T_o °C
9	Resistance Variation with Temperature over T_{op}	$\frac{\Delta R}{R}$	-10 or -1.5	+10 +1.5	% Ω	From resistance measured at T_o °C If $R < 10\Omega$
10	Operating Temperature Range	T_{op}	-20	+60	°C	
11	Frequency variation with Drive Level	$\frac{\Delta f}{f}$	Not applicable		10^{-6}	
12	Resistance variation with Drive Level	$\frac{\Delta R}{R}$	Not applicable		%	
13	Motional Inductance	L_1	Not applicable		mH	
14	Motional Capacitance	C_1	Not applicable		fF	
15	Static Capacitance	C_o	Not applicable		pF	
16	Q Factor	Q	Not applicable		-	
17	Ratio of Unwanted: Response Resistance to Resonance Resistance or Response Impedance to Resonance Resistance	R_p/R or $ Z_p /R$	Not applicable			
18	Ageing	$\frac{\Delta f}{f}$	-3.0	+3.0	10^{-6}	After burn-in and per year
19	Lead Finish	-	2		-	

TABLE 1(a) - TYPE VARIANT DETAILED INFORMATION

TYPE VARIANT NO. 26

No.	Characteristics	Symbol	Limits		Unit	Remarks
			Min.	Max.		
1	Resonance Frequency	f_L	12.0		MHz	
2	Reference Temperature	T_o	+25		°C	
3	Overtone Order	-	Fundamental			
4	Load Capacitance	C_L	30		pF	
5	Rated Drive Level	P_o	0.1		mW	
6	Frequency Adjustment Tolerance	$\frac{\Delta f}{f}$	-10	+10	10^{-6}	At T_o °C
7	Resonance Resistance	R_L	-	180	Ω	At T_o °C
8	Frequency Variation with Temperature over T_{op}	$\frac{\Delta f}{f}$	-40	+40	10^{-6}	From frequency measured at T_o °C
9	Resistance Variation with Temperature over T_{op}	$\frac{\Delta R}{R}$	-10 or -1.5	+10 +1.5	% Ω	From resistance measured at T_o °C If $R < 10\Omega$
10	Operating Temperature Range	T_{op}	-20	+60	°C	
11	Frequency variation with Drive Level	$\frac{\Delta f}{f}$	Not applicable		10^{-6}	
12	Resistance variation with Drive Level	$\frac{\Delta R}{R}$	Not applicable		%	
13	Motional Inductance	L_1	Not applicable		mH	
14	Motional Capacitance	C_1	Not applicable		fF	
15	Static Capacitance	C_o	Not applicable		pF	
16	Q Factor	Q	Not applicable		-	
17	Ratio of Unwanted: Response Resistance to Resonance Resistance or Response Impedance to Resonance Resistance	R_p/R or $ Z_p /R$	Not applicable			
18	Ageing	$\frac{\Delta f}{f}$	-3.0	+3.0	10^{-6}	After burn-in and per year
19	Lead Finish	-	2		-	

TABLE 1(a) - TYPE VARIANT DETAILED INFORMATION

TYPE VARIANT NO. 27

	Characteristics	Symbol	Limits		Unit	Remarks
			Min.	Max.		
1	Resonance Frequency	f_L	15.0		MHz	
2	Reference Temperature	T_o	+25		°C	
3	Overtone Order	-	Fundamental			
4	Load Capacitance	C_L	20	50	pF	
5	Rated Drive Level	P_o	0.1		mW	
6	Frequency Adjustment Tolerance	$\frac{\Delta f}{f}$	-10	+10	10^{-6}	At T_o °C
7	Resonance Resistance	R_L	-	20	Ω	Over T_{op} °C
8	Frequency Variation with Temperature over T_{op}	$\frac{\Delta f}{f}$	-40	+40	10^{-6}	From frequency measured at T_o °C
9	Resistance Variation with Temperature over T_{op}	$\frac{\Delta R}{R}$	Not applicable		%	
10	Operating Temperature Range	T_{op}	-20	+70	°C	
11	Frequency variation with Drive Level	$\frac{\Delta f}{f}$	Not applicable		10^{-6}	
12	Resistance variation with Drive Level	$\frac{\Delta R}{R}$	Not applicable		%	
13	Motional Inductance	L_1	Not applicable		mH	
14	Motional Capacitance	C_1	Not applicable		fF	
15	Static Capacitance	C_o	Not applicable		pF	
16	Q Factor	Q	Not applicable		-	
17	Ratio of Unwanted: Response Resistance to Resonance Resistance or Response Impedance to Resonance Resistance	R_p/R or $ Z_p /R$	Not applicable			
18	Ageing	$\frac{\Delta f}{f}$	-3.0	+3.0	10^{-6}	After burn-in and per year
19	Lead Finish	-	2		-	

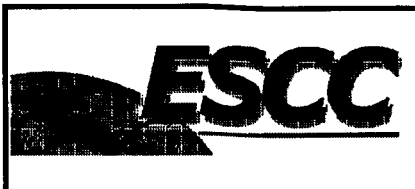

TABLE 1(a) - TYPE VARIANT DETAILED INFORMATION

TYPE VARIANT NO. 28

No.	Characteristics	Symbol	Limits		Unit	Remarks
			Min.	Max.		
1	Resonance Frequency	f_L	6.4		MHz	
2	Reference Temperature	T_o	+ 25		°C	
3	Overtone Order	-	Fundamental			
4	Load Capacitance	C_L	30		pF	
5	Rated Drive Level	P_o	0.1		mW	
6	Frequency Adjustment Tolerance	$\frac{\Delta f}{f}$	-10	+ 10	10^{-6}	At T_o °C
7	Resonance Resistance	R_L	-	20	Ω	At T_o °C
8	Frequency Variation with Temperature over T_{op}	$\frac{\Delta f}{f}$	-10	+ 10	10^{-6}	From frequency measured at T_o °C
9	Resistance Variation with Temperature over T_{op}	$\frac{\Delta R}{R}$	-10 or -1.5	+ 10 + 1.5	% Ω	From resistance measured at T_o °C If $R < 10\Omega$
10	Operating Temperature Range	T_{op}	-20	+ 60	°C	
11	Frequency variation with Drive Level	$\frac{\Delta f}{f}$	Not applicable		10^{-6}	
12	Resistance variation with Drive Level	$\frac{\Delta R}{R}$	Not applicable		%	
13	Motional Inductance	L_1	-	50	mH	
14	Motional Capacitance	C_1	Not applicable		fF	
15	Static Capacitance	C_o	-	7.0	pF	
16	Q Factor	Q	150 000	-	-	
17	Ratio of Unwanted: Response Resistance to Resonance Resistance or Response Impedance to Resonance Resistance	R_p/R $ Z_p /R$	3:1	-		In the frequency range: $f_L - 200\text{kHz}$ to $f_L + 200\text{kHz}$
18	Ageing	$\frac{\Delta f}{f}$	-3.0	+ 3.0	10^{-6}	After burn-in and per year
19	Lead Finish	-	2		-	

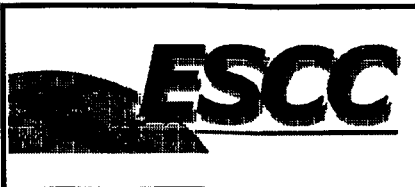

TABLE 1(a) - TYPE VARIANT DETAILED INFORMATION

TYPE VARIANT NO. 29

No.	Characteristics	Symbol	Limits		Unit	Remarks
			Min.	Max.		
1	Resonance Frequency	f_L	7.0		MHz	
2	Reference Temperature	T_0	+25		°C	
3	Overtone Order	-	Fundamental			
4	Load Capacitance	C_L	30		pF	
5	Rated Drive Level	P_0	0.1		mW	
6	Frequency Adjustment Tolerance	$\frac{\Delta f}{f}$	-10	+10	10^{-6}	At T_0 °C
7	Resonance Resistance	R_L	-	20	Ω	At T_0 °C
8	Frequency Variation with Temperature over T_{op}	$\frac{\Delta f}{f}$	-10	+10	10^{-6}	From frequency measured at T_0 °C
9	Resistance Variation with Temperature over T_{op}	$\frac{\Delta R}{R}$	-10 or -1.5	+10 +1.5	% Ω	From resistance measured at T_0 °C If $R < 10\Omega$
10	Operating Temperature Range	T_{op}	-20	+60	°C	
11	Frequency variation with Drive Level	$\frac{\Delta f}{f}$	Not applicable		10^{-6}	
12	Resistance variation with Drive Level	$\frac{\Delta R}{R}$	Not applicable		%	
13	Motional Inductance	L_1	-	40	mH	
14	Motional Capacitance	C_1	Not applicable		fF	
15	Static Capacitance	C_0	-	7.0	pF	
16	Q Factor	Q	100 000	-	-	
17	Ratio of Unwanted: Response Resistance to Resonance Resistance or Response Impedance to Resonance Resistance	R_p/R or $ Z_p /R$	3:1	-		In the frequency range: $f_L - 200\text{kHz}$ to $f_L + 200\text{kHz}$
18	Ageing	$\frac{\Delta f}{f}$	-3.0	+3.0	10^{-6}	After burn-in and per year
19	Lead Finish	-	2		-	

TABLE 1(a) - TYPE VARIANT DETAILED INFORMATION

TYPE VARIANT NO. 30

No.	Characteristics	Symbol	Limits		Unit	Remarks
			Min.	Max.		
1	Resonance Frequency	f_L	12.0		MHz	
2	Reference Temperature	T_0	+ 40		°C	
3	Overtone Order	-	Fundamental			
4	Load Capacitance	C_L	50		pF	
5	Rated Drive Level	P_0	0.1		mW	
6	Frequency Adjustment Tolerance	$\frac{\Delta f}{f}$	-10	+ 10	10^{-6}	At T_0 °C
7	Resonance Resistance	R_L	-	13	Ω	At T_0 °C
8	Frequency Variation with Temperature over T_{op}	$\frac{\Delta f}{f}$	-15	+ 15	10^{-6}	From frequency measured at T_0 °C
9	Resistance Variation with Temperature over T_{op}	$\frac{\Delta R}{R}$	-10	+ 10	%	From resistance measured at T_0 °C if $R < 10\Omega$
			-1.5	+ 1.5	Ω	
10	Operating Temperature Range	T_{op}	-20	+ 80	°C	
11	Frequency variation with Drive Level	$\frac{\Delta f}{f}$	Not applicable		10^{-6}	
12	Resistance variation with Drive Level	$\frac{\Delta R}{R}$	Not applicable		%	
13	Motional Inductance	L_1	6.97	9.43	mH	
14	Motional Capacitance	C_1	Not applicable		fF	
15	Static Capacitance	C_0	-	7.0	pF	
16	Q Factor	Q	75 000	-	-	
17	Ratio of Unwanted: Response Resistance to Resonance Resistance or Response Impedance to Resonance Resistance	R_p/R or $ Z_p /R$	3:1	-		In the frequency range: $f_L - 200\text{kHz}$ to $f_L + 200\text{kHz}$
18	Ageing	$\frac{\Delta f}{f}$	-3.0	+ 3.0	10^{-6}	After burn-in and per year
19	Lead Finish	-	2		-	

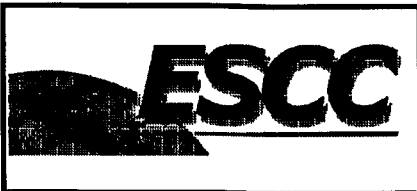

TABLE 1(a) - TYPE VARIANT DETAILED INFORMATION

TYPE VARIANT NO. 31

No.	Characteristics	Symbol	Limits		Unit	Remarks
			Min.	Max.		
1	Resonance Frequency	f_L	4.608		MHz	
2	Reference Temperature	T_0	+25		°C	
3	Overtone Order	-	Fundamental			
4	Load Capacitance	C_L	30		pF	
5	Rated Drive Level	P_0	0.1		mW	
6	Frequency Adjustment Tolerance	$\frac{\Delta f}{f}$	-10	+10	10^{-6}	At T_0 °C
7	Resonance Resistance	R_L	-	20	Ω	At T_0 °C
8	Frequency Variation with Temperature over T_{op}	$\frac{\Delta f}{f}$	-12	+12	10^{-6}	From frequency measured at T_0 °C
9	Resistance Variation with Temperature over T_{op}	$\frac{\Delta R}{R}$	-10 -1.5	+10 +1.5	% Ω	From resistance measured at T_0 °C If $R < 10\Omega$
10	Operating Temperature Range	T_{op}	-35	+70	°C	
11	Frequency variation with Drive Level	$\frac{\Delta f}{f}$	Not applicable		10^{-6}	
12	Resistance variation with Drive Level	$\frac{\Delta R}{R}$	-20	+20	%	From $P_{S1} = 0.05mW$ to $P_{S2} = 0.2mW$
13	Motional Inductance	L_1	Not applicable		mH	
14	Motional Capacitance	C_1	Not applicable		fF	
15	Static Capacitance	C_0	-	7.0	pF	
16	Q Factor	Q	800 000	-	-	
17	Ratio of Unwanted: Response Resistance to Resonance Resistance or Response Impedance to Resonance Resistance	R_p/R or $ Z_p /R$	Not applicable			
18	Ageing	$\frac{\Delta f}{f}$	-10	+10	10^{-6}	After burn-in, after 5 years
19	Lead Finish	-	2		-	



TABLE 1(a) - TYPE VARIANT DETAILED INFORMATION

TYPE VARIANT NO. 32

	Characteristics	Symbol	Limits		Unit	Remarks
			Min.	Max.		
1	Resonance Frequency	f_L	10.0		MHz	
2	Reference Temperature	T_0	+ 40		°C	
3	Overtone Order	-	Fundamental			
4	Load Capacitance	C_L	50		pF	
5	Rated Drive Level	P_0	0.1		mW	
6	Frequency Adjustment Tolerance	$\frac{\Delta f}{f}$	-10	+ 10	10^{-6}	At T_0 °C
7	Resonance Resistance	R_L	-	13	Ω	At T_0 °C
8	Frequency Variation with Temperature over T_{op}	$\frac{\Delta f}{f}$	-15	+ 15	10^{-6}	From frequency measured at T_0 °C
9	Resistance Variation with Temperature over T_{op}	$\frac{\Delta R}{R}$	-10	+ 10 or -1.5 + 1.5	% Ω	From resistance measured at T_0 °C If $R < 10\Omega$
10	Operating Temperature Range	T_{op}	-20	+ 80	°C	
11	Frequency variation with Drive Level	$\frac{\Delta f}{f}$	Not applicable		10^{-6}	
12	Resistance variation with Drive Level	$\frac{\Delta R}{R}$	Not applicable		%	
13	Motional Inductance	L_1	Not applicable		mH	
14	Motional Capacitance	C_1	Not applicable		fF	
15	Static Capacitance	C_0	-	10	pF	
16	Q Factor	Q	50 000	-	-	
17	Ratio of Unwanted: Response Resistance to Resonance Resistance or Response Impedance to Resonance Resistance	R_p/R or $ Z_p /R$	3:1	-		In the frequency range: $f_L - 200\text{kHz}$ to $f_L + 200\text{kHz}$
18	Ageing	$\frac{\Delta f}{f}$	-3.0	+ 3.0	10^{-6}	After burn-in and per year
19	Lead Finish	-	2		-	



TABLE 1(a) - TYPE VARIANT DETAILED INFORMATION

TYPE VARIANT NO. 33

No.	Characteristics	Symbol	Limits		Unit	Remarks
			Min.	Max.		
1	Resonance Frequency	f_L	13.3		MHz	
2	Reference Temperature	T_o	+ 25		°C	
3	Overtone Order	-	Fundamental			
4	Load Capacitance	C_L	30		pF	
5	Rated Drive Level	P_o	0.1		mW	
6	Frequency Adjustment Tolerance	$\frac{\Delta f}{f}$	-10	+ 10	10^{-6}	At T_o °C
7	Resonance Resistance	R_L	-	20	Ω	At T_o °C
8	Frequency Variation with Temperature over T_{op}	$\frac{\Delta f}{f}$	-10	+ 10	10^{-6}	From frequency measured at T_o °C
9	Resistance Variation with Temperature over T_{op}	$\frac{\Delta R}{R}$	-10 or -1.5	+ 10 + 1.5	% Ω	From resistance measured at T_o °C If $R < 10\Omega$
10	Operating Temperature Range	T_{op}	-35	+ 70	°C	
11	Frequency variation with Drive Level	$\frac{\Delta f}{f}$	Not applicable		10^{-6}	
12	Resistance variation with Drive Level	$\frac{\Delta R}{R}$	-20	+ 20	%	From $P_{S1} = 0.05mW$ to $P_{S2} = 0.2mW$
13	Motional Inductance	L_1	Not applicable		mH	
14	Motional Capacitance	C_1	Not applicable		fF	
15	Static Capacitance	C_o	-	10	pF	
16	Q Factor	Q	100 000	-	-	
17	Ratio of Unwanted: Response Resistance to Resonance Resistance or Response Impedance to Resonance Resistance	R_p/R or $ Z_p /R$	Not applicable			
18	Ageing	$\frac{\Delta f}{f}$	-10	+ 10	10^{-6}	After burn-in, after 5 years
19	Lead Finish	-	2		-	

TABLE 1(a) - TYPE VARIANT DETAILED INFORMATION

TYPE VARIANT NO. 34

No.	Characteristics	Symbol	Limits		Unit	Remarks
			Min.	Max.		
1	Resonance Frequency	f_L	3.2768		MHz	
2	Reference Temperature	T_0	+27		°C	
3	Overtone Order	-	Fundamental			
4	Load Capacitance	C_L	27	33	pF	
5	Rated Drive Level	P_0	0.1		mW	
6	Frequency Adjustment Tolerance	$\frac{\Delta f}{f}$	-10	+10	10^{-6}	At T_0 °C
7	Resonance Resistance	R_L	-	180	Ω	At T_0 °C
8	Frequency Variation with Temperature over T_{op}	$\frac{\Delta f}{f}$	-5.0	+5.0	10^{-6}	From frequency measured at T_0 °C
9	Resistance Variation with Temperature over T_{op}	$\frac{\Delta R}{R}$	-10	+10	%	From resistance measured at T_0 °C If $R < 10\Omega$
			-1.5	+1.5	Ω	
10	Operating Temperature Range	T_{op}	-20	+50	°C	
11	Frequency variation with Drive Level	$\frac{\Delta f}{f}$	Not applicable		10^{-6}	
12	Resistance variation with Drive Level	$\frac{\Delta R}{R}$	Not applicable		%	
13	Motional Inductance	L_1	300	400	mH	
14	Motional Capacitance	C_1	Not applicable		fF	
15	Static Capacitance	C_0	-	7.0	pF	
16	Q Factor	Q	50 000	-	-	
17	Ratio of Unwanted: Response Resistance to Resonance Resistance or Response Impedance to Resonance Resistance	R_p/R or $ Z_{pl}/R$	2:1	-		In the frequency range: $f_L - 200\text{kHz}$ to $f_L + 200\text{kHz}$
18	Ageing	$\frac{\Delta f}{f}$	-3.0	+3.0	10^{-6}	After burn-in and per year
19	Lead Finish	-	2		-	

TABLE 1(a) - TYPE VARIANT DETAILED INFORMATION

TYPE VARIANT NO. 35

No.	Characteristics	Symbol	Limits		Unit	Remarks
			Min.	Max.		
1	Resonance Frequency	f_L	8.0		MHz	
2	Reference Temperature	T_0	+25	+29	°C	
3	Overtone Order	-	Fundamental			
4	Load Capacitance	C_L	30		pF	
5	Rated Drive Level	P_0	0.1		mW	
6	Frequency Adjustment Tolerance	$\frac{\Delta f}{f}$	-20	+20	10^{-6}	At T_0 °C
7	Resonance Resistance	R_L	-	13	Ω	Over T_{op} °C
8	Frequency Variation with Temperature over T_{op}	$\frac{\Delta f}{f}$	-15	+15	10^{-6}	From frequency measured at T_0 °C
9	Resistance Variation with Temperature over T_{op}	$\frac{\Delta R}{R}$	Not applicable		%	
10	Operating Temperature Range	T_{op}	-20	+50	°C	
11	Frequency variation with Drive Level	$\frac{\Delta f}{f}$	Not applicable		10^{-6}	
12	Resistance variation with Drive Level	$\frac{\Delta R}{R}$	Not applicable		%	
13	Motional Inductance	L_1	23	30	mH	
14	Motional Capacitance	C_1	Not applicable		fF	
15	Static Capacitance	C_0	-	7.0	pF	
16	Q Factor	Q	100 000	-	-	
17	Ratio of Unwanted: Response Resistance to Resonance Resistance or Response Impedance to Resonance Resistance	R_p/R or $ Z_p /R$	Not applicable			
18	Ageing	$\frac{\Delta f}{f}$	-5.0	+5.0	10^{-6}	After burn-in and per year
19	Lead Finish	-	2		-	

TABLE 1(a) - TYPE VARIANT DETAILED INFORMATION

TYPE VARIANT NO. 36

No.	Characteristics	Symbol	Limits		Unit	Remarks
			Min.	Max.		
1	Resonance Frequency	f_L	6.0		MHz	
2	Reference Temperature	T_0	+ 25		°C	
3	Overtone Order	-	Fundamental			
4	Load Capacitance	C_L	16		pF	
5	Rated Drive Level	P_0	0.1		mW	
6	Frequency Adjustment Tolerance	$\frac{\Delta f}{f}$	-10	+ 10	10^{-6}	At T_0 °C
7	Resonance Resistance	R_L	-	50	Ω	At T_0 °C
8	Frequency Variation with Temperature over T_{op}	$\frac{\Delta f}{f}$	-50	+ 50	10^{-6}	From frequency measured at T_0 °C
9	Resistance Variation with Temperature over T_{op}	$\frac{\Delta R}{R}$	-10	+ 10	%	From resistance measured at T_0 °C If $R < 10\Omega$
			-1.5	+ 1.5	Ω	
10	Operating Temperature Range	T_{op}	-20	+ 70	°C	
11	Frequency variation with Drive Level	$\frac{\Delta f}{f}$	Not applicable		10^{-6}	
12	Resistance variation with Drive Level	$\frac{\Delta R}{R}$	Not applicable		%	
13	Motional Inductance	L_1	Not applicable		mH	
14	Motional Capacitance	C_1	Not applicable		fF	
15	Static Capacitance	C_0	Not applicable		pF	
16	Q Factor	Q	Not applicable		-	
17	Ratio of Unwanted: Response Resistance to Resonance Resistance or Response Impedance to Resonance Resistance	R_p/R or $ Z_p /R$	Not applicable			
18	Ageing	$\frac{\Delta f}{f}$	-3.0	+ 3.0	10^{-6}	After burn-in and per year
19	Lead Finish	-	2		-	

TABLE 1(a) - TYPE VARIANT DETAILED INFORMATION

TYPE VARIANT NO. 37

	Characteristics	Symbol	Limits		Unit	Remarks
			Min.	Max.		
1	Resonance Frequency	f_L	4.608		MHz	
2	Reference Temperature	T_0	+25		°C	
3	Overtone Order	-	Fundamental			
4	Load Capacitance	C_L	27	33	pF	
5	Rated Drive Level	P_0	0.1		mW	
6	Frequency Adjustment Tolerance	$\frac{\Delta f}{f}$	-10	+10	10^{-6}	At T_0 °C
7	Resonance Resistance	R_L	-	20	Ω	At T_0 °C
8	Frequency Variation with Temperature over T_{op}	$\frac{\Delta f}{f}$	-15	+15	10^{-6}	From frequency measured at T_0 °C
9	Resistance Variation with Temperature over T_{op}	$\frac{\Delta R}{R}$	-10	+10	%	From resistance measured at T_0 °C If $R < 10\Omega$
			-1.5	+1.5	Ω	
10	Operating Temperature Range	T_{op}	-35	+70	°C	
11	Frequency variation with Drive Level	$\frac{\Delta f}{f}$	Not applicable		10^{-6}	
12	Resistance variation with Drive Level	$\frac{\Delta R}{R}$	Not applicable		%	
13	Motional Inductance	L_1	Not applicable		mH	
14	Motional Capacitance	C_1	Not applicable		fF	
15	Static Capacitance	C_0	Not applicable		pF	
16	Q Factor	Q	70 000	-	-	
17	Ratio of Unwanted: Response Resistance to Resonance Resistance or Response Impedance to Resonance Resistance	R_p/R or $ Z_p /R$	Not applicable			
18	Ageing	$\frac{\Delta f}{f}$	-3.0	+3.0	10^{-6}	After burn-in and per year
19	Lead Finish	-	2		-	

TABLE 1(a) - TYPE VARIANT DETAILED INFORMATION

TYPE VARIANT NO. 38

No.	Characteristics	Symbol	Limits		Unit	Remarks
			Min.	Max.		
1	Resonance Frequency	f_L	4.608		MHz	
2	Reference Temperature	T_0	+25		°C	
3	Overtone Order	-	Fundamental			
4	Load Capacitance	C_L	30		pF	
5	Rated Drive Level	P_0	0.1		mW	
6	Frequency Adjustment Tolerance	$\frac{\Delta f}{f}$	-8.0	+8.0	10^{-6}	At T_0 °C
7	Resonance Resistance	R_L	-	10	Ω	At T_0 °C
8	Frequency Variation with Temperature over T_{op}	$\frac{\Delta f}{f}$	-15	+15	10^{-6}	From frequency measured at T_0 °C
9	Resistance Variation with Temperature over T_{op}	$\frac{\Delta R}{R}$	-10 or -1.5	+10 +1.5	% Ω	From resistance measured at T_0 °C If $R < 10\Omega$
10	Operating Temperature Range	T_{op}	-40	+70	°C	
11	Frequency variation with Drive Level	$\frac{\Delta f}{f}$	Not applicable		10^{-6}	
12	Resistance variation with Drive Level	$\frac{\Delta R}{R}$	-20	+20	%	From $P_{S1} = 0.05mW$ to $P_{S2} = 0.2mW$
13	Motional Inductance	L_1	Not applicable		mH	
14	Motional Capacitance	C_1	Not applicable		fF	
15	Static Capacitance	C_0	-	7.0	pF	
16	Q Factor	Q	400 000	-	-	
17	Ratio of Unwanted: Response Resistance to Resonance Resistance or Response Impedance to Resonance Resistance	R_p/R or $ Z_p /R$	Not applicable			
18	Ageing	$\frac{\Delta f}{f}$	-10	+10	10^{-6}	After burn-in over 5 years
19	Lead Finish	-	2		-	

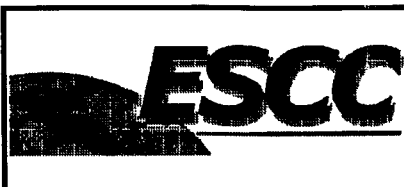

TABLE 1(a) - TYPE VARIANT DETAILED INFORMATION

TYPE VARIANT NO. 39

No.	Characteristics	Symbol	Limits		Unit	Remarks
			Min.	Max.		
1	Resonance Frequency	f_L	5.0		MHz	
2	Reference Temperature	T_o	+ 25		°C	
3	Overtone Order	-	Fundamental			
4	Load Capacitance	C_L	27		pF	
5	Rated Drive Level	P_o	0.1		mW	
6	Frequency Adjustment Tolerance	$\frac{\Delta f}{f}$	-10	+ 10	10^{-6}	At T_o °C
7	Resonance Resistance	R_L	-	200	Ω	Over T_o °C
8	Frequency Variation with Temperature over T_{op}	$\frac{\Delta f}{f}$	-50	+ 50	10^{-6}	From frequency measured at T_o °C
9	Resistance Variation with Temperature over T_{op}	$\frac{\Delta R}{R}$	Not applicable		%	
10	Operating Temperature Range	T_{op}	-40	+ 70	°C	
11	Frequency variation with Drive Level	$\frac{\Delta f}{f}$	Not applicable		10^{-6}	
12	Resistance variation with Drive Level	$\frac{\Delta R}{R}$	Not applicable		%	From $P_{S1} = 0.05mW$ to $P_{S2} = 0.2mW$
13	Motional Inductance	L_1	Not applicable		mH	
14	Motional Capacitance	C_1	Not applicable		fF	
15	Static Capacitance	C_o	Not applicable		pF	
16	Q Factor	Q	Not applicable		-	
17	Ratio of Unwanted: Response Resistance to Resonance Resistance or Response Impedance to Resonance Resistance	R_p/R or $ Z_p /R$	Not applicable			
18	Ageing	$\frac{\Delta f}{f}$	-50	+ 50	10^{-6}	Over 6 years
19	Lead Finish	-	2		-	

TABLE 1(a) - TYPE VARIANT DETAILED INFORMATION

TYPE VARIANT NO. 40

No.	Characteristics	Symbol	Limits		Unit	Remarks
			Min.	Max.		
1	Resonance Frequency	f_L	3.2768		MHz	
2	Reference Temperature	T_0	+25		°C	
3	Overtone Order	-	Fundamental			
4	Load Capacitance	C_L	20	50	pF	
5	Rated Drive Level	P_0	0.1		mW	
6	Frequency Adjustment Tolerance	$\frac{\Delta f}{f}$	-10	+10	10^{-6}	At T_0 °C
7	Resonance Resistance	R_L	-	12	Ω	Over T_{op} °C
8	Frequency Variation with Temperature over T_{op}	$\frac{\Delta f}{f}$	-5.0	+5.0	10^{-6}	From frequency measured at T_0 °C
9	Resistance Variation with Temperature over T_{op}	$\frac{\Delta R}{R}$	Not applicable		%	
10	Operating Temperature Range	T_{op}	-20	+70	°C	
11	Frequency variation with Drive Level	$\frac{\Delta f}{f}$	Not applicable		10^{-6}	
12	Resistance variation with Drive Level	$\frac{\Delta R}{R}$	Not applicable		%	
13	Motional Inductance	L_1	200	-	mH	
14	Motional Capacitance	C_1	Not applicable		fF	
15	Static Capacitance	C_0	-	2.7	pF	
16	Q Factor	Q	400 000	-	-	
17	Ratio of Unwanted: Response Resistance to Resonance Resistance or Response Impedance to Resonance Resistance	R_p/R or $ Z_{pl}/R$	2:1	-		In the frequency range: $f_L - 300\text{kHz}$ to $f_L + 300\text{kHz}$
18	Ageing	$\frac{\Delta f}{f}$	-5.0	+5.0	10^{-6}	After burn-in, per year
19	Lead Finish	-	2		-	



TABLE 1(a) - TYPE VARIANT DETAILED INFORMATION

TYPE VARIANT NO. 41

No.	Characteristics	Symbol	Limits		Unit	Remarks
			Min.	Max.		
1	Resonance Frequency	f_L	4.096		MHz	
2	Reference Temperature	T_o	+ 25		°C	
3	Overtone Order	-	Fundamental			
4	Load Capacitance	C_L	50		pF	
5	Rated Drive Level	P_o	0.1		mW	
6	Frequency Adjustment Tolerance	$\frac{\Delta f}{f}$	-10	+ 10	10^{-6}	At T_o °C
7	Resonance Resistance	R_L	-	20	Ω	Over T_{op} °C
8	Frequency Variation with Temperature over T_{op}	$\frac{\Delta f}{f}$	-10	+ 10	10^{-6}	From frequency measured at T_o °C
9	Resistance Variation with Temperature over T_{op}	$\frac{\Delta R}{R}$	Not applicable		%	
10	Operating Temperature Range	T_{op}	-10	+ 80	°C	
11	Frequency variation with Drive Level	$\frac{\Delta f}{f}$	Not applicable		10^{-6}	
12	Resistance variation with Drive Level	$\frac{\Delta R}{R}$	Not applicable		%	
13	Motional Inductance	L_1	78	-	mH	
14	Motional Capacitance	C_1	Not applicable		fF	
15	Static Capacitance	C_o	-	5.0	pF	
16	Q Factor	Q	100 000	-	-	
17	Ratio of Unwanted: Response Resistance to Resonance Resistance or Response Impedance to Resonance Resistance	R_p/R $ Z_p /R$	3:1	-		In the frequency range: f_L -400kHz to f_L + 400kHz
18	Ageing	$\frac{\Delta f}{f}$	-3.0	+ 3.0	10^{-6}	After burn-in, per year
19	Lead Finish	-	2		-	



TABLE 1(a) - TYPE VARIANT DETAILED INFORMATION

TYPE VARIANT NO. 42

	Characteristics	Symbol	Limits		Unit	Remarks
			Min.	Max.		
1	Resonance Frequency	f_L	5.0		MHz	
2	Reference Temperature	T_0	+ 40		°C	
3	Overtone Order	-	Fundamental			
4	Load Capacitance	C_L	30		pF	
5	Rated Drive Level	P_0	0.1		mW	
6	Frequency Adjustment Tolerance	$\frac{\Delta f}{f}$	-5.0	+ 5.0	10^{-6}	At T_0 °C
7	Resonance Resistance	R_L	-	20	Ω	Over T_{op} °C
8	Frequency Variation with Temperature over T_{op}	$\frac{\Delta f}{f}$	-8.0	+ 8.0	10^{-6}	From frequency measured at T_0 °C
9	Resistance Variation with Temperature over T_{op}	$\frac{\Delta R}{R}$	Not applicable		%	
10	Operating Temperature Range	T_{op}	-20	+ 80	°C	
11	Frequency variation with Drive Level	$\frac{\Delta f}{f}$	Not applicable		10^{-6}	
12	Resistance variation with Drive Level	$\frac{\Delta R}{R}$	Not applicable		%	
13	Motional Inductance	L_1	64	-	mH	
14	Motional Capacitance	C_1	Not applicable		fF	
15	Static Capacitance	C_0	-	4.0	pF	
16	Q Factor	Q	100 000	-	-	
17	Ratio of Unwanted: Response Resistance to Resonance Resistance or Response Impedance to Resonance Resistance	R_p/R or $ Z_p /R$	2:1	-		In the frequency range: $f_L - 500\text{kHz}$ to $f_L + 500\text{kHz}$
18	Ageing	$\frac{\Delta f}{f}$	-3.0	+ 3.0	10^{-6}	After burn-in, per year
19	Lead Finish	-	2		-	

TABLE 1(a) - TYPE VARIANT DETAILED INFORMATION

TYPE VARIANT NO. 43

No.	Characteristics	Symbol	Limits		Unit	Remarks
			Min.	Max.		
1	Resonance Frequency	f_L	5.0		MHz	
2	Reference Temperature	T_0	+ 40		°C	
3	Overtone Order	-	Fundamental			
4	Load Capacitance	C_L	30		pF	
5	Rated Drive Level	P_0	0.1		mW	
6	Frequency Adjustment Tolerance	$\frac{\Delta f}{f}$	-10	+ 10	10^{-6}	At T_0 °C
7	Resonance Resistance	R_L	-	20	Ω	Over T_{op} °C
8	Frequency Variation with Temperature over T_{op}	$\frac{\Delta f}{f}$	-10	+ 10	10^{-6}	From frequency measured at T_0 °C
9	Resistance Variation with Temperature over T_{op}	$\frac{\Delta R}{R}$	Not applicable		%	
10	Operating Temperature Range	T_{op}	-10	+ 70	°C	
11	Frequency variation with Drive Level	$\frac{\Delta f}{f}$	Not applicable		10^{-6}	
12	Resistance variation with Drive Level	$\frac{\Delta R}{R}$	Not applicable		%	
13	Motional Inductance	L_1	64	-	mH	
14	Motional Capacitance	C_1	Not applicable		fF	
15	Static Capacitance	C_0	-	4.0	pF	
16	Q Factor	Q	100 000	-	-	
17	Ratio of Unwanted: Response Resistance to Resonance Resistance or Response Impedance to Resonance Resistance	R_p/R or $ Z_p /R$	2:1	-		In the frequency range: $f_L - 300\text{kHz}$ to $f_L + 300\text{kHz}$
18	Ageing	$\frac{\Delta f}{f}$	-10	+ 10	10^{-6}	After burn-in, per year
19	Lead Finish	-	2		-	

TABLE 1(a) - TYPE VARIANT DETAILED INFORMATION

TYPE VARIANT NO. 44

No.	Characteristics	Symbol	Limits		Unit	Remarks
			Min.	Max.		
1	Resonance Frequency	f_L	10.0		MHz	
2	Reference Temperature	T_0	+ 25		°C	
3	Overtone Order	-	Fundamental			
4	Load Capacitance	C_L	50		pF	
5	Rated Drive Level	P_0	0.1		mW	
6	Frequency Adjustment Tolerance	$\frac{\Delta f}{f}$	-10	+ 10	10^{-6}	At T_0 °C
7	Resonance Resistance	R_L	-	20	Ω	Over T_{op} °C
8	Frequency Variation with Temperature over T_{op}	$\frac{\Delta f}{f}$	-10	+ 10	10^{-6}	From frequency measured at T_0 °C
9	Resistance Variation with Temperature over T_{op}	$\frac{\Delta R}{R}$	Not applicable		%	
10	Operating Temperature Range	T_{op}	-10	+ 80	°C	
11	Frequency variation with Drive Level	$\frac{\Delta f}{f}$	Not applicable		10^{-6}	
12	Resistance variation with Drive Level	$\frac{\Delta R}{R}$	Not applicable		%	
13	Motional Inductance	L_1	32	-	mH	
14	Motional Capacitance	C_1	Not applicable		fF	
15	Static Capacitance	C_0	-	5.0	pF	
16	Q Factor	Q	100 000	-	-	
17	Ratio of Unwanted: Response Resistance to Resonance Resistance or Response Impedance to Resonance Resistance	R_p/R or $ Z_p /R$	3:1	-		In the frequency range: $f_L - 500\text{kHz}$ to $f_L + 500\text{kHz}$
18	Ageing	$\frac{\Delta f}{f}$	-3.0	+ 3.0	10^{-6}	After burn-in, per year
19	Lead Finish	-	2		-	

TABLE 1(a) - TYPE VARIANT DETAILED INFORMATION

TYPE VARIANT NO. 45

No.	Characteristics	Symbol	Limits		Unit	Remarks
			Min.	Max.		
1	Resonance Frequency	f_r	12.0		MHz	
2	Reference Temperature	T_o	+23	+27	°C	
3	Overtone Order	-	Fundamental			
4	Load Capacitance	C_L	∞		pF	
5	Rated Drive Level	P_o	0.1		mW	
6	Frequency Adjustment Tolerance	$\frac{\Delta f}{f}$	-10	+10	10^{-6}	At T_o °C
7	Resonance Resistance	R_r	-	20	Ω	At T_o °C
8	Frequency Variation with Temperature over T_{op}	$\frac{\Delta f}{f}$	-10	+10	10^{-6}	From frequency measured at T_o °C
9	Resistance Variation with Temperature over T_{op}	$\frac{\Delta R}{R}$	-10 or -1.5	+10 +1.5	% Ω	From resistance measured at T_o °C If $R < 10\Omega$
10	Operating Temperature Range	T_{op}	-20	+70	°C	
11	Frequency variation with Drive Level	$\frac{\Delta f}{f}$	Not applicable		10^{-6}	
12	Resistance variation with Drive Level	$\frac{\Delta R}{R}$	Not applicable		%	
13	Motional Inductance	L_1	24	-	mH	
14	Motional Capacitance	C_1	Not applicable		fF	
15	Static Capacitance	C_o	Not applicable		pF	
16	Q Factor	Q	90 000	-	-	
17	Ratio of Unwanted: Response Resistance to Resonance Resistance or Response Impedance to Resonance Resistance	R_p/R $ Z_p /R$	2:1	-		In the frequency range: $f_r - 300\text{kHz}$ to $f_r + 300\text{kHz}$
18	Ageing	$\frac{\Delta f}{f}$	-3.0	+3.0	10^{-6}	After burn-in, per year
19	Lead Finish	-	2		-	

TABLE 1(a) - TYPE VARIANT DETAILED INFORMATION

TYPE VARIANT NO. 46

No.	Characteristics	Symbol	Limits		Unit	Remarks
			Min.	Max.		
1	Resonance Frequency	f_r	12.0		MHz	
2	Reference Temperature	T_o	+23	+27	°C	
3	Overtone Order	-	Fundamental			
4	Load Capacitance	C_L	∞		pF	
5	Rated Drive Level	P_o	0.1		mW	
6	Frequency Adjustment Tolerance	$\frac{\Delta f}{f}$	-10	+10	10^{-6}	At T_o °C
7	Resonance Resistance	R_r	-	20	Ω	At T_o °C
8	Frequency Variation with Temperature over T_{op}	$\frac{\Delta f}{f}$	-30	+30	10^{-6}	From frequency measured at T_o °C
9	Resistance Variation with Temperature over T_{op}	$\frac{\Delta R}{R}$	-10 or -1.5	+10 +1.5	% Ω	From resistance measured at T_o °C If $R < 10\Omega$
10	Operating Temperature Range	T_{op}	-40	+85	°C	
11	Frequency variation with Drive Level	$\frac{\Delta f}{f}$	Not applicable		10^{-6}	
12	Resistance variation with Drive Level	$\frac{\Delta R}{R}$	Not applicable		%	
13	Motional Inductance	L_1	8.0	-	mH	
14	Motional Capacitance	C_1	Not applicable		fF	
15	Static Capacitance	C_o	-	5.0	pF	
16	Q Factor	Q	80 000	-	-	
17	Ratio of Unwanted: Response Resistance to Resonance Resistance or Response Impedance to Resonance Resistance	R_p/R or $ Z_p /R$	2:1	-		In the frequency range: $f_r - 300\text{kHz}$ to $f_r + 300\text{kHz}$
18	Ageing	$\frac{\Delta f}{f}$	-3.0	+3.0	10^{-6}	After burn-in, per year
19	Lead Finish	-	2		-	



TABLE 1(a) - TYPE VARIANT DETAILED INFORMATION

TYPE VARIANT NO. 47

	Characteristics	Symbol	Limits		Unit	Remarks
			Min.	Max.		
1	Resonance Frequency	f_L	13.332		MHz	
2	Reference Temperature	T_o	+40		°C	
3	Overtone Order	-	Fundamental			
4	Load Capacitance	C_L	50		pF	
5	Rated Drive Level	P_o	0.1		mW	
6	Frequency Adjustment Tolerance	$\frac{\Delta f}{f}$	-5.0	+5.0	10^{-6}	At T_o °C
7	Resonance Resistance	R_L	-	13	Ω	Over T_{op} °C
8	Frequency Variation with Temperature over T_{op}	$\frac{\Delta f}{f}$	-8.0	+8.0	10^{-6}	From frequency measured at T_o °C
9	Resistance Variation with Temperature over T_{op}	$\frac{\Delta R}{R}$	Not applicable		%	
10	Operating Temperature Range	T_{op}	-20	+80	°C	
11	Frequency variation with Drive Level	$\frac{\Delta f}{f}$	Not applicable		10^{-6}	
12	Resistance variation with Drive Level	$\frac{\Delta R}{R}$	Not applicable		%	
13	Motional Inductance	L_1	8.0	-	mH	
14	Motional Capacitance	C_1	Not applicable		fF	
15	Static Capacitance	C_o	-	5.0	pF	
16	Q Factor	Q	50 000	-	-	
17	Ratio of Unwanted: Response Resistance to Resonance Resistance or Response Impedance to Resonance Resistance	R_p/R $ Z_p /R$	3:1	-		In the frequency range: $f_L - 1.0\text{MHz}$ to $f_L + 1.0\text{MHz}$
18	Ageing	$\frac{\Delta f}{f}$	-3.0	+3.0	10^{-6}	After burn-in, per year
19	Lead Finish	-	2		-	

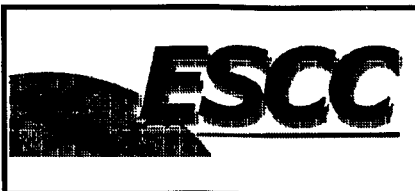

TABLE 1(a) - TYPE VARIANT DETAILED INFORMATION

TYPE VARIANT NO. 48

No.	Characteristics	Symbol	Limits		Unit	Remarks
			Min.	Max.		
1	Resonance Frequency	f_L	5.24288		MHz	
2	Reference Temperature	T_o	+ 60		°C	
3	Overtone Order	-	Fundamental			
4	Load Capacitance	C_L	22		pF	
5	Rated Drive Level	P_o	0.1		mW	
6	Frequency Adjustment Tolerance	$\frac{\Delta f}{f}$	-10	+ 10	10^{-6}	At T_o °C
7	Resonance Resistance	R_L	-	13	Ω	Over T_{op} °C
8	Frequency Variation with Temperature over T_{op}	$\frac{\Delta f}{f}$	-15	+ 15	10^{-6}	From frequency measured at T_o °C
9	Resistance Variation with Temperature over T_{op}	$\frac{\Delta R}{R}$	Not applicable		%	
10	Operating Temperature Range	T_{op}	-40	+ 85	°C	
11	Frequency variation with Drive Level	$\frac{\Delta f}{f}$	Not applicable		10^{-6}	
12	Resistance variation with Drive Level	$\frac{\Delta R}{R}$	Not applicable		%	
13	Motional Inductance	L_1	20	-	mH	
14	Motional Capacitance	C_1	Not applicable		fF	
15	Static Capacitance	C_o	-	5.0	pF	
16	Q Factor	Q	50 000	-	-	
17	Ratio of Unwanted: Response Resistance to Resonance Resistance or Response Impedance to Resonance Resistance	R_p/R $ Z_p /R$	3:1	-		In the frequency range: f_L -525kHz to f_L + 525kHz
18	Ageing	$\frac{\Delta f}{f}$	-3.0	+ 3.0	10^{-6}	After burn-in, per year
19	Lead Finish	-	2		-	

TABLE 1(a) - TYPE VARIANT DETAILED INFORMATION

TYPE VARIANT NO. 49

No.	Characteristics	Symbol	Limits		Unit	Remarks
			Min.	Max.		
1	Resonance Frequency	f_L	3.2		MHz	
2	Reference Temperature	T_o	+25	+29	°C	
3	Overtone Order	-	Fundamental			
4	Load Capacitance	C_L	30		pF	
5	Rated Drive Level	P_o	0.1		mW	
6	Frequency Adjustment Tolerance	$\frac{\Delta f}{f}$	-10	+10	10^{-6}	At T_o °C
7	Resonance Resistance	R_L	-	50	Ω	Over T_{op} °C
8	Frequency Variation with Temperature over T_{op}	$\frac{\Delta f}{f}$	-10	+10	10^{-6}	From frequency measured at T_o °C
9	Resistance Variation with Temperature over T_{op}	$\frac{\Delta R}{R}$	Not applicable		%	
10	Operating Temperature Range	T_{op}	-20	+70	°C	
11	Frequency variation with Drive Level	$\frac{\Delta f}{f}$	Not applicable		10^{-6}	
12	Resistance variation with Drive Level	$\frac{\Delta R}{R}$	Not applicable		%	
13	Motional Inductance	L_1	Not applicable		mH	
14	Motional Capacitance	C_1	Not applicable		fF	
15	Static Capacitance	C_o	-	7.0	pF	
16	Q Factor	Q	Not applicable		-	
17	Ratio of Unwanted: Response Resistance to Resonance Resistance or Response Impedance to Resonance Resistance	R_p/R or $ Z_p /R$	2:1	-		In the frequency range: $f_L - 200\text{kHz}$ to $f_L + 200\text{kHz}$
18	Ageing	$\frac{\Delta f}{f}$	-2.0	+2.0	10^{-6}	After burn-in and per year
19	Lead Finish	-	2		-	

TABLE 1(a) - TYPE VARIANT DETAILED INFORMATION

TYPE VARIANT NO. 50

No.	Characteristics	Symbol	Limits		Unit	Remarks
			Min.	Max.		
1	Resonance Frequency	f_L	4.0		MHz	
2	Reference Temperature	T_o	+23	+27	°C	
3	Overtone Order	-	Fundamental			
4	Load Capacitance	C_L	30		pF	
5	Rated Drive Level	P_o	0.1		mW	
6	Frequency Adjustment Tolerance	$\frac{\Delta f}{f}$	-10	+10	10^{-6}	At T_o °C
7	Resonance Resistance	R_L	-	25	Ω	Over T_{op} °C
8	Frequency Variation with Temperature over T_{op}	$\frac{\Delta f}{f}$	-12	+12	10^{-6}	From frequency measured at T_o °C
9	Resistance Variation with Temperature over T_{op}	$\frac{\Delta R}{R}$	Not applicable		%	
10	Operating Temperature Range	T_{op}	-40	+80	°C	
11	Frequency variation with Drive Level	$\frac{\Delta f}{f}$	Not applicable		10^{-6}	
12	Resistance variation with Drive Level	$\frac{\Delta R}{R}$	Not applicable		%	
13	Motional Inductance	L_1	230	-	mH	
14	Motional Capacitance	C_1	Not applicable		fF	
15	Static Capacitance	C_o	-	5.0	pF	
16	Q Factor	Q	125 000	-	-	
17	Ratio of Unwanted: Response Resistance to Resonance Resistance or Response Impedance to Resonance Resistance	R_p/R or $ Z_p /R$	2:1	-		In the frequency range: $f_L - 500\text{kHz}$ to $f_L + 500\text{kHz}$
18	Ageing	$\frac{\Delta f}{f}$	-3.0	+3.0	10^{-6}	After burn-in, per year
19	Lead Finish	-	2		-	

TABLE 1(a) - TYPE VARIANT DETAILED INFORMATION

TYPE VARIANT NO. 51

No.	Characteristics	Symbol	Limits		Unit	Remarks
			Min.	Max.		
1	Resonance Frequency	f_L	4.194304		MHz	At cut
2	Reference Temperature	T_0	+30		°C	
3	Overtone Order	-	Fundamental			
4	Load Capacitance	C_L	30		pF	
5	Rated Drive Level	P_0	0.1		mW	
6	Frequency Adjustment Tolerance	$\frac{\Delta f}{f}$	-10	+10	10^{-6}	At T_0 °C
7	Resonance Resistance	R_L	-	10	Ω	At T_0 °C
8	Frequency Variation with Temperature over T_{op}	$\frac{\Delta f}{f}$	-10	+10	10^{-6}	From frequency measured at T_0 °C
9	Resistance Variation with Temperature over T_{op}	$\frac{\Delta R}{R}$	-10	+10	%	From resistance measured at T_0 °C If $R < 10\Omega$
			-1.5	+1.5	Ω	
10	Operating Temperature Range	T_{op}	-10	+80	°C	
11	Frequency variation with Drive Level	$\frac{\Delta f}{f}$	Not applicable		10^{-6}	
12	Resistance variation with Drive Level	$\frac{\Delta R}{R}$	Not applicable		%	
13	Motional Inductance	L_1	Not applicable		mH	
14	Motional Capacitance	C_1	Not applicable		fF	
15	Static Capacitance	C_0	-	4.0	pF	
16	Q Factor	Q	200 000	-	-	
17	Ratio of Unwanted: Response Resistance to Resonance Resistance or Response Impedance to Resonance Resistance	R_p/R or $ Z_p /R$	2:1	-		In the frequency range: $f_L - 200\text{kHz}$ to $f_L + 200\text{kHz}$
18	Ageing	$\frac{\Delta f}{f}$	-10	+10	10^{-6}	Over 5 years of storage and 3000 hours operating
19	Lead Finish	-	2		-	

TABLE 1(a) - TYPE VARIANT DETAILED INFORMATION

TYPE VARIANT NO. 52

	Characteristics	Symbol	Limits		Unit	Remarks
			Min.	Max.		
1	Resonance Frequency	f_L	12.25		MHz	
2	Reference Temperature	T_0	+25		°C	
3	Overtone Order	-	Fundamental			
4	Load Capacitance	C_L	32		pF	
5	Rated Drive Level	P_0	0.1		mW	
6	Frequency Adjustment Tolerance	$\frac{\Delta f}{f}$	-10	+10	10^{-6}	At T_0 °C
7	Resonance Resistance	R_L	-	20	Ω	At T_0 °C
8	Frequency Variation with Temperature over T_{op}	$\frac{\Delta f}{f}$	-10	+10	10^{-6}	From frequency measured at T_0 °C
9	Resistance Variation with Temperature over T_{op}	$\frac{\Delta R}{R}$	-10	+10	%	From resistance measured at T_0 °C If $R < 10\Omega$
			-1.5	+1.5	Ω	
10	Operating Temperature Range	T_{op}	-20	+70	°C	
11	Frequency variation with Drive Level	$\frac{\Delta f}{f}$	Not applicable		10^{-6}	
12	Resistance variation with Drive Level	$\frac{\Delta R}{R}$	Not applicable		%	
13	Motional Inductance	L_1	12.6	15.4	mH	
14	Motional Capacitance	C_1	Not applicable		fF	
15	Static Capacitance	C_0	-	3.0	pF	
16	Q Factor	Q	100 000	-	-	
17	Ratio of Unwanted: Response Resistance to Resonance Resistance or Response Impedance to Resonance Resistance	R_p/R $ Z_{pl}/R$	25:1 4:1	- -		In the frequency range: $f_L \pm 30\text{kHz}$ $f_L - 50$ to $f_L - 500\text{kHz}$ and $f_L + 50$ to $f_L + 500\text{kHz}$
18	Ageing	$\frac{\Delta f}{f}$	-10	+10	10^{-6}	After burn-in, over 5 years
19	Lead Finish	-	2		-	



TABLE 1(a) - TYPE VARIANT DETAILED INFORMATION

TYPE VARIANT NO. 53

No.	Characteristics	Symbol	Limits		Unit	Remarks
			Min.	Max.		
1	Resonance Frequency	f_L	6.0		MHz	
2	Reference Temperature	T_0	+25		°C	
3	Overtone Order	-	Fundamental			
4	Load Capacitance	C_L	30		pF	
5	Rated Drive Level	P_0	0.1		mW	
6	Frequency Adjustment Tolerance	$\frac{\Delta f}{f}$	-5.0	+5.0	10^{-6}	At T_0 °C
7	Resonance Resistance	R_L	-	50	Ω	At T_0 °C
8	Frequency Variation with Temperature over T_{op}	$\frac{\Delta f}{f}$	-10	+10	10^{-6}	From frequency measured at T_0 °C
9	Resistance Variation with Temperature over T_{op}	$\frac{\Delta R}{R}$	-10 or -1.5	+10 +1.5	% Ω	From resistance measured at T_0 °C If $R < 10\Omega$
10	Operating Temperature Range	T_{op}	-40	+70	°C	
11	Frequency variation with Drive Level	$\frac{\Delta f}{f}$	Not applicable		10^{-6}	
12	Resistance variation with Drive Level	$\frac{\Delta R}{R}$	Not applicable		%	
13	Motional Inductance	L_1	Not applicable		mH	
14	Motional Capacitance	C_1	Not applicable		fF	
15	Static Capacitance	C_0	Not applicable		pF	
16	Q Factor	Q	600 000	-	-	
17	Ratio of Unwanted: Response Resistance to Resonance Resistance or Response Impedance to Resonance Resistance	R_p/R or $ Z_p /R$	Not applicable			
18	Ageing	$\frac{\Delta f}{f}$	-10	+10	10^{-6}	After burn-in, over 5 years
19	Lead Finish	-	2		-	

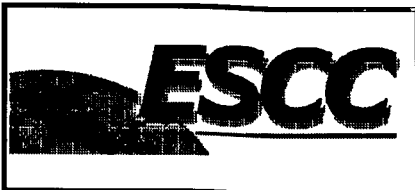

TABLE 1(a) - TYPE VARIANT DETAILED INFORMATION

TYPE VARIANT NO. 54

No.	Characteristics	Symbol	Limits		Unit	Remarks
			Min.	Max.		
1	Resonance Frequency	f_L	9.66 to 10.65		MHz	
2	Reference Temperature	T_o	+ 25		°C	
3	Overtone Order	-	Fundamental			
4	Load Capacitance	C_L	50		pF	
5	Rated Drive Level	P_o	0.1		mW	
6	Frequency Adjustment Tolerance	$\frac{\Delta f}{f}$	-10	+ 10	10^{-6}	At T_o °C
7	Resonance Resistance	R_L	-	15	Ω	Over T_{op} °C
8	Frequency Variation with Temperature over T_{op}	$\frac{\Delta f}{f}$	-20	+ 20	10^{-6}	From frequency measured at T_o °C
9	Resistance Variation with Temperature over T_{op}	$\frac{\Delta R}{R}$	Not applicable		%	
10	Operating Temperature Range	T_{op}	-20	+ 70	°C	
11	Frequency variation with Drive Level	$\frac{\Delta f}{f}$	Not applicable		10^{-6}	
12	Resistance variation with Drive Level	$\frac{\Delta R}{R}$	Not applicable		%	
13	Motional Inductance	L_1	Not applicable		mH	
14	Motional Capacitance	C_1	Not applicable		fF	
15	Static Capacitance	C_o	Not applicable		pF	
16	Q Factor	Q	Not applicable		-	
17	Ratio of Unwanted: Response Resistance to Resonance Resistance or Response Impedance to Resonance Resistance	R_p/R $ Z_p /R$	4:1	-		In the frequency range: f_L -500kHz to f_L + 500kHz
18	Ageing	$\frac{\Delta f}{f}$	-2.0	+ 2.0	10^{-6}	After burn-in and per year
19	Lead Finish	-	2		-	

TABLE 1(a) - TYPE VARIANT DETAILED INFORMATION

TYPE VARIANT NO. 55

No.	Characteristics	Symbol	Limits		Unit	Remarks
			Min.	Max.		
1	Resonance Frequency	f_L	4.096		MHz	
2	Reference Temperature	T_0	+25		°C	
3	Overtone Order	-	Fundamental			
4	Load Capacitance	C_L	50		pF	
5	Rated Drive Level	P_0	0.1		mW	
6	Frequency Adjustment Tolerance	$\frac{\Delta f}{f}$	-10	+10	10^{-6}	At T_0 °C
7	Resonance Resistance	R_L	-	20	Ω	Over T_{op} °C
8	Frequency Variation with Temperature over T_{op}	$\frac{\Delta f}{f}$	-10	+10	10^{-6}	From frequency measured at T_0 °C
9	Resistance Variation with Temperature over T_{op}	$\frac{\Delta R}{R}$	Not applicable		%	
10	Operating Temperature Range	T_{op}	-10	+80	°C	
11	Frequency variation with Drive Level	$\frac{\Delta f}{f}$	Not applicable		10^{-6}	
12	Resistance variation with Drive Level	$\frac{\Delta R}{R}$	Not applicable		%	
13	Motional Inductance	L_1	Not applicable		mH	
14	Motional Capacitance	C_1	Not applicable		fF	
15	Static Capacitance	C_0	-	5.0	pF	
16	Q Factor	Q	100 000	-	-	
17	Ratio of Unwanted: Response Resistance to Resonance Resistance or Response Impedance to Resonance Resistance	R_p/R or $ Z_{pl}/R$	3:1	-		In the frequency range: $f_L - 200\text{kHz}$ to $f_L + 200\text{kHz}$
18	Ageing	$\frac{\Delta f}{f}$	Not applicable		10^{-6}	
19	Lead Finish	-	2		-	



TABLE 1(a) - TYPE VARIANT DETAILED INFORMATION

TYPE VARIANT NO. 56

No.	Characteristics	Symbol	Limits		Unit	Remarks
			Min.	Max.		
1	Resonance Frequency	f_L	4.194304		MHz	
2	Reference Temperature	T_0	+ 60		°C	
3	Overtone Order	-	Fundamental			
4	Load Capacitance	C_L	22		pF	
5	Rated Drive Level	P_0	0.1		mW	
6	Frequency Adjustment Tolerance	$\frac{\Delta f}{f}$	-10	+ 10	10^{-6}	At T_0 °C
7	Resonance Resistance	R_L	-	13	Ω	Over T_{op} °C
8	Frequency Variation with Temperature over T_{op}	$\frac{\Delta f}{f}$	-15	+ 15	10^{-6}	From frequency measured at T_0 °C
9	Resistance Variation with Temperature over T_{op}	$\frac{\Delta R}{R}$	Not applicable		%	
10	Operating Temperature Range	T_{op}	-20	+ 70	°C	
11	Frequency variation with Drive Level	$\frac{\Delta f}{f}$	Not applicable		10^{-6}	
12	Resistance variation with Drive Level	$\frac{\Delta R}{R}$	Not applicable		%	
13	Motional Inductance	L_1	Not applicable		mH	
14	Motional Capacitance	C_1	Not applicable		fF	
15	Static Capacitance	C_0	Not applicable		pF	
16	Q Factor	Q	50 000	-	-	
17	Ratio of Unwanted: Response Resistance to Resonance Resistance or Response Impedance to Resonance Resistance	R_p/R or $ Z_p /R$	3:1	-		In the frequency range: $f_L - 200\text{kHz}$ to $f_L + 200\text{kHz}$
18	Ageing	$\frac{\Delta f}{f}$	-3.0	+ 3.0	10^{-6}	After burn-in and per year
19	Lead Finish	-	2		-	

TABLE 1(a) - TYPE VARIANT DETAILED INFORMATION

TYPE VARIANT NO. 57

	Characteristics	Symbol	Limits		Unit	Remarks
			Min.	Max.		
1	Resonance Frequency	f_L	5.24288		MHz	
2	Reference Temperature	T_0	+ 60		°C	
3	Overtone Order	-	Fundamental			
4	Load Capacitance	C_L	22		pF	
5	Rated Drive Level	P_0	0.1		mW	
6	Frequency Adjustment Tolerance	$\frac{\Delta f}{f}$	-10	+ 10	10^{-6}	At T_0 °C
7	Resonance Resistance	R_L	-	13	Ω	Over T_{op} °C
8	Frequency Variation with Temperature over T_{op}	$\frac{\Delta f}{f}$	-15	+ 15	10^{-6}	From frequency measured at T_0 °C
9	Resistance Variation with Temperature over T_{op}	$\frac{\Delta R}{R}$	Not applicable		%	
10	Operating Temperature Range	T_{op}	-20	+ 70	°C	
11	Frequency variation with Drive Level	$\frac{\Delta f}{f}$	Not applicable		10^{-6}	
12	Resistance variation with Drive Level	$\frac{\Delta R}{R}$	Not applicable		%	
13	Motional Inductance	L_1	Not applicable		mH	
14	Motional Capacitance	C_1	Not applicable		fF	
15	Static Capacitance	C_0	Not applicable		pF	
16	Q Factor	Q	50 000	-	-	
17	Ratio of Unwanted: Response Resistance to Resonance Resistance or Response Impedance to Resonance Resistance	R_p/R or $ Z_p /R$	3:1	-		In the frequency range: f_L -200kHz to f_L + 200kHz
18	Ageing	$\frac{\Delta f}{f}$	-3.0	+ 3.0	10^{-6}	After burn-in and per year
19	Lead Finish	-	2		-	

TABLE 1(a) - TYPE VARIANT DETAILED INFORMATION

TYPE VARIANT NO. 58

No.	Characteristics	Symbol	Limits		Unit	Remarks
			Min.	Max.		
1	Resonance Frequency	f_L	8.0		MHz	
2	Reference Temperature	T_o	+60		°C	
3	Overtone Order	-	Fundamental			
4	Load Capacitance	C_L	22		pF	
5	Rated Drive Level	P_o	0.1		mW	
6	Frequency Adjustment Tolerance	$\frac{\Delta f}{f}$	-10	+10	10^{-6}	At T_o °C
7	Resonance Resistance	R_L	-	13	Ω	Over T_{op} °C
8	Frequency Variation with Temperature over T_{op}	$\frac{\Delta f}{f}$	-15	+15	10^{-6}	From frequency measured at T_o °C
9	Resistance Variation with Temperature over T_{op}	$\frac{\Delta R}{R}$	Not applicable		%	
10	Operating Temperature Range	T_{op}	-20	+70	°C	
11	Frequency variation with Drive Level	$\frac{\Delta f}{f}$	Not applicable		10^{-6}	
12	Resistance variation with Drive Level	$\frac{\Delta R}{R}$	Not applicable		%	
13	Motional Inductance	L_1	Not applicable		mH	
14	Motional Capacitance	C_1	Not applicable		fF	
15	Static Capacitance	C_o	Not applicable		pF	
16	Q Factor	Q	50 000	-	-	
17	Ratio of Unwanted: Response Resistance to Resonance Resistance or Response Impedance to Resonance Resistance	R_p/R $ Z_p /R$	3:1	-		In the frequency range: f_L -200kHz to f_L +200kHz
18	Ageing	$\frac{\Delta f}{f}$	-3.0	+3.0	10^{-6}	After burn-in and per year
19	Lead Finish	-	2		-	

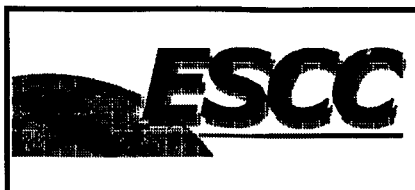

TABLE 1(a) - TYPE VARIANT DETAILED INFORMATION

TYPE VARIANT NO. 59

No.	Characteristics	Symbol	Limits		Unit	Remarks
			Min.	Max.		
1	Resonance Frequency	f_L	13.332		MHz	
2	Reference Temperature	T_o	+ 40		°C	
3	Overtone Order	-	Fundamental			
4	Load Capacitance	C_L	50		pF	
5	Rated Drive Level	P_o	0.1		mW	
6	Frequency Adjustment Tolerance	$\frac{\Delta f}{f}$	-10	+ 10	10^{-6}	At T_o °C
7	Resonance Resistance	R_L	-	13	Ω	Over T_{op} °C
8	Frequency Variation with Temperature over T_{op}	$\frac{\Delta f}{f}$	-15	+ 15	10^{-6}	From frequency measured at T_o °C
9	Resistance Variation with Temperature over T_{op}	$\frac{\Delta R}{R}$	Not applicable		%	
10	Operating Temperature Range	T_{op}	-20	+ 80	°C	
11	Frequency variation with Drive Level	$\frac{\Delta f}{f}$	Not applicable		10^{-6}	
12	Resistance variation with Drive Level	$\frac{\Delta R}{R}$	Not applicable		%	
13	Motional Inductance	L_1	Not applicable		mH	
14	Motional Capacitance	C_1	Not applicable		fF	
15	Static Capacitance	C_o	Not applicable		pF	
16	Q Factor	Q	50 000	-	-	
17	Ratio of Unwanted: Response Resistance to Resonance Resistance or Response Impedance to Resonance Resistance	R_p/R or $ Z_p /R$	3:1	-		In the frequency range: f_L -200kHz to f_L + 200kHz
18	Ageing	$\frac{\Delta f}{f}$	-3.0	+ 3.0	10^{-6}	After burn-in and per year
19	Lead Finish	-	2		-	

TABLE 1(a) - TYPE VARIANT DETAILED INFORMATION

TYPE VARIANT NO. 60

No.	Characteristics	Symbol	Limits		Unit	Remarks
			Min.	Max.		
1	Resonance Frequency	f_L	4.194304		MHz	
2	Reference Temperature	T_0	+25		°C	
3	Overtone Order	-	Fundamental			
4	Load Capacitance	C_L	30		pF	
5	Rated Drive Level	P_0	0.1		mW	
6	Frequency Adjustment Tolerance	$\frac{\Delta f}{f}$	-10	+10	10^{-6}	At T_0 °C
7	Resonance Resistance	R_L	-	40	Ω	At T_0 °C
8	Frequency Variation with Temperature over T_{op}	$\frac{\Delta f}{f}$	-10	+10	10^{-6}	From frequency measured at T_0 °C
9	Resistance Variation with Temperature over T_{op}	$\frac{\Delta R}{R}$	-10	+10	%	From resistance measured at T_0 °C If $R < 10\Omega$
			or	+1.5	Ω	
10	Operating Temperature Range	T_{op}	-30	+70	°C	
11	Frequency variation with Drive Level	$\frac{\Delta f}{f}$	Not applicable		10^{-6}	
12	Resistance variation with Drive Level	$\frac{\Delta R}{R}$	Not applicable		%	
13	Motional Inductance	L_1	120	-	mH	
14	Motional Capacitance	C_1	-	-	fF	
15	Static Capacitance	C_0	-	4.0	pF	
16	Q Factor	Q	300 000	-	-	
17	Ratio of Unwanted: Response Resistance to Resonance Resistance or Response Impedance to Resonance Resistance	R_p/R or $ Z_p /R$	Not applicable			
18	Ageing	$\frac{\Delta f}{f}$	-3.0	+3.0	10^{-6}	After burn-in, over 5 years
19	Lead Finish	-	2		-	

TABLE 1(a) - TYPE VARIANT DETAILED INFORMATION

TYPE VARIANT NO. 61

No.	Characteristics	Symbol	Limits		Unit	Remarks
			Min.	Max.		
1	Resonance Frequency	f_L	12.25		MHz	
2	Reference Temperature	T_0	+ 25		°C	
3	Overtone Order	-	Fundamental			
4	Load Capacitance	C_L	32		pF	
5	Rated Drive Level	P_0	0.1		mW	
6	Frequency Adjustment Tolerance	$\frac{\Delta f}{f}$	-8.0	+ 8.0	10^{-6}	At T_0 °C
7	Resonance Resistance	R_L	-	100	Ω	At T_0 °C
8	Frequency Variation with Temperature over T_{op}	$\frac{\Delta f}{f}$	-10	+ 10	10^{-6}	From frequency measured at T_0 °C
9	Resistance Variation with Temperature over T_{op}	$\frac{\Delta R}{R}$	-10	+ 10	%	From resistance measured at T_0 °C If $R < 10\Omega$
			-1.5	+ 1.5	Ω	
10	Operating Temperature Range	T_{op}	-20	+ 70	°C	
11	Frequency variation with Drive Level	$\frac{\Delta f}{f}$	Not applicable		10^{-6}	
12	Resistance variation with Drive Level	$\frac{\Delta R}{R}$	Not applicable		%	
13	Motional Inductance	L_1	4.5	5.5	mH	
14	Motional Capacitance	C_1	-	-	fF	
15	Static Capacitance	C_0	-	3.0	pF	
16	Q Factor	Q	30 000	-	-	
17	Unwanted Response Resistance	R_p	25	-	k Ω	In the frequency range: $f_L - 30\text{kHz}$ to $f_L + 30\text{kHz}$
18	Ageing	$\frac{\Delta f}{f}$	-10	+ 10	10^{-6}	After burn-in, over 5 years
19	Lead Finish	-	2		-	



TABLE 1(a) - TYPE VARIANT DETAILED INFORMATION

TYPE VARIANT NO. 62

	Characteristics	Symbol	Limits		Unit	Remarks
			Min.	Max.		
1	Resonance Frequency	f_r	4.096		MHz	
2	Reference Temperature	T_o	+25		°C	
3	Overtone Order	-	Fundamental			
4	Load Capacitance	C_L	∞		pF	
5	Rated Drive Level	P_o	0.1		mW	
6	Frequency Adjustment Tolerance	$\frac{\Delta f}{f}$	-10	+10	10^{-6}	At T_o °C
7	Resonance Resistance	R_r	-	50	Ω	Over T_{op} °C
8	Frequency Variation with Temperature over T_{op}	$\frac{\Delta f}{f}$	-15	+15	10^{-6}	From frequency measured at T_o °C
9	Resistance Variation with Temperature over T_{op}	$\frac{\Delta R}{R}$	Not applicable		%	
10	Operating Temperature Range	T_{op}	-30	+80	°C	
11	Frequency variation with Drive Level	$\frac{\Delta f}{f}$	Not applicable		10^{-6}	
12	Resistance variation with Drive Level	$\frac{\Delta R}{R}$	Not applicable		%	
13	Motional Inductance	L_1	Not applicable		mH	
14	Motional Capacitance	C_1	Not applicable		fF	
15	Static Capacitance	C_o	Not applicable		pF	
16	Q Factor	Q	75 000	-	-	
17	Ratio of Unwanted: Response Resistance to Resonance Resistance or Response Impedance to Resonance Resistance	R_p/R or $ Z_p /R$	3:1	-		In the frequency range: $f_r - 200\text{kHz}$ to $f_r + 200\text{kHz}$
18	Ageing	$\frac{\Delta f}{f}$	-3.0	+3.0	10^{-6}	After burn-in and per year
19	Lead Finish	-	2		-	



TABLE 1(a) - TYPE VARIANT DETAILED INFORMATION

TYPE VARIANT NO. 63

No.	Characteristics	Symbol	Limits		Unit	Remarks
			Min.	Max.		
1	Resonance Frequency	f_r	4.194304		MHz	
2	Reference Temperature	T_o	+ 25		°C	
3	Overtone Order	-	Fundamental			
4	Load Capacitance	C_L	∞		pF	
5	Rated Drive Level	P_o	0.1		mW	
6	Frequency Adjustment Tolerance	$\frac{\Delta f}{f}$	-10	+ 10	10^{-6}	At T_o °C
7	Resonance Resistance	R_r	-	50	Ω	Over T_{op} °C
8	Frequency Variation with Temperature over T_{op}	$\frac{\Delta f}{f}$	-15	+ 15	10^{-6}	From frequency measured at T_o °C
9	Resistance Variation with Temperature over T_{op}	$\frac{\Delta R}{R}$	Not applicable		%	
10	Operating Temperature Range	T_{op}	-30	+ 80	°C	
11	Frequency variation with Drive Level	$\frac{\Delta f}{f}$	Not applicable		10^{-6}	
12	Resistance variation with Drive Level	$\frac{\Delta R}{R}$	Not applicable		%	
13	Motional Inductance	L_1	Not applicable		mH	
14	Motional Capacitance	C_1	Not applicable		fF	
15	Static Capacitance	C_o	Not applicable		pF	
16	Q Factor	Q	75 000	-	-	
17	Ratio of Unwanted: Response Resistance to Resonance Resistance or Response Impedance to Resonance Resistance	R_p/R $ Z_p /R$	3:1	-		In the frequency range: $f_r -10\%$ to $f_r + 10\%$
18	Ageing	$\frac{\Delta f}{f}$	-3.0	+ 3.0	10^{-6}	After burn-in and per year
19	Lead Finish	-	2		-	

TABLE 1(a) - TYPE VARIANT DETAILED INFORMATION

TYPE VARIANT NO. 64

No.	Characteristics	Symbol	Limits		Unit	Remarks
			Min.	Max.		
1	Resonance Frequency	f_L	5.24288		MHz	
2	Reference Temperature	T_o	+20	+30	°C	
3	Overtone Order	-	Fundamental			
4	Load Capacitance	C_L	22		pF	
5	Rated Drive Level	P_o	0.1		mW	
6	Frequency Adjustment Tolerance	$\frac{\Delta f}{f}$	-10	+10	10^{-6}	At T_o °C
7	Resonance Resistance	R_L	-	13	Ω	Over T_{op} °C
8	Frequency Variation with Temperature over T_{op}	$\frac{\Delta f}{f}$	-15	+15	10^{-6}	From frequency measured at T_o °C
9	Resistance Variation with Temperature over T_{op}	$\frac{\Delta R}{R}$	Not applicable		%	
10	Operating Temperature Range	T_{op}	-20	+70	°C	
11	Frequency variation with Drive Level	$\frac{\Delta f}{f}$	Not applicable		10^{-6}	
12	Resistance variation with Drive Level	$\frac{\Delta R}{R}$	Not applicable		%	
13	Motional Inductance	L_1	Not applicable		mH	
14	Motional Capacitance	C_1	Not applicable		fF	
15	Static Capacitance	C_o	Not applicable		pF	
16	Q Factor	Q	50 000	-	-	
17	Ratio of Unwanted: Response Resistance to Resonance Resistance or Response Impedance to Resonance Resistance	R_p/R $ Z_p /R$	3:1	-		In the frequency range: $f_L - 200\text{kHz}$ to $f_L + 200\text{kHz}$
18	Ageing	$\frac{\Delta f}{f}$	-3.0	+3.0	10^{-6}	After burn-in and per year
19	Lead Finish	-	2		-	

TABLE 1(a) - TYPE VARIANT DETAILED INFORMATION

TYPE VARIANT NO. 65

No.	Characteristics	Symbol	Limits		Unit	Remarks
			Min.	Max.		
1	Resonance Frequency	f_L	12.25		MHz	
2	Reference Temperature	T_0	+25		°C	
3	Overtone Order	-	Fundamental			
4	Load Capacitance	C_L	32		pF	
5	Rated Drive Level	P_0	0.1		mW	
6	Frequency Adjustment Tolerance	$\frac{\Delta f}{f}$	-8.0	+8.0	10^{-6}	At T_0 °C
7	Resonance Resistance	R_L	-	10	Ω	At T_0 °C
8	Frequency Variation with Temperature over T_{op}	$\frac{\Delta f}{f}$	-10	+10	10^{-6}	From frequency measured at T_0 °C
9	Resistance Variation with Temperature over T_{op}	$\frac{\Delta R}{R}$	-50	+50	%	From resistance measured at T_0 °C
10	Operating Temperature Range	T_{op}	-20	+70	°C	
11	Frequency variation with Drive Level	$\frac{\Delta f}{f}$	Not applicable		10^{-6}	
12	Resistance variation with Drive Level	$\frac{\Delta R}{R}$	Not applicable		%	
13	Motional Inductance	L_1	9.0	11	mH	
14	Motional Capacitance	C_1	Not applicable		fF	
15	Static Capacitance	C_0	-	3.0	pF	
16	Q Factor	Q	80 000	-	-	
17	Ratio of Unwanted: Response Resistance to Resonance Resistance or Response Impedance to Resonance Resistance	R_p/R or $ Z_p /R$	10:1	-		In the frequency range: $f_L - 300\text{kHz}$ to $f_L + 200\text{kHz}$
18	Ageing	$\frac{\Delta f}{f}$	-10	+10	10^{-6}	After burn-in, over 5 years
19	Lead Finish	-	2		-	

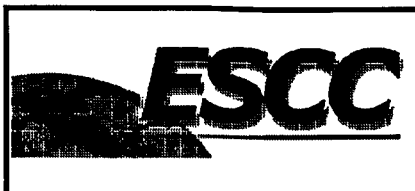

TABLE 1(a) - TYPE VARIANT DETAILED INFORMATION

TYPE VARIANT NO. 66

No.	Characteristics	Symbol	Limits		Unit	Remarks
			Min.	Max.		
1	Resonance Frequency	f_L	5.0		MHz	
2	Reference Temperature	T_0	+25		°C	
3	Overtone Order	-	Fundamental			
4	Load Capacitance	C_L	20	40	pF	
5	Rated Drive Level	P_0	0.1		mW	
6	Frequency Adjustment Tolerance	$\frac{\Delta f}{f}$	-10	+10	10^{-6}	At T_0 °C
7	Resonance Resistance	R_L	-	10	Ω	At T_0 °C
8	Frequency Variation with Temperature over T_{op}	$\frac{\Delta f}{f}$	-2.5	+2.5	10^{-6}	From frequency measured at T_0 °C
9	Resistance Variation with Temperature over T_{op}	$\frac{\Delta R}{R}$	-10 or -1.5	+10 +1.5	% Ω	From resistance measured at T_0 °C If $R < 10\Omega$
10	Operating Temperature Range	T_{op}	-10	+40	°C	
11	Frequency variation with Drive Level	$\frac{\Delta f}{f}$	Not applicable		10^{-6}	
12	Resistance variation with Drive Level	$\frac{\Delta R}{R}$	Not applicable		%	
13	Motional Inductance	L_1	70	120	mH	
14	Motional Capacitance	C_1	Not applicable		fF	
15	Static Capacitance	C_0	3.0	5.0	pF	
16	Q Factor	Q	350 000	-	-	
17	Ratio of Unwanted: Response Resistance to Resonance Resistance or Response Impedance to Resonance Resistance	R_p/R or $ Z_p /R$	Not applicable			
18	Ageing	$\frac{\Delta f}{f}$	-65	+65	10^{-6}	After burn-in, per year
19	Lead Finish	-	2		-	

TABLE 1(a) - TYPE VARIANT DETAILED INFORMATION

TYPE VARIANT NO. 67

	Characteristics	Symbol	Limits		Unit	Remarks
			Min.	Max.		
1	Resonance Frequency	f_L	5.0		MHz	
2	Reference Temperature	T_0	+25	+29	°C	
3	Overtone Order	-	Fundamental			
4	Load Capacitance	C_L	30		pF	
5	Rated Drive Level	P_0	0.1		mW	
6	Frequency Adjustment Tolerance	$\frac{\Delta f}{f}$	-10	+10	10^{-6}	At T_0 °C
7	Resonance Resistance	R_L	-	30	Ω	At T_0 °C
8	Frequency Variation with Temperature over T_{op}	$\frac{\Delta f}{f}$	-10	+10	10^{-6}	From frequency measured at T_0 °C
9	Resistance Variation with Temperature over T_{op}	$\frac{\Delta R}{R}$	-10 or -1.5	+10 +1.5	% Ω	From resistance measured at T_0 °C If $R < 10\Omega$
10	Operating Temperature Range	T_{op}	-20	+70	°C	
11	Frequency variation with Drive Level	$\frac{\Delta f}{f}$	Not applicable		10^{-6}	
12	Resistance variation with Drive Level	$\frac{\Delta R}{R}$	Not applicable		%	
13	Motional Inductance	L_1	Not applicable		mH	
14	Motional Capacitance	C_1	Not applicable		fF	
15	Static Capacitance	C_0	Not applicable		pF	
16	Q Factor	Q	200 000	-	-	
17	Ratio of Unwanted: Response Resistance to Resonance Resistance or Response Impedance to Resonance Resistance	R_p/R $ Z_p /R$	2:1	-		In the frequency range: $f_L - 200\text{kHz}$ to $f_L + 200\text{kHz}$
18	Ageing	$\frac{\Delta f}{f}$	-3.0	+3.0	10^{-6}	After burn-in, per year
19	Lead Finish	-	2		-	

TABLE 1(a) - TYPE VARIANT DETAILED INFORMATION

TYPE VARIANT NO. 68

No.	Characteristics	Symbol	Limits		Unit	Remarks
			Min.	Max.		
1	Resonance Frequency	f_L	12.0		MHz	
2	Reference Temperature	T_o	+ 25	+ 29	°C	
3	Overtone Order	-	Fundamental			
4	Load Capacitance	C_L	30		pF	
5	Rated Drive Level	P_o	0.1		mW	
6	Frequency Adjustment Tolerance	$\frac{\Delta f}{f}$	-10	+ 10	10^{-6}	At T_o °C
7	Resonance Resistance	R_L	-	30	Ω	At T_o °C
8	Frequency Variation with Temperature over T_{op}	$\frac{\Delta f}{f}$	-10	+ 10	10^{-6}	From frequency measured at T_o °C
9	Resistance Variation with Temperature over T_{op}	$\frac{\Delta R}{R}$	-10 or -1.5	+ 10 + 1.5	% Ω	From resistance measured at T_o °C If $R < 10\Omega$
10	Operating Temperature Range	T_{op}	-20	+ 70	°C	
11	Frequency variation with Drive Level	$\frac{\Delta f}{f}$	Not applicable		10^{-6}	
12	Resistance variation with Drive Level	$\frac{\Delta R}{R}$	Not applicable		%	
13	Motional Inductance	L_1	Not applicable		mH	
14	Motional Capacitance	C_1	Not applicable		fF	
15	Static Capacitance	C_o	Not applicable		pF	
16	Q Factor	Q	80 000	-	-	
17	Ratio of Unwanted: Response Resistance to Resonance Resistance or Response Impedance to Resonance Resistance	R_p/R or $ Z_p /R$	2:1	-		In the frequency range: $f_L - 200\text{kHz}$ to $f_L + 200\text{kHz}$
18	Ageing	$\frac{\Delta f}{f}$	-3.0	+ 3.0	10^{-6}	After burn-in, per year
19	Lead Finish	-	2		-	



TABLE 1(a) - TYPE VARIANT DETAILED INFORMATION

TYPE VARIANT NO. 69

No.	Characteristics	Symbol	Limits		Unit	Remarks
			Min.	Max.		
1	Resonance Frequency	f_r	11.0		MHz	
2	Reference Temperature	T_0	+23	+27	°C	
3	Overtone Order	-	Fundamental			
4	Load Capacitance	C_L	∞		pF	
5	Rated Drive Level	P_0	0.1		mW	
6	Frequency Adjustment Tolerance	$\frac{\Delta f}{f}$	-10	+10	10^{-6}	At T_0 °C
7	Resonance Resistance	R_r	-	15	Ω	At T_0 °C
8	Frequency Variation with Temperature over T_{op}	$\frac{\Delta f}{f}$	-12	+12	10^{-6}	From frequency measured at T_0 °C
9	Resistance Variation with Temperature over T_{op}	$\frac{\Delta R}{R}$	-10	+10	%	From resistance measured at T_0 °C If $R < 10\Omega$
			-1.5	+1.5	Ω	
10	Operating Temperature Range	T_{op}	-20	+80	°C	
11	Frequency variation with Drive Level	$\frac{\Delta f}{f}$	Not applicable		10^{-6}	
12	Resistance variation with Drive Level	$\frac{\Delta R}{R}$	Not applicable		%	
13	Motional Inductance	L_1	11.2	16.8	mH	
14	Motional Capacitance	C_1	Not applicable		fF	
15	Static Capacitance	C_0	-	7.0	pF	
16	Q Factor	Q	50 000	-	-	
17	Ratio of Unwanted: Response Resistance to Resonance Resistance or Response Impedance to Resonance Resistance	R_p/R or $ Z_p /R$	2:1	-		In the frequency range: $f_r - 200\text{kHz}$ to $f_r + 200\text{kHz}$
18	Ageing	$\frac{\Delta f}{f}$	-3.0	+3.0	10^{-6}	After burn-in, per year
19	Lead Finish	-	2		-	



TABLE 1(a) - TYPE VARIANT DETAILED INFORMATION

TYPE VARIANT NO. 70

No.	Characteristics	Symbol	Limits		Unit	Remarks
			Min.	Max.		
1	Resonance Frequency	f_L	12.0		MHz	Swept
2	Reference Temperature	T_0	+23	+27	°C	
3	Overtone Order	-	Fundamental			
4	Load Capacitance	C_L	31.7	32.3	pF	
5	Rated Drive Level	P_0	0.1		mW	
6	Frequency Adjustment Tolerance	$\frac{\Delta f}{f}$	-10	+10	10^{-6}	At T_0 °C
7	Resonance Resistance	R_L	-	20	Ω	At T_0 °C
8	Frequency Variation with Temperature over T_{op}	$\frac{\Delta f}{f}$	-15	+15	10^{-6}	From frequency measured at T_0 °C
9	Resistance Variation with Temperature over T_{op}	$\frac{\Delta R}{R}$	-20	+20	%	From resistance measured at T_0 °C
			-2.0	+2.0	Ω	
			whichever is greater			
10	Operating Temperature Range	T_{op}	-25	+90	°C	
11	Frequency variation with Drive Level	$\frac{\Delta f}{f}$	Not applicable		10^{-6}	
12	Resistance variation with Drive Level	$\frac{\Delta R}{R}$	Not applicable		%	
13	Motional Inductance	L_1	7.0	-	mH	
14	Motional Capacitance	C_1	Not applicable		fF	
15	Static Capacitance	C_0	Not applicable		pF	
16	Q Factor	Q	90 000	-	-	
17	Ratio of Unwanted: Response Resistance to Resonance Resistance or Response Impedance to Resonance Resistance	R_p/R or $ Z_p /R$	2:1	-		In the frequency range: $f_L - 300\text{kHz}$ to $f_L + 300\text{kHz}$
18	Ageing	$\frac{\Delta f}{f}$	-3.0	+3.0	10^{-6}	After burn-in, per year over 3 years
19	Lead Finish	-	2		-	



TABLE 1(a) - TYPE VARIANT DETAILED INFORMATION

TYPE VARIANT NO. 71

No.	Characteristics	Symbol	Limits		Unit	Remarks
			Min.	Max.		
1	Resonance Frequency	f_L	4.9152		MHz	
2	Reference Temperature	T_0	+23	+27	°C	
3	Overtone Order	-	Fundamental			
4	Load Capacitance	C_L	30		pF	
5	Rated Drive Level	P_0	0.1		mW	
6	Frequency Adjustment Tolerance	$\frac{\Delta f}{f}$	-10	+10	10 ⁻⁶	At T_0 °C
7	Resonance Resistance	R_L	-	40	Ω	At T_0 °C
8	Frequency Variation with Temperature over T_{op}	$\frac{\Delta f}{f}$	-20	+20	10 ⁻⁶	From frequency measured at T_0 °C
9	Resistance Variation with Temperature over T_{op}	$\frac{\Delta R}{R}$	-10 or -2.0	+10 +2.0	% Ω	From resistance measured at T_0 °C
10	Operating Temperature Range	T_{op}	-20	+60	°C	
11	Frequency variation with Drive Level	$\frac{\Delta f}{f}$	Not applicable		10 ⁻⁶	
12	Resistance variation with Drive Level	$\frac{\Delta R}{R}$	Not applicable		%	
13	Motional Inductance	L_1	Not applicable		mH	
14	Motional Capacitance	C_1	Not applicable		fF	
15	Static Capacitance	C_0	-	7.0	pF	
16	Q Factor	Q	250 000	-	-	
17	Ratio of Unwanted: Response Resistance to Resonance Resistance or Response Impedance to Resonance Resistance	R_p/R or $ Z_p /R$	2:1	-		In the frequency range: f_L -200kHz to f_L +200kHz
18	Ageing	$\frac{\Delta f}{f}$	-2.0	+2.0	10 ⁻⁶	Per year after burn-in
19	Lead Finish	-	2		-	

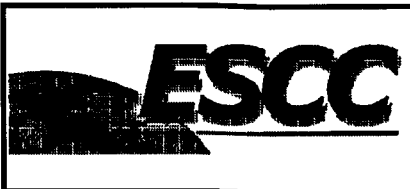

TABLE 1(a) - TYPE VARIANT DETAILED INFORMATION

TYPE VARIANT NO. 72

No.	Characteristics	Symbol	Limits		Unit	Remarks
			Min.	Max.		
1	Resonance Frequency	f_L	15.0		MHz	
2	Reference Temperature	T_0	+23	+27	°C	
3	Overtone Order	-	Fundamental			
4	Load Capacitance	C_L	30		pF	
5	Rated Drive Level	P_0	0.1		mW	
6	Frequency Adjustment Tolerance	$\frac{\Delta f}{f}$	-10	+10	10^{-6}	At T_0 °C
7	Resonance Resistance	R_L	-	20	Ω	Over T_{op} °C
8	Frequency Variation with Temperature over T_{op}	$\frac{\Delta f}{f}$	-30	+30	10^{-6}	From frequency measured at T_0 °C
9	Resistance Variation with Temperature over T_{op}	$\frac{\Delta R}{R}$	Not applicable		%	
10	Operating Temperature Range	T_{op}	-40	+85	°C	
11	Frequency variation with Drive Level	$\frac{\Delta f}{f}$	Not applicable		10^{-6}	
12	Resistance variation with Drive Level	$\frac{\Delta R}{R}$	Not applicable		%	
13	Motional Inductance	L_1	Not applicable		mH	
14	Motional Capacitance	C_1	Not applicable		fF	
15	Static Capacitance	C_0	-	7.0	pF	
16	Q Factor	Q	65 000	-	-	
17	Ratio of Unwanted: Response Resistance to Resonance Resistance or Response Impedance to Resonance Resistance	R_p/R or $ Z_p /R$	2:1	-		In the frequency range: $f_L - 200\text{kHz}$ to $f_L + 200\text{kHz}$
18	Ageing	$\frac{\Delta f}{f}$	-1.0	+1.0	10^{-6}	Per year after burn-in
19	Lead Finish	-	2		-	



TABLE 1(a) - TYPE VARIANT DETAILED INFORMATION

TYPE VARIANT NO. 73

No.	Characteristics	Symbol	Limits		Unit	Remarks
			Min.	Max.		
1	Resonance Frequency	f_L	7.5		MHz	
2	Reference Temperature	T_o	+23	+27	°C	
3	Overtone Order	-	Fundamental			
4	Load Capacitance	C_L	30		pF	
5	Rated Drive Level	P_o	0.1		mW	
6	Frequency Adjustment Tolerance	$\frac{\Delta f}{f}$	-50	+50	10^{-6}	At T_o °C
7	Resonance Resistance	R_L	-	30	Ω	At T_o °C
8	Frequency Variation with Temperature over T_{op}	$\frac{\Delta f}{f}$	-50	+50	10^{-6}	From frequency measured at T_o °C
9	Resistance Variation with Temperature over T_{op}	$\frac{\Delta R}{R}$	-10	+10	%	From resistance measured at T_o °C If $R < 10\Omega$
			-1.5	+1.5	Ω	
10	Operating Temperature Range	T_{op}	-20	+50	°C	
11	Frequency variation with Drive Level	$\frac{\Delta f}{f}$	Not applicable		10^{-6}	
12	Resistance variation with Drive Level	$\frac{\Delta R}{R}$	Not applicable		%	
13	Motional Inductance	L_1	Not applicable		mH	
14	Motional Capacitance	C_1	Not applicable		fF	
15	Static Capacitance	C_o	-	5.0	pF	
16	Q Factor	Q	80 000	-	-	
17	Ratio of Unwanted: Response Resistance to Resonance Resistance or Response Impedance to Resonance Resistance	R_p/R or $ Z_p /R$	2:1	-		In the frequency range: $f_L - 200\text{kHz}$ to $f_L + 200\text{kHz}$
18	Ageing	$\frac{\Delta f}{f}$	-10	+10	10^{-6}	Over 10 years
19	Lead Finish	-	2		-	

TABLE 1(a) - TYPE VARIANT DETAILED INFORMATION

TYPE VARIANT NO. 74

No.	Characteristics	Symbol	Limits		Unit	Remarks
			Min.	Max.		
1	Resonance Frequency	f_L	8.194442		MHz	
2	Reference Temperature	T_0	+23	+27	°C	
3	Overtone Order	-	Fundamental			
4	Load Capacitance	C_L	30		pF	
5	Rated Drive Level	P_0	0.1		mW	
6	Frequency Adjustment Tolerance	$\frac{\Delta f}{f}$	-10	+10	10 ⁻⁶	At T_0 °C
7	Resonance Resistance	R_L	-	40	Ω	At T_0 °C
8	Frequency Variation with Temperature over T_{op}	$\frac{\Delta f}{f}$	-10	+10	10 ⁻⁶	From frequency measured at T_0 °C
9	Resistance Variation with Temperature over T_{op}	$\frac{\Delta R}{R}$	-10	+10	%	From resistance measured at T_0 °C If $R < 10\Omega$
			-1.5	+1.5	Ω	
10	Operating Temperature Range	T_{op}	-20	+50	°C	
11	Frequency variation with Drive Level	$\frac{\Delta f}{f}$	Not applicable		10 ⁻⁶	
12	Resistance variation with Drive Level	$\frac{\Delta R}{R}$	Not applicable		%	
13	Motional Inductance	L_1	Not applicable		mH	
14	Motional Capacitance	C_1	Not applicable		fF	
15	Static Capacitance	C_0	-	7.0	pF	
16	Q Factor	Q	80 000	-	-	
17	Ratio of Unwanted: Response Resistance to Resonance Resistance or Response Impedance to Resonance Resistance	R_p/R or $ Z_p /R$	2:1	-		In the frequency range: $f_L - 200\text{kHz}$ to $f_L + 200\text{kHz}$
18	Ageing	$\frac{\Delta f}{f}$	-5.0 -10	+5.0 +10	10 ⁻⁶	After burn-in. Over 10 years
19	Lead Finish	-	2		-	



TABLE 1(a) - TYPE VARIANT DETAILED INFORMATION

TYPE VARIANT NO. 75

No.	Characteristics	Symbol	Limits		Unit	Remarks
			Min.	Max.		
1	Resonance Frequency	f_L	10.0		MHz	
2	Reference Temperature	T_0	+25		°C	
3	Overtone Order	-	Fundamental			
4	Load Capacitance	C_L	30		pF	
5	Rated Drive Level	P_0	0.1		mW	
6	Frequency Adjustment Tolerance	$\frac{\Delta f}{f}$	-50	+50	10^{-6}	At T_0 °C
7	Resonance Resistance	R_L	-	30	Ω	At T_0 °C
8	Frequency Variation with Temperature over T_{op}	$\frac{\Delta f}{f}$	-50	+50	10^{-6}	From frequency measured at T_0 °C
9	Resistance Variation with Temperature over T_{op}	$\frac{\Delta R}{R}$	Not applicable		%	
10	Operating Temperature Range	T_{op}	-40	+70	°C	
11	Frequency variation with Drive Level	$\frac{\Delta f}{f}$	Not applicable		10^{-6}	
12	Resistance variation with Drive Level	$\frac{\Delta R}{R}$	Not applicable		%	
13	Motional Inductance	L_1	Not applicable		mH	
14	Motional Capacitance	C_1	Not applicable		fF	
15	Static Capacitance	C_0	Not applicable		pF	
16	Q Factor	Q	Not applicable		-	
17	Ratio of Unwanted: Response Resistance to Resonance Resistance or Response Impedance to Resonance Resistance	R_p/R or $ Z_p /R$	Not applicable			
18	Ageing	$\frac{\Delta f}{f}$	-50	+50	10^{-6}	Over 5 years
19	Lead Finish	-	2		-	

TABLE 1(a) - TYPE VARIANT DETAILED INFORMATION

TYPE VARIANT NO. 76

No.	Characteristics	Symbol	Limits		Unit	Remarks
			Min.	Max.		
1	Resonance Frequency	f_L	4.0		MHz	Synthetic swept
2	Reference Temperature	T_0	+ 25		°C	High temperature cured
3	Overtone Order	-	Fundamental			AT cut
4	Load Capacitance	C_L	50		pF	
5	Rated Drive Level	P_0	0.1		mW	
6	Frequency Adjustment Tolerance	$\frac{\Delta f}{f}$	-10	+ 10	10^{-6}	At T_0 °C
7	Resonance Resistance	R_L	-	20	Ω	Over T_{op} °C
8	Frequency Variation with Temperature over T_{op}	$\frac{\Delta f}{f}$	-15	+ 15	10^{-6}	From frequency measured at T_0 °C measured each 2.5°C
9	Resistance Variation with Temperature over T_{op}	$\frac{\Delta R}{R}$	Not applicable		%	
10	Operating Temperature Range	T_{op}	-35	+ 70	°C	
11	Frequency variation with Drive Level	$\frac{\Delta f}{f}$	Not applicable		10^{-6}	
12	Resistance variation with Drive Level	$\frac{\Delta R}{R}$	Not applicable		%	
13	Motional Inductance	L_1	Not applicable		mH	
14	Motional Capacitance	C_1	Not applicable		fF	
15	Static Capacitance	C_0	-	7.0	pF	
16	Q Factor	Q	100 000	-	-	
17	Ratio of Unwanted: Response Resistance to Resonance Resistance or Response Impedance to Resonance Resistance	R_p/R or $ Z_p /R$	Not applicable			
18	Ageing	$\frac{\Delta f}{f}$	-5.0	+ 5.0	10^{-6}	After burn-in and per year
19	Lead Finish	-	2		-	

TABLE 1(a) - TYPE VARIANT DETAILED INFORMATION

TYPE VARIANT NO. 77

No.	Characteristics	Symbol	Limits		Unit	Remarks
			Min.	Max.		
1	Resonance Frequency	f_L	8.388		MHz	
2	Reference Temperature	T_0	+23	+27	°C	
3	Overtone Order	-	Fundamental			
4	Load Capacitance	C_L	30		pF	
5	Rated Drive Level	P_0	0.1		mW	
6	Frequency Adjustment Tolerance	$\frac{\Delta f}{f}$	-20	+20	10^{-6}	At T_0 °C
7	Resonance Resistance	R_L	-	40	Ω	At T_0 °C
8	Frequency Variation with Temperature over T_{op}	$\frac{\Delta f}{f}$	-50	+50	10^{-6}	From frequency measured at T_0 °C
9	Resistance Variation with Temperature over T_{op}	$\frac{\Delta R}{R}$	-10 or -1.5	+10 +1.5	% Ω	From resistance measured at T_0 °C If $R < 10\Omega$
10	Operating Temperature Range	T_{op}	-10	+50	°C	
11	Frequency variation with Drive Level	$\frac{\Delta f}{f}$	Not applicable		10^{-6}	
12	Resistance variation with Drive Level	$\frac{\Delta R}{R}$	Not applicable		%	
13	Motional Inductance	L_1	Not applicable		mH	
14	Motional Capacitance	C_1	Not applicable		fF	
15	Static Capacitance	C_0	-	7.0	pF	
16	Q Factor	Q	80 000	-	-	
17	Ratio of Unwanted: Response Resistance to Resonance Resistance or Response Impedance to Resonance Resistance	R_p/R or $ Z_p /R$	2:1	-		In the frequency range: $f_L - 200\text{kHz}$ to $f_L + 200\text{kHz}$
18	Ageing	$\frac{\Delta f}{f}$	-5.0	+5.0	10^{-6}	Per year after burn-in at T_0
19	Lead Finish	-	2		-	

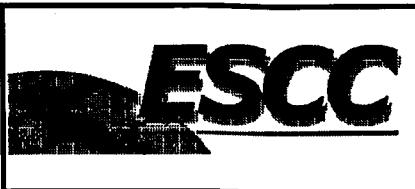

TABLE 1(a) - TYPE VARIANT DETAILED INFORMATION

TYPE VARIANT NO. 78

No.	Characteristics	Symbol	Limits		Unit	Remarks
			Min.	Max.		
1	Resonance Frequency	f_L	4.194304		MHz	
2	Reference Temperature	T_0	+23	+27	°C	
3	Overtone Order	-	Fundamental			
4	Load Capacitance	C_L	30		pF	
5	Rated Drive Level	P_0	0.1		mW	
6	Frequency Adjustment Tolerance	$\frac{\Delta f}{f}$	-10	+10	10^{-6}	At T_0 °C
7	Resonance Resistance	R_L	-	40	Ω	At T_0 °C
8	Frequency Variation with Temperature over T_{op}	$\frac{\Delta f}{f}$	-15	+15	10^{-6}	From frequency measured at T_0 °C
9	Resistance Variation with Temperature over T_{op}	$\frac{\Delta R}{R}$	-10	+10	%	From resistance measured at T_0 °C If $R < 10\Omega$
			-1.5	+1.5	Ω	
10	Operating Temperature Range	T_{op}	-30	+70	°C	
11	Frequency variation with Drive Level	$\frac{\Delta f}{f}$	Not applicable		10^{-6}	
12	Resistance variation with Drive Level	$\frac{\Delta R}{R}$	Not applicable		%	
13	Motional Inductance	L_1	Not applicable		mH	
14	Motional Capacitance	C_1	Not applicable		fF	
15	Static Capacitance	C_0	-	7.0	pF	
16	Q Factor	Q	200 000	-	-	
17	Ratio of Unwanted: Response Resistance to Resonance Resistance or Response Impedance to Resonance Resistance	R_p/R or $ Z_p /R$	2:1	-		In the frequency range: $f_L - 200\text{kHz}$ to $f_L + 200\text{kHz}$
18	Ageing	$\frac{\Delta f}{f}$	-3.0	+3.0	10^{-6}	Per year after burn-in at T_0
19	Lead Finish	-	2		-	

TABLE 1(a) - TYPE VARIANT DETAILED INFORMATION

TYPE VARIANT NO. 79

No.	Characteristics	Symbol	Limits		Unit	Remarks
			Min.	Max.		
1	Resonance Frequency	f_L	3.2768		MHz	
2	Reference Temperature	T_o	+ 23	+ 27	°C	
3	Overtone Order	-	Fundamental			
4	Load Capacitance	C_L	30		pF	
5	Rated Drive Level	P_o	0.1		mW	
6	Frequency Adjustment Tolerance	$\frac{\Delta f}{f}$	-10	+ 10	10^{-6}	At T_o °C
7	Resonance Resistance	R_L	-	50	Ω	At T_o °C
8	Frequency Variation with Temperature over T_{op}	$\frac{\Delta f}{f}$	-20	+ 20	10^{-6}	From frequency measured at T_o °C
9	Resistance Variation with Temperature over T_{op}	$\frac{\Delta R}{R}$	-20 or -1.0	+ 20 or + 1.0	% Ω	From resistance measured at T_o °C
10	Operating Temperature Range	T_{op}	-30	+ 70	°C	
11	Frequency variation with Drive Level	$\frac{\Delta f}{f}$	Not applicable		10^{-6}	
12	Resistance variation with Drive Level	$\frac{\Delta R}{R}$	Not applicable		%	
13	Motional Inductance	L_1	Not applicable		mH	
14	Motional Capacitance	C_1	Not applicable		fF	
15	Static Capacitance	C_o	-	7.0	pF	
16	Q Factor	Q	200 000	-	-	
17	Ratio of Unwanted: Response Resistance to Resonance Resistance or Response Impedance to Resonance Resistance	R_p/R or $ Z_p /R$	2:1	-		In the frequency range: $f_L - 200\text{kHz}$ to $f_L + 200\text{kHz}$
18	Ageing	$\frac{\Delta f}{f}$	-1.0	+ 1.0	10^{-6}	Per year after burn-in
19	Lead Finish	-	2		-	

TABLE 1(a) - TYPE VARIANT DETAILED INFORMATION

TYPE VARIANT NO. 80

No.	Characteristics	Symbol	Limits		Unit	Remarks
			Min.	Max.		
1	Resonance Frequency	f_L	16.0		MHz	
2	Reference Temperature	T_0	+23	+27	°C	
3	Overtone Order	-	Fundamental			
4	Load Capacitance	C_L	30		pF	
5	Rated Drive Level	P_0	0.1		mW	
6	Frequency Adjustment Tolerance	$\frac{\Delta f}{f}$	-10	+10	10^{-6}	At T_0 °C
7	Resonance Resistance	R_L	-	30	Ω	At T_0 °C
8	Frequency Variation with Temperature over T_{op}	$\frac{\Delta f}{f}$	-15	+15	10^{-6}	From frequency measured at T_0 °C
9	Resistance Variation with Temperature over T_{op}	$\frac{\Delta R}{R}$	-10	+10	%	From resistance measured at T_0 °C If $R < 10\Omega$
			-1.5	+1.5	Ω	
10	Operating Temperature Range	T_{op}	-30	+70	°C	
11	Frequency variation with Drive Level	$\frac{\Delta f}{f}$	Not applicable		10^{-6}	
12	Resistance variation with Drive Level	$\frac{\Delta R}{R}$	Not applicable		%	
13	Motional Inductance	L_1	Not applicable		mH	
14	Motional Capacitance	C_1	Not applicable		fF	
15	Static Capacitance	C_0	-	7.0	pF	
16	Q Factor	Q	80 000	-	-	
17	Ratio of Unwanted: Response Resistance to Resonance Resistance or Response Impedance to Resonance Resistance	R_p/R or $ Z_p /R$	2:1	-		In the frequency range: $f_L - 200\text{kHz}$ to $f_L + 200\text{kHz}$
18	Ageing	$\frac{\Delta f}{f}$	-1.0	+1.0	10^{-6}	Per year after burn-in at T_0
19	Lead Finish	-	2		-	



TABLE 1(a) - TYPE VARIANT DETAILED INFORMATION

TYPE VARIANT NO. 81

No.	Characteristics	Symbol	Limits		Unit	Remarks
			Min.	Max.		
1	Resonance Frequency	f_L	15.0		MHz	
2	Reference Temperature	T_o	+23	+27	°C	
3	Overtone Order	-	Fundamental			
4	Load Capacitance	C_L	30		pF	
5	Rated Drive Level	P_o	0.1		mW	
6	Frequency Adjustment Tolerance	$\frac{\Delta f}{f}$	-10	+10	10^{-6}	At T_o °C
7	Resonance Resistance	R_L	-	30	Ω	At T_o °C
8	Frequency Variation with Temperature over T_{op}	$\frac{\Delta f}{f}$	-15	+15	10^{-6}	From frequency measured at T_o °C
9	Resistance Variation with Temperature over T_{op}	$\frac{\Delta R}{R}$	-10 or -1.5	+10 +1.5	% Ω	From resistance measured at T_o °C If $R < 10\Omega$
10	Operating Temperature Range	T_{op}	-30	+70	°C	
11	Frequency variation with Drive Level	$\frac{\Delta f}{f}$	Not applicable		10^{-6}	
12	Resistance variation with Drive Level	$\frac{\Delta R}{R}$	Not applicable		%	
13	Motional Inductance	L_1	Not applicable		mH	
14	Motional Capacitance	C_1	Not applicable		fF	
15	Static Capacitance	C_o	-	7.0	pF	
16	Q Factor	Q	80 000	-	-	
17	Ratio of Unwanted: Response Resistance to Resonance Resistance or Response Impedance to Resonance Resistance	R_p/R or $ Z_p /R$	2:1	-		In the frequency range: $f_L - 200kHz$ to $f_L + 200kHz$
18	Ageing	$\frac{\Delta f}{f}$	-1.0	+1.0	10^{-6}	Per year after burn-in
19	Lead Finish	-	2		-	



TABLE 1(a) - TYPE VARIANT DETAILED INFORMATION

TYPE VARIANT NO. 82

No.	Characteristics	Symbol	Limits		Unit	Remarks
			Min.	Max.		
1	Resonance Frequency	f_r	4.096		MHz	
2	Reference Temperature	T_o	+ 23	+ 27	°C	
3	Overtone Order	-	Fundamental			
4	Load Capacitance	C_L	∞		pF	
5	Rated Drive Level	P_o	0.1		mW	
6	Frequency Adjustment Tolerance	$\frac{\Delta f}{f}$	-10	+ 10	10^{-6}	At T_o °C
7	Resonance Resistance	R_r	-	50	Ω	At T_o °C
8	Frequency Variation with Temperature over T_{op}	$\frac{\Delta f}{f}$	-15	+ 15	10^{-6}	From frequency measured at T_o °C
9	Resistance Variation with Temperature over T_{op}	$\frac{\Delta R}{R}$	-20 or -2.0	+ 20 or + 2.0	% Ω	From resistance measured at T_o °C
10	Operating Temperature Range	T_{op}	-30	+ 80	°C	
11	Frequency variation with Drive Level	$\frac{\Delta f}{f}$	Not applicable		10^{-6}	
12	Resistance variation with Drive Level	$\frac{\Delta R}{R}$	Not applicable		%	
13	Motional Inductance	L_1	Not applicable		mH	
14	Motional Capacitance	C_1	Not applicable		fF	
15	Static Capacitance	C_o	Not applicable		pF	
16	Q Factor	Q	70 000	-	-	
17	Ratio of Unwanted: Response Resistance to Resonance Resistance or Response Impedance to Resonance Resistance	R_p/R $ Z_p /R$	3:1	-		In the frequency range: $f_r - 10\%$ to $f_r + 10\%$
18	Ageing	$\frac{\Delta f}{f}$	-3.0	+ 3.0	10^{-6}	
19	Lead Finish	-	2		-	

TABLE 1(a) - TYPE VARIANT DETAILED INFORMATION

TYPE VARIANT NO. 83

No.	Characteristics	Symbol	Limits		Unit	Remarks
			Min.	Max.		
1	Resonance Frequency	f_L	10.0		MHz	
2	Reference Temperature	T_0	+23	+27	°C	
3	Overtone Order	-	Fundamental			
4	Load Capacitance	C_L	30		pF	
5	Rated Drive Level	P_0	0.1		mW	
6	Frequency Adjustment Tolerance	$\frac{\Delta f}{f}$	-10	+10	10^{-6}	At T_0 °C
7	Resonance Resistance	R_L	-	30	Ω	At T_0 °C
8	Frequency Variation with Temperature over T_{op}	$\frac{\Delta f}{f}$	-30	+30	10^{-6}	From frequency measured at T_0 °C
9	Resistance Variation with Temperature over T_{op}	$\frac{\Delta R}{R}$	-20 or -2.0	+20 or +2.0	% Ω	From resistance measured at T_0 °C If $R \leq 10\Omega$
10	Operating Temperature Range	T_{op}	-55	+100	°C	
11	Frequency variation with Drive Level	$\frac{\Delta f}{f}$	Not applicable		10^{-6}	
12	Resistance variation with Drive Level	$\frac{\Delta R}{R}$	Not applicable		%	
13	Motional Inductance	L_1	Not applicable		mH	
14	Motional Capacitance	C_1	Not applicable		fF	
15	Static Capacitance	C_0	-	7.0	pF	
16	Q Factor	Q	100 000	-	-	
17	Ratio of Unwanted: Response Resistance to Resonance Resistance or Response Impedance to Resonance Resistance	R_p/R or $ Z_p /R$	2:1	-		In the frequency range: $f_L - 200\text{kHz}$ to $f_L + 200\text{kHz}$
18	Ageing	$\frac{\Delta f}{f}$	-2.0	+2.0	10^{-6}	Per year after burn-in at T_0
19	Lead Finish	-	2		-	



TABLE 1(a) - TYPE VARIANT DETAILED INFORMATION

TYPE VARIANT NO. 84

No.	Characteristics	Symbol	Limits		Unit	Remarks
			Min.	Max.		
1	Resonance Frequency	f_L	18.0		MHz	
2	Reference Temperature	T_0	+ 23	+ 27	°C	
3	Overtone Order	-	Fundamental			
4	Load Capacitance	C_L	28	32	pF	
5	Rated Drive Level	P_0	0.2		mW	
6	Frequency Adjustment Tolerance	$\frac{\Delta f}{f}$	-5.0	+5.0	10^{-6}	At T_0 °C
7	Resonance Resistance	R_L	-	20	Ω	At T_0 °C
8	Frequency Variation with Temperature over T_{op}	$\frac{\Delta f}{f}$	(a) -5.0 (b) -8.0	+5.0 +8.0	10^{-6}	From frequency measured at T_0 °C
9	Resistance Variation with Temperature over T_{op}	$\frac{\Delta R}{R}$	-10 -1.5	+10 +1.5	% Ω	From resistance measured at T_0 °C If $R < 10\Omega$
10	Operating Temperature Range	T_{op}	(a) 0 (b) -10	+60 +70	°C	
11	Frequency variation with Drive Level	$\frac{\Delta f}{f}$	Not applicable		10^{-6}	
12	Resistance variation with Drive Level	$\frac{\Delta R}{R}$	Not applicable		%	
13	Motional Inductance	L_1	Not applicable		mH	
14	Motional Capacitance	C_1	Not applicable		fF	
15	Static Capacitance	C_0	-	7.0	pF	
16	Q Factor	Q	70 000	-	-	
17	Ratio of Unwanted: Response Resistance to Resonance Resistance or Response Impedance to Resonance Resistance	R_p/R or $ Z_p /R$	3:1	-		In the frequency range: $f_L - 10\%$ to $f_L + 10\%$
18	Ageing	$\frac{\Delta f}{f}$	-2.0	+2.0	10^{-6}	Per year
19	Lead Finish	-	2		-	

TABLE 1(a) - TYPE VARIANT DETAILED INFORMATION

TYPE VARIANT NO. 85

No.	Characteristics	Symbol	Limits		Unit	Remarks
			Min.	Max.		
1	Resonance Frequency	f_r	25.0		MHz	Swept
2	Reference Temperature	T_o	+25		°C	
3	Overtone Order	-	3			
4	Load Capacitance	C_L	∞		pF	
5	Rated Drive Level	P_o	0.1		mW	
6	Frequency Adjustment Tolerance	$\frac{\Delta f}{f}$	-10	+10	10^{-6}	At T_o °C
7	Resonance Resistance	R_r	-	15	Ω	At T_o °C
8	Frequency Variation with Temperature over T_{op}	$\frac{\Delta f}{f}$	-10	+10	10^{-6}	From frequency measured at T_o °C
9	Resistance Variation with Temperature over T_{op}	$\frac{\Delta R}{R}$	-20	+20	%	From resistance measured at T_o °C
10	Operating Temperature Range	T_{op}	-25	+75	°C	
11	Frequency variation with Drive Level	$\frac{\Delta f}{f}$	-10	+10	10^{-6}	From $P_{S1} = 0.05mW$ to $P_{S2} = 0.2mW$
12	Resistance variation with Drive Level	$\frac{\Delta R}{R}$	-10	+10	%	From $P_{S1} = 0.05mW$ to $P_{S2} = 0.2mW$
13	Motional Inductance	L_1	17	21	mH	
14	Motional Capacitance	C_1	Not applicable		fF	
15	Static Capacitance	C_o	-	5.0	pF	
16	Q Factor	Q	300 000	-	-	
17	Unwanted Response Resistance	R_p	500	-	Ω	In the frequency range: f_r to $f_r + 200kHz$ $f_r + 200$ to $f_r + 300kHz$ $f_r + 300$ to $f_r + 500kHz$ $f_r + 500$ to $f_r + 2000kHz$
			1.0	-	k Ω	
			3.5	-	k Ω	
			35.0	-	k Ω	
18	Ageing	$\frac{\Delta f}{f}$	-10	+10	10^{-6}	After burn-in and per year
19	Lead Finish	-	2		-	



TABLE 1(a) - TYPE VARIANT DETAILED INFORMATION

TYPE VARIANT NO. 86

	Characteristics	Symbol	Limits		Unit	Remarks
			Min.	Max.		
1	Resonance Frequency	f_r	3.6864		MHz	
2	Reference Temperature	T_o	+25		°C	
3	Overtone Order	-	Fundamental			
4	Load Capacitance	C_L	∞		pF	
5	Rated Drive Level	P_o	0.1		mW	
6	Frequency Adjustment Tolerance	$\frac{\Delta f}{f}$	-10	+10	10^{-6}	At T_o °C
7	Resonance Resistance	R_r	-	50	Ω	Over T_{op} °C
8	Frequency Variation with Temperature over T_{op}	$\frac{\Delta f}{f}$	-15	+15	10^{-6}	From frequency measured at T_o °C
9	Resistance Variation with Temperature over T_{op}	$\frac{\Delta R}{R}$	Not applicable		%	
10	Operating Temperature Range	T_{op}	-25	+80	°C	
11	Frequency variation with Drive Level	$\frac{\Delta f}{f}$	Not applicable		10^{-6}	
12	Resistance variation with Drive Level	$\frac{\Delta R}{R}$	Not applicable		%	
13	Motional Inductance	L_1	Not applicable		mH	
14	Motional Capacitance	C_1	Not applicable		fF	
15	Static Capacitance	C_o	Not applicable		pF	
16	Q Factor	Q	75 000	-	-	
17	Ratio of Unwanted: Response Resistance to Resonance Resistance or Response Impedance to Resonance Resistance	R_p/R or $ Z_p /R$	5:1	-		In the frequency range: $f_r -10\%$ to $f_r +10\%$
18	Ageing	$\frac{\Delta f}{f}$	-3.0	+3.0	10^{-6}	After burn-in and per year
19	Lead Finish	-	2		-	

TABLE 1(a) - TYPE VARIANT DETAILED INFORMATION

TYPE VARIANT NO. 87

No.	Characteristics	Symbol	Limits		Unit	Remarks
			Min.	Max.		
1	Resonance Frequency	f_L	5.24288		MHz	
2	Reference Temperature	T_o	+ 60		°C	
3	Overtone Order	-	Fundamental			
4	Load Capacitance	C_L	22		pF	
5	Rated Drive Level	P_o	0.1		mW	
6	Frequency Adjustment Tolerance	$\frac{\Delta f}{f}$	-10	+ 10	10^{-6}	At T_o °C
7	Resonance Resistance	R_L	-	13	Ω	Over T_{op} °C
8	Frequency Variation with Temperature over T_{op}	$\frac{\Delta f}{f}$	-15	+ 15	10^{-6}	From frequency measured at T_o °C
9	Resistance Variation with Temperature over T_{op}	$\frac{\Delta R}{R}$	Not applicable		%	
10	Operating Temperature Range	T_{op}	-20	+ 70	°C	
11	Frequency variation with Drive Level	$\frac{\Delta f}{f}$	Not applicable		10^{-6}	
12	Resistance variation with Drive Level	$\frac{\Delta R}{R}$	Not applicable		%	
13	Motional Inductance	L_1	Not applicable		mH	
14	Motional Capacitance	C_1	Not applicable		fF	
15	Static Capacitance	C_o	Not applicable		pF	
16	Q Factor	Q	50 000	-	-	
17	Ratio of Unwanted: Response Resistance to Resonance Resistance or Response Impedance to Resonance Resistance	R_p/R $ Z_p /R$	3:1	-		In the frequency range: f_L -200kHz to f_L + 200kHz
18	Ageing	$\frac{\Delta f}{f}$	-3.0	+ 3.0	10^{-6}	After burn-in and per year
19	Lead Finish	-	2		-	



TABLE 1(a) - TYPE VARIANT DETAILED INFORMATION

TYPE VARIANT NO. 88

No.	Characteristics	Symbol	Limits		Unit	Remarks
			Min.	Max.		
1	Resonance Frequency	f_L	12.0		MHz	
2	Reference Temperature	T_0	+23	+27	°C	
3	Overtone Order	-	Fundamental			
4	Load Capacitance	C_L	28	32	pF	
5	Rated Drive Level	P_0	0.2		mW	
6	Frequency Adjustment Tolerance	$\frac{\Delta f}{f}$	-10	+10	10^{-6}	At T_0 °C
7	Resonance Resistance	R_L	-	25	Ω	At T_0 °C
8	Frequency Variation with Temperature over T_{op}	$\frac{\Delta f}{f}$	-25	+25	10^{-6}	From frequency measured at T_0 °C
9	Resistance Variation with Temperature over T_{op}	$\frac{\Delta R}{R}$	-10	+10 or -1.5 +1.5	% Ω	From resistance measured at T_0 °C If $R < 10\Omega$
10	Operating Temperature Range	T_{op}	-10	+80	°C	
11	Frequency variation with Drive Level	$\frac{\Delta f}{f}$	Not applicable		10^{-6}	
12	Resistance variation with Drive Level	$\frac{\Delta R}{R}$	Not applicable		%	
13	Motional Inductance	L_1	Not applicable		mH	
14	Motional Capacitance	C_1	Not applicable		fF	
15	Static Capacitance	C_0	-	7.0	pF	
16	Q Factor	Q	50 000	-	-	
17	Ratio of Unwanted: Response Resistance to Resonance Resistance or Response Impedance to Resonance Resistance	R_p/R or $ Z_p /R$	3:1	-		In the frequency range: $f_L -10\%$ to $f_L +10\%$
18	Ageing	$\frac{\Delta f}{f}$	-3.0	+3.0	10^{-6}	Per year
19	Lead Finish	-	2		-	

TABLE 1(a) - TYPE VARIANT DETAILED INFORMATION

TYPE VARIANT NO. 89

No.	Characteristics	Symbol	Limits		Unit	Remarks
			Min.	Max.		
1	Resonance Frequency	f_L	3.6864		MHz	
2	Reference Temperature	T_o	+23	+27	°C	
3	Overtone Order	-	Fundamental			
4	Load Capacitance	C_L	28	32	pF	
5	Rated Drive Level	P_o	0.2		mW	
6	Frequency Adjustment Tolerance	$\frac{\Delta f}{f}$	-10	+10	10^{-6}	At T_o °C
7	Resonance Resistance	R_L	-	100	Ω	At T_o °C
8	Frequency Variation with Temperature over T_{op}	$\frac{\Delta f}{f}$	-25	+25	10^{-6}	From frequency measured at T_o °C
9	Resistance Variation with Temperature over T_{op}	$\frac{\Delta R}{R}$	-20 or -2.0	+20 or +2.0	% Ω	From resistance measured at T_o °C If $R \leq 10\Omega$
10	Operating Temperature Range	T_{op}	-10	+80	°C	
11	Frequency variation with Drive Level	$\frac{\Delta f}{f}$	Not applicable		10^{-6}	
12	Resistance variation with Drive Level	$\frac{\Delta R}{R}$	Not applicable		%	
13	Motional Inductance	L_1	Not applicable		mH	
14	Motional Capacitance	C_1	Not applicable		fF	
15	Static Capacitance	C_o	-	7.0	pF	
16	Q Factor	Q	75 000	-	-	
17	Ratio of Unwanted: Response Resistance to Resonance Resistance or Response Impedance to Resonance Resistance	R_p/R $ Z_p /R$	5:1	-		In the frequency range: $f_L - 10\%$ to $f_L + 10\%$
18	Ageing	$\frac{\Delta f}{f}$	-3.0	+3.0	10^{-6}	Per year
19	Lead Finish	-	2		-	

TABLE 1(a) - TYPE VARIANT DETAILED INFORMATION

TYPE VARIANT NO. 90

No.	Characteristics	Symbol	Limits		Unit	Remarks
			Min.	Max.		
1	Resonance Frequency	f_r	12.136285		MHz	Synthetic swept
2	Reference Temperature	T_0	+23	+27	°C	High temperature cured
3	Overtone Order	-	Fundamental			AT cut
4	Load Capacitance	C_L	∞		pF	
5	Rated Drive Level	P_0	0.1		mW	
6	Frequency Adjustment Tolerance	$\frac{\Delta f}{f}$	-5.0	+5.0	10^{-6}	At T_0 °C
7	Resonance Resistance	R_r	-	20	Ω	At T_0 °C
8	Frequency Variation with Temperature over T_{op}	$\frac{\Delta f}{f}$	-10	+10	10^{-6}	From frequency measured at T_0 °C measured each 2.5°C
9	Resistance Variation with Temperature over T_{op}	$\frac{\Delta R}{R}$	-10	+10	%	From resistance measured at T_0 °C If $R < 10\Omega$
			-1.5	+1.5	Ω	
10	Operating Temperature Range	T_{op}	-30	+65	°C	
11	Frequency variation with Drive Level	$\frac{\Delta f}{f}$	-5.0	+5.0	10^{-6}	From $P_{s1} = 0.05mW$ to $P_{s2} = 0.1mW$
12	Resistance variation with Drive Level	$\frac{\Delta R}{R}$	Not applicable		%	
13	Motional Inductance	L_1	Not applicable		mH	
14	Motional Capacitance	C_1	Not applicable		fF	
15	Static Capacitance	C_0	Not applicable		pF	
16	Q Factor	Q	150 000	-	-	
17	Ratio of Unwanted: Response Resistance to Resonance Resistance or Response Impedance to Resonance Resistance	R_p/R or $ Z_p /R$	5:1	-		In the frequency range: $f_r - 10\%$ to $f_r + 10\%$
18	Ageing	$\frac{\Delta f}{f}$	-10	+10	10^{-6}	Over 10 years after burn-in
19	Lead Finish	-	2		-	

TABLE 1(a) - TYPE VARIANT DETAILED INFORMATION

TYPE VARIANT NO. 91

No.	Characteristics	Symbol	Limits		Unit	Remarks
			Min.	Max.		
1	Resonance Frequency	f_L	18.0		MHz	
2	Reference Temperature	T_0	+38	+42	°C	
3	Overtone Order	-	Fundamental			
4	Load Capacitance	C_L	50		pF	
5	Rated Drive Level	P_0	0.1		mW	
6	Frequency Adjustment Tolerance	$\frac{\Delta f}{f}$	-10	+10	10^{-6}	At T_0 °C
7	Resonance Resistance	R_L	-	20	Ω	At T_0 °C
8	Frequency Variation with Temperature over T_{op}	$\frac{\Delta f}{f}$	-15	+15	10^{-6}	From frequency measured at T_0 °C
9	Resistance Variation with Temperature over T_{op}	$\frac{\Delta R}{R}$	-10 or -1.5	+10 +1.5	% Ω	From resistance measured at T_0 °C If $R < 10\Omega$
10	Operating Temperature Range	T_{op}	-20	+80	°C	
11	Frequency variation with Drive Level	$\frac{\Delta f}{f}$	Not applicable		10^{-6}	
12	Resistance variation with Drive Level	$\frac{\Delta R}{R}$	Not applicable		%	
13	Motional Inductance	L_1	Not applicable		mH	
14	Motional Capacitance	C_1	Not applicable		fF	
15	Static Capacitance	C_0	-	7.0	pF	
16	Q Factor	Q	75 000	-	-	
17	Ratio of Unwanted: Response Resistance to Resonance Resistance or Response Impedance to Resonance Resistance	R_p/R or $ Z_p /R$	2:1	-		In the frequency range: $f_L - 200\text{kHz}$ to $f_L + 200\text{kHz}$
18	Ageing	$\frac{\Delta f}{f}$	-3.0	+3.0	10^{-6}	After burn-in and per year
19	Lead Finish	-	2		-	



TABLE 1(a) - TYPE VARIANT DETAILED INFORMATION

TYPE VARIANT NO. 92

No.	Characteristics	Symbol	Limits		Unit	Remarks
			Min.	Max.		
1	Resonance Frequency	f_r	8.388608		MHz	
2	Reference Temperature	T_0	+23	+27	°C	
3	Overtone Order	-	Fundamental			
4	Load Capacitance	C_L	∞		pF	
5	Rated Drive Level	P_0	0.1		mW	
6	Frequency Adjustment Tolerance	$\frac{\Delta f}{f}$	-5.0	+5.0	10 ⁻⁶	At T_0 °C
7	Resonance Resistance	R_r	-	20	Ω	At T_0 °C
8	Frequency Variation with Temperature over T_{op}	$\frac{\Delta f}{f}$	(a) -12 (b) -20	+20 +12	10 ⁻⁶	From frequency measured at T_0 °C
9	Resistance Variation with Temperature over T_{op}	$\frac{\Delta R}{R}$	-10 or -2.0	+10 or +2.0	% Ω	From resistance measured at T_0 °C
10	Operating Temperature Range	T_{op}	(a) -30 (b) -40	+75 +30	°C	
11	Frequency variation with Drive Level	$\frac{\Delta f}{f}$	-5.0	+5.0	10 ⁻⁶	From $P_{S1} = 0.05mW$ to $P_{S2} = 0.1mW$
12	Resistance variation with Drive Level	$\frac{\Delta R}{R}$	Not applicable		%	
13	Motional Inductance	L_1	Not applicable		mH	
14	Motional Capacitance	C_1	Not applicable		fF	
15	Static Capacitance	C_0	Not applicable		pF	
16	Q Factor	Q	130 000	-	-	
17	Ratio of Unwanted: Response Resistance to Resonance Resistance or Response Impedance to Resonance Resistance	R_p/R or $ Z_p /R$	5:1	-		In the frequency range: $f_r - 200kHz$ to $f_r + 200kHz$
18	Ageing	$\frac{\Delta f}{f}$	-3.0	+3.0	10 ⁻⁶	After burn-in, per year
19	Lead Finish	-	2		-	

TABLE 1(a) - TYPE VARIANT DETAILED INFORMATION

TYPE VARIANT NO. 93

No.	Characteristics	Symbol	Limits		Unit	Remarks
			Min.	Max.		
1	Resonance Frequency	f_L	10.0		MHz	
2	Reference Temperature	T_o	+36	+44	°C	
3	Overtone Order	-	Fundamental			
4	Load Capacitance	C_L	28	32	pF	
5	Rated Drive Level	P_o	0.1		mW	
6	Frequency Adjustment Tolerance	$\frac{\Delta f}{f}$	-10	+10	10 ⁻⁶	At T_o °C
7	Resonance Resistance	R_L	-	15	Ω	At T_o °C
8	Frequency Variation with Temperature over T_{op}	$\frac{\Delta f}{f}$	-30	+30	10 ⁻⁶	From frequency measured at T_o °C
9	Resistance Variation with Temperature over T_{op}	$\frac{\Delta R}{R}$	-10	+10 or -1.5 +1.5	% Ω	From resistance measured at T_o °C If $R < 10\Omega$
10	Operating Temperature Range	T_{op}	-20	+90	°C	
11	Frequency variation with Drive Level	$\frac{\Delta f}{f}$	Not applicable		10 ⁻⁶	
12	Resistance variation with Drive Level	$\frac{\Delta R}{R}$	Not applicable		%	
13	Motional Inductance	L_1	2.8	-	mH	
14	Motional Capacitance	C_1	Not applicable		fF	
15	Static Capacitance	C_o	-	7.0	pF	
16	Q Factor	Q	Not applicable		-	
17	Ratio of Unwanted: Response Resistance to Resonance Resistance or Response Impedance to Resonance Resistance	R_p/R $ Z_p /R$	2:1	-		In the frequency range: f_L -50kHz to f_L +50kHz
18	Ageing	$\frac{\Delta f}{f}$	-3.0	+3.0	10 ⁻⁶	Per year after burn-in
19	Lead Finish	-	2		-	



TABLE 1(a) - TYPE VARIANT DETAILED INFORMATION

TYPE VARIANT NO. 94

No.	Characteristics	Symbol	Limits		Unit	Remarks
			Min.	Max.		
1	Resonance Frequency	f_L	6.0		MHz	
2	Reference Temperature	T_o	+23	+27	°C	
3	Overtone Order	-	Fundamental			
4	Load Capacitance	C_L	30		pF	
5	Rated Drive Level	P_o	0.1		mW	
6	Frequency Adjustment Tolerance	$\frac{\Delta f}{f}$	-10	+10	10^{-6}	At T_o °C
7	Resonance Resistance	R_L	-	50	Ω	At T_o °C
8	Frequency Variation with Temperature over T_{op}	$\frac{\Delta f}{f}$	-15	+15	10^{-6}	From frequency measured at T_o °C
9	Resistance Variation with Temperature over T_{op}	$\frac{\Delta R}{R}$	-20 or -2.0	+20 or +2.0	% Ω	From resistance measured at T_o °C
10	Operating Temperature Range	T_{op}	-45	+75	°C	
11	Frequency variation with Drive Level	$\frac{\Delta f}{f}$	Not applicable		10^{-6}	
12	Resistance variation with Drive Level	$\frac{\Delta R}{R}$	Not applicable		%	
13	Motional Inductance	L_1	Not applicable		mH	
14	Motional Capacitance	C_1	Not applicable		fF	
15	Static Capacitance	C_o	Not applicable		pF	
16	Q Factor	Q	200 000	-	-	
17	Ratio of Unwanted: Response Resistance to Resonance Resistance or Response Impedance to Resonance Resistance	R_p/R or $ Z_p /R$	2:1	-		In the frequency range: $f_L - 50\text{kHz}$ to $f_L + 50\text{kHz}$
18	Ageing	$\frac{\Delta f}{f}$	-3.0	+3.0	10^{-6}	Per year after burn-in
19	Lead Finish	-	2		-	

TABLE 1(a) - TYPE VARIANT DETAILED INFORMATION

TYPE VARIANT NO. 95

No.	Characteristics	Symbol	Limits		Unit	Remarks
			Min.	Max.		
1	Resonance Frequency	f_L	12.5		MHz	
2	Reference Temperature	T_o	+23	+27	°C	
3	Overtone Order	-	Fundamental			
4	Load Capacitance	C_L	30		pF	
5	Rated Drive Level	P_o	0.1		mW	
6	Frequency Adjustment Tolerance	$\frac{\Delta f}{f}$	-20	+20	10^{-6}	At T_o °C
7	Resonance Resistance	R_L	-	30	Ω	At T_o °C
8	Frequency Variation with Temperature over T_{op}	$\frac{\Delta f}{f}$	-30	+30	10^{-6}	From frequency measured at T_o °C
9	Resistance Variation with Temperature over T_{op}	$\frac{\Delta R}{R}$	-20 or -2.0	+20 or +2.0	% Ω	From resistance measured at T_o °C
10	Operating Temperature Range	T_{op}	-40	+85	°C	
11	Frequency variation with Drive Level	$\frac{\Delta f}{f}$	Not applicable		10^{-6}	
12	Resistance variation with Drive Level	$\frac{\Delta R}{R}$	Not applicable		%	
13	Motional Inductance	L_1	Not applicable		mH	
14	Motional Capacitance	C_1	Not applicable		fF	
15	Static Capacitance	C_o	Not applicable		pF	
16	Q Factor	Q	Not applicable		-	
17	Ratio of Unwanted: Response Resistance to Resonance Resistance or Response Impedance to Resonance Resistance	R_p/R or $ Z_p /R$	2:1	-		In the frequency range: $f_L - 50\text{kHz}$ to $f_L + 50\text{kHz}$
18	Ageing	$\frac{\Delta f}{f}$	-10	+10	10^{-6}	5 years after burn-in
19	Lead Finish	-	2		-	

TABLE 1(a) - TYPE VARIANT DETAILED INFORMATION

TYPE VARIANT NO. 96

No.	Characteristics	Symbol	Limits		Unit	Remarks
			Min.	Max.		
1	Resonance Frequency	f_L	11.059		MHz	
2	Reference Temperature	T_0	+ 23	+ 27	°C	
3	Overtone Order	-	Fundamental			
4	Load Capacitance	C_L	50		pF	
5	Rated Drive Level	P_0	0.1		mW	
6	Frequency Adjustment Tolerance	$\frac{\Delta f}{f}$	-10	+ 10	10^{-6}	At T_0 °C
7	Resonance Resistance	R_L	-	20	Ω	Over T_{op} °C
8	Frequency Variation with Temperature over T_{op}	$\frac{\Delta f}{f}$	-15	+ 15	10^{-6}	From frequency measured at T_0 °C
9	Resistance Variation with Temperature over T_{op}	$\frac{\Delta R}{R}$	Not applicable		%	
10	Operating Temperature Range	T_{op}	-35	+ 70	°C	
11	Frequency variation with Drive Level	$\frac{\Delta f}{f}$	Not applicable		10^{-6}	
12	Resistance variation with Drive Level	$\frac{\Delta R}{R}$	Not applicable		%	
13	Motional Inductance	L_1	Not applicable		mH	
14	Motional Capacitance	C_1	Not applicable		fF	
15	Static Capacitance	C_0	-	7.0	pF	
16	Q Factor	Q	100 000	-	-	
17	Ratio of Unwanted: Response Resistance to Resonance Resistance or Response Impedance to Resonance Resistance	R_p/R or $ Z_p/R$	2:1	-		In the frequency range: f_L -200kHz to f_L + 200kHz
18	Ageing	$\frac{\Delta f}{f}$	-5.0	+ 5.0	10^{-6}	Per year after burn-in
19	Lead Finish	-	2		-	



TABLE 1(a) - TYPE VARIANT DETAILED INFORMATION

TYPE VARIANT NO. 97

No.	Characteristics	Symbol	Limits		Unit	Remarks
			Min.	Max.		
1	Resonance Frequency	f_L	7.3728		MHz	
2	Reference Temperature	T_o	+23	+27	°C	
3	Overtone Order	-	Fundamental			
4	Load Capacitance	C_L	30		pF	
5	Rated Drive Level	P_o	0.1		mW	
6	Frequency Adjustment Tolerance	$\frac{\Delta f}{f}$	-10	+10	10^{-6}	At T_o °C
7	Resonance Resistance	R_L	-	30	Ω	At T_o °C
8	Frequency Variation with Temperature over T_{op}	$\frac{\Delta f}{f}$	-15	+15	10^{-6}	From frequency measured at T_o °C
9	Resistance Variation with Temperature over T_{op}	$\frac{\Delta R}{R}$	-10	+10 or -1.5 +1.5	% Ω	From resistance measured at T_o °C If $R < 10\Omega$
10	Operating Temperature Range	T_{op}	-30	+80	°C	
11	Frequency variation with Drive Level	$\frac{\Delta f}{f}$	Not applicable		10^{-6}	
12	Resistance variation with Drive Level	$\frac{\Delta R}{R}$	Not applicable		%	
13	Motional Inductance	L_1	Not applicable		mH	
14	Motional Capacitance	C_1	Not applicable		fF	
15	Static Capacitance	C_o	-	7.0	pF	
16	Q Factor	Q	80 000	-	-	
17	Ratio of Unwanted: Response Resistance to Resonance Resistance or Response Impedance to Resonance Resistance	R_p/R $ Z_p /R$	2:1	-		In the frequency range: $f_L - 200kHz$ to $f_L + 200kHz$
18	Ageing	$\frac{\Delta f}{f}$	-3.0	+3.0	10^{-6}	Per year after burn-in
19	Lead Finish	-	2		-	

TABLE 1(a) - TYPE VARIANT DETAILED INFORMATION
TYPE VARIANT NO. 98

No.	Characteristics	Symbol	Limits		Unit	Remarks
			Min.	Max.		
1	Resonance Frequency	f_L	5.12		MHz	
2	Reference Temperature	T_o	+38	+42	°C	
3	Overtone Order	-	Fundamental			
4	Load Capacitance	C_L	30		pF	
5	Rated Drive Level	P_o	0.1		mW	
6	Frequency Adjustment Tolerance	$\frac{\Delta f}{f}$	-10	+10	10^{-6}	At T_o °C
7	Resonance Resistance	R_L	0	30	Ω	At T_o °C
8	Frequency Variation with Temperature over T_{op}	$\frac{\Delta f}{f}$	-15	+15	10^{-6}	From frequency measured at T_o °C
9	Resistance Variation with Temperature over T_{op}	$\frac{\Delta R}{R}$	-10 or -1.5	+10 or +1.5	% Ω	From resistance measured at T_o °C If $R < 10\Omega$
10	Operating Temperature Range	T_{op}	-40	+80	°C	
11	Frequency variation with Drive Level	$\frac{\Delta f}{f}$	Not applicable		10^{-6}	
12	Resistance variation with Drive Level	$\frac{\Delta R}{R}$	Not applicable		%	
13	Motional Inductance	L_1	Not applicable		mH	
14	Motional Capacitance	C_1	Not applicable		fF	
15	Static Capacitance	C_o	-	7.0	pF	
16	Q Factor	Q	100 000	-	-	
17	Ratio of Unwanted: Response Resistance to Resonance Resistance or Response Impedance to Resonance Resistance	R_p/R $ Z_p /R$	2:1	-		In the frequency range: $f_L - 200\text{kHz}$ to $f_L + 200\text{kHz}$
18	Ageing	$\frac{\Delta f}{f}$	-3.0	+3.0	10^{-6}	Per year after burn-in
19	Lead Finish	-	2		-	



TABLE 1(a) - TYPE VARIANT DETAILED INFORMATION

TYPE VARIANT NO. 99

No.	Characteristics	Symbol	Limits		Unit	Remarks
			Min.	Max.		
1	Resonance Frequency	f_L	10.0		MHz	
2	Reference Temperature	T_0	+65	+78	°C	Turn point
3	Overtone Order	-	3			SC cut
4	Load Capacitance	C_L	18	32	pF	
5	Rated Drive Level	P_0	0.1		mW	
6	Frequency Adjustment Tolerance	$\frac{\Delta f}{f}$	Not applicable		10^{-6}	
7	Resonance Resistance	R_L	-	90	Ω	Over T_{op} °C
8	Frequency Variation with Temperature over T_{op}	$\frac{\Delta f}{f}$	-15	+15	10^{-6}	From frequency measured at T_0 °C
9	Resistance Variation with Temperature over T_{op}	$\frac{\Delta R}{R}$	Not applicable		%	From resistance measured at T_0 °C
10	Operating Temperature Range	T_{op}	-25	+80	°C	
11	Frequency variation with Drive Level	$\frac{\Delta f}{f}$	Not applicable		10^{-6}	
12	Resistance variation with Drive Level	$\frac{\Delta R}{R}$	Not applicable		%	
13	Motional Inductance	L_1	Not applicable		mH	
14	Motional Capacitance	C_1	Not applicable		fF	
15	Static Capacitance	C_0	-	7.0	pF	
16	Q Factor	Q	800 000	-	-	
17	Ratio of Unwanted: Response Resistance to Resonance Resistance or Response Impedance to Resonance Resistance	R_p/R or $ Z_p /R$	Not applicable			
18	Ageing	$\frac{\Delta f}{f}$	-0.5	+0.5	10^{-6}	Per year after burn-in
19	Lead Finish	-	2		-	

	<p>ESCC Detail Specification No. 3501/002</p>		<p>PAGE 122 ISSUE 3</p>
---	---	--	-----------------------------

APPENDIX 'A'

Page 1 of 1

AGREED DEVIATIONS FOR C-MAC FREQUENCY PRODUCTS (F)

ITEMS AFFECTED	DESCRIPTION OF DEVIATION
Para. 4.2.2	Para. 9.3, Shock: Shall not be performed.
Para. 4.2.3	Para. 9.11, Radiographic Inspection: Shall not be performed.