



Pages 1 to 123

**CRYSTAL UNITS IN METAL HOLDER,
BASED ON TYPE T807,
FREQUENCY RANGE 4.0 - 140MHZ
ESCC Detail Specification No. 3501/001**

**ISSUE 4
November 2010**



Document Custodian: European Space Agency - see <https://escies.org>

	ESCC Detail Specification No. 3501/001		PAGE i ISSUE 4
--	---	--	-------------------

LEGAL DISCLAIMER AND COPYRIGHT

European Space Agency, Copyright © 2010. All rights reserved.

The European Space Agency disclaims any liability or responsibility, to any person or entity, with respect to any loss or damage caused, or alleged to be caused, directly or indirectly by the use and application of this ESCC publication.

This publication, without the prior permission of the European Space Agency and provided that it is not used for a commercial purpose, may be:

- copied in whole in any medium without alteration or modification.
- copied in part, in any medium, provided that the ESCC document identification, comprising the ESCC symbol, document number and document issue, is removed.

DOCUMENTATION CHANGE NOTICE

(Refer to <https://escies.org> for ESCC DCR content)

DCR No.	CHANGE DESCRIPTION
582	Specification upissued to incorporate technical changes per DCR.



TABLE OF CONTENTS

	<u>Page</u>
1. <u>GENERAL</u>	5
1.1 Scope	5
1.2 Component Type Variants	5
1.3 Maximum Ratings	5
1.4 Physical Dimensions	5
1.5 Functional Diagram	5
2. <u>APPLICABLE DOCUMENTS</u>	14
3. <u>TERMS, DEFINITIONS, ABBREVIATIONS, SYMBOLS AND UNITS</u>	14
4. <u>REQUIREMENTS</u>	14
4.1 General	14
4.2 Deviations from Generic Specification	14
4.2.1 Deviations from Special In-process Controls	14
4.2.2 Deviations from Final Production Tests	14
4.2.3 Deviations from Burn-in Tests	14
4.2.4 Deviations from Qualification Tests	14
4.2.5 Deviations from Lot Acceptance Tests	14
4.3 Mechanical Requirements	15
4.3.1 Dimension Check	15
4.3.2 Weight	15
4.3.3 Robustness of Terminations	15
4.4 Materials and Finishes	15
4.4.1 Case	15
4.4.2 Lead Material and Finish	15
4.5 Marking	15
4.5.1 General	15
4.5.2 The ESCC Component Number	15
4.5.3 Characteristics	16
4.5.4 Traceability Information	16
4.5.5 Manufacturer's Name, Symbol and Code	16
4.6 Electrical Measurements	16
4.6.1 Electrical Measurements at Reference Temperature	16
4.6.2 Electrical Measurements at High and Low Temperatures	16
4.6.3 Circuits for Electrical Measurements	16
4.7 Burn-in Tests	16
4.7.1 Parameter Drift Values	16
4.7.2 Conditions for Burn-in	16
4.7.3 Electrical Circuits for Burn-in	16
4.8 Environmental and Endurance Tests	19
4.8.1 Measurements and Inspections on Completion of Environmental Tests	19
4.8.2 Measurements and Inspections at Intermediate Points and on Completion of Endurance Tests	19
4.8.3 Conditions for Operating Life Test	19

	ESCC Detail Specification No. 3501/001		PAGE 4 ISSUE 4
---	---	--	-------------------

TABLES

	<u>Page</u>
1(a) Type Variant Summary	6
Type Variant Detailed Information	23
1(b) Maximum Ratings	9
1(c) Format for Individual Tables 1(a)	10
2 Electrical Measurements at Reference Temperature	17
3 Electrical Measurements at High and Low Temperatures	18
4 Parameter Drift Values	18
5 Conditions for Burn-in and Life Test	18
6 Measurements and Inspections on Completion of Environmental Tests and at Intermediate Points and on Completion of Endurance Testing	20

FIGURES

1 Parameter Derating Information	N/A
2 Physical Dimensions	13
3 Functional Diagram	13
4 Circuits for Electrical Measurements	N/A
5 Electrical Circuit for Burn-in and Life Test	N/A

APPENDICES (Applicable to specific Manufacturers only)

A RAKON (F)	122
B KVG Quartz Crystal Technology GmbH (D)	123

	<p style="text-align: center;">ESCC Detail Specification No. 3501/001</p>	<p>PAGE 5 ISSUE 4</p>
--	---	---------------------------

1. GENERAL

1.1 SCOPE

This specification details the values, physical and electrical characteristics, test and inspection data for Crystal Units in Metal Holder, based on Type 807, Frequency Range 4.0 - 140MHz.

It shall be read in conjunction with ESCC Generic Specification No. 3501, the requirements for which are supplemented herein.

1.2 TYPE VARIANTS

A list of the type variants of the crystal units specified herein, which are also covered by this specification, is given in "Table 1(a) - Type Variant Summary".

For each type variant, the full electrical and physical characteristics are given in individual Tables 1(a) - "Type Variant Detailed Information" at the end of this specification.

The contents of the individual Tables 1(a) shall be as shown in Table 1(c) and the characteristics therein listed shall relate to the design parameters of the individual crystal units, optimised for the intended application.

The specific characteristics shall be negotiated between the Manufacturer and the Orderer. The Manufacturer shall then apply to the ESCC Secretariat for a type variant number for each individual crystal unit concerned, by sending a finalised Table 1(a) which shall also be copied to the ESCC Executive.

1.3 MAXIMUM RATINGS

The maximum ratings, which shall not be exceeded at any time during use or storage, applicable to the crystal units specified herein, are as scheduled in Table 1(b).

1.4 PHYSICAL DIMENSIONS

The physical dimensions of the crystal units specified herein are shown in Figure 2.

1.5 FUNCTIONAL DIAGRAM

The functional diagram showing lead identification of the crystal units specified herein is shown in Figure 3.

TABLE 1(a) - TYPE VARIANT SUMMARY

Variant	Resonance Frequency (MHz)	Load Capacitance (C _L pF)	Reference Temp. (T ₀ °C)	Operating Temp. Range (T _{op} °C)	Lead Length (Dim. L mm)	
					Min.	Max.
01	65.34375	∞	+25	-25 to +70	12.7	-
02	68.4373	∞	+25	-20 to +70	12.7	-
03	71.9686	∞	+25	-20 to +70	12.7	-
04	82.53	∞	+25	-20 to +70	12.7	-
05	83.07	∞	+25	-20 to +70	12.7	-
06	83.335	∞	+25	-20 to +70	12.7	-
07	84.210526	∞	+25	-20 to +70	12.7	-
08	84.868421	∞	+25	-20 to +70	12.7	-
09	85.087737	∞	+25	-20 to +70	12.7	-
10	85.964947	∞	+25	-20 to +70	12.7	-
11	36.866968	∞	+25	-20 to +70	12.7	-
12	37.166667	∞	+25	-20 to +70	12.7	-
13	65.052865	∞	+25	-20 to +70	12.7	-
14	70.0	∞	+25	-20 to +70	12.7	-
15	102.083333	∞	+25	-20 to +50	12.7	-
16	15.0	50	+40	-20 to +80	12.7	-
17	16.0	50	+60	-30 to +70	12.7	-
18	15.84	50	+25	-55 to +105	12.7	-
19	16.0 -16.384	22	+60	-20 to +70	12.7	-
20	16.35	30	+25	-20 to +70	12.7	-
21	18.84	∞	+25	-20 to +55	12.7	-
22	18.84	32	+25	-20 to +55	12.7	-
23	15.0	32	+25	-30 to +70	12.7	-
24	20.0	22	+60	-20 to +70	12.7	-
25	36.693333	∞	+25	-20 to +70	12.7	-
26	20.8333	10	+25	-10 to +60	12.7	-
27	22.841667	30	+25	-25 to +65	12.7	-
28	22.856667	44	+25	-20 to +50	12.7	-
29	22.861667	30	+25	-20 to +65	12.7	-
30	24.184	32	+25	-10 to +50	12.7	-
31	24.5	30	+25	-20 to +60	12.7	-
32	24.5	32	+25	-20 to +55	12.7	-
33	36.666 -38.333	∞	+25	-20 to +60	12.7	-
34	38.25618	55	+22	0 to +40	12.7	-
35	55.46875	20	+45	+43 to +47	12.7	-
36	62.5 - 68.125	10	+25	-10 to +60	12.7	-
37	71.859475	57.5	+25	-20 to +50	12.7	-
38	75.36015	57.5	+25	-20 to +50	12.7	-

TABLE 1(a) - TYPE VARIANT SUMMARY (Continued)

Variant	Resonance Frequency (MHz)	Load Capacitance (C _L pF)	Reference Temp. (T ₀ °C)	Operating Temp. Range (T _{op} °C)	Lead Length (Dim. L mm)	
					Min.	Max.
39	79.516319	26.5	+30	-10 to +70	12.7	-
40	80.381944	26.5	+25	-25 to +65	12.7	-
41	81.847222	26.5	+25	-25 to +65	12.7	-
42	99.1	∞	+25	-20 to +60	12.7	-
43	105.0	10	+25	-10 to +60	12.7	-
44	120.796	∞	+25	-10 to +50	12.7	-
45	61.805555	∞	+25	-20 to +70	12.7	-
46	62.5	∞	+25	-20 to +70	12.7	-
47	62.03125	∞	+25	-20 to +70	12.7	-
48	62.109375	∞	+25	-20 to +70	12.7	-
49	69.559524	∞	+25	-20 to +70	12.7	-
50	69.619048	∞	+25	-20 to +70	12.7	-
51	24.68617	30	+25	-20 to +70	12.7	-
52	82.53	∞	+25	-20 to +70	12.7	-
53	83.07	∞	+25	-20 to +70	12.7	-
54	37.063617	∞	+25	-20 to +70	12.7	-
55	37.083333	∞	+25	-20 to +70	12.7	-
56	61.1875					-
57	65.00311	∞	+25	-20 to +70	12.7	-
58	85.48	∞	+25	-20 to +70	12.7	-
59	46.08005	12	+25	-20 to +70	12.7	-
60	16.0	22	+60	-20 to +70	12.7	-
61	38.3117284	∞	+25	-20 to +60	12.7	-
62	15.0	35	+60	-30 to +70	12.7	-
63	16.0	22	+60	-20 to +70	12.7	-
64	16.384	22	+60	-20 to +70	12.7	-
65	65.0047	∞	+25	-20 to +70	12.7	-
66	65.0513	∞	+25	-20 to +70	12.7	-
67	69.9992	∞	+25	-20 to +70	12.7	-
68	85.4792	∞	+25	-20 to +70	12.7	-
69	50.0	30	+25	-5 to +55	12.7	-
70	20.0	22	+60	-20 to +70	12.7	-
71	8.0	30	+25	-35 to +105	12.7	-
72	37.74375	∞	+25	-20 to +70	12.7	-
73	37.827083	∞	+25	-20 to +70	12.7	-
74	5.24288	30	+25	-25 to +105	12.7	-
75	4.096	30	+25	-25 to +75	12.7	-
76	5.12	30	+25	-35 to +105	12.7	-
77	6.5536	30	+25	-35 to +105	12.7	-
78	65.04974	∞	+25	-20 to +70	12.7	-



TABLE 1(a) - TYPE VARIANT SUMMARY (Continued)

Variant	Resonance Frequency (MHz)	Load Capacitance (C _L pF)	Reference Temp. (T ₀ °C)	Operating Temp. Range (T _{op} °C)	Lead Length (Dim. L mm)	
					Min.	Max.
79	65.005555	∞	+25	-20 to +70	12.7	-
80	62.5	∞	+25	-20 to +70	12.7	-
81	70.0	∞	+25	-20 to +70	12.7	-
82	4.1379	30	+25	-25 to +75	12.7	-
83	65.03639	∞	+25	-20 to +70	12.7	-
84	36.811767	∞	+25	-25 to +70	12.7	-
85	20.0	∞	+25	-30 to +70	12.7	-
86	20.0	32	+25	-30 to +70	12.7	-
87	81.506849	∞	+70	-20 to +80	12.7	-
88	121.5	∞	+25	-30 to +80	12.7	-
89	50.0	∞	+25	-30 to +80	12.7	-
90	37.75625	∞	+25	-20 to +70	12.7	-
91	24.6827	∞	+25	-20 to +70	12.7	-
92	37.839583	∞	+25	-20 to +70	12.7	-
93	90.875794	∞	+25	-20 to +70	12.7	-
94	90.881675	∞	+25	-20 to +70	12.7	-
95	90.88754	∞	+25	-20 to +70	12.7	-
96	90.893413	∞	+25	-20 to +70	12.7	-
97	99.53704	∞	+25	-20 to +70	12.7	-
98	20.0	∞	+25	-55 to +105	12.7	-
99	24.5	32	+25	-20 to +70	12.7	-

NOTES

1. Full electrical and physical characteristics are given in the individual Tables 1(a) at the end of this specification.

TABLE 1(b) - MAXIMUM RATINGS

No.	Characteristic	Symbol	Values	Unit	Remarks
1	Nominal Frequency Range	f	4.0 to 140	MHz	Note 1
2	Drive Level Range	P	Note 1	mW	
3	Operating Temperature Range	T _{op}	-	°C	Note 2
4	Storage Temperature Range	T _{stg}	-65 to +125	°C	Note 3
5	Soldering Temperature	T _{sol}	+260	°C	Note 4

NOTES

1.

Fundamental and Overtone Order	Approx. Frequency Range (MHz)	Drive Level Range (mW)
Fundamental	4 - 35	0.05 to 0.2
3	30 - 100	0.05 to 0.25
5	80 - 140	0.05 to 0.25

2. See Table 1(a).

3. The duration at maximum storage temperature shall not exceed 16 hours.

4. Duration 10 seconds maximum at a distance of not less than 3.0mm from the device body and the same lead shall not be resoldered until 3 minutes have elapsed.

TABLE 1(c) - FORMAT FOR INDIVIDUAL TABLES 1(a)

TABLE 1(a) - TYPE VARIANT DETAILED INFORMATION

TYPE VARIANT NO. _____

No.	Characteristic	Symbol	Limits		Unit	Remarks
			Min.	Max		
1	Resonance Frequency	f_r			MHz	AT Cut
2	Reference Temperature	T_0			°C	
3	Overtone Order	-				
4	Load Capacitance	C_L			pF	
5	Rated Drive Level	P_0			mW	
6	Frequency Adjustment Tolerance	$\frac{\Delta f}{f}$			10^{-6}	At T_0 °C
7	Resonance Resistance	R_r			Ω	At T_0 °C
8	Frequency Variation with Temperature over T_{op}	$\frac{\Delta f}{f}$			10^{-6}	From frequency measured at T_0 °C
9	Resistance Variation with Temperature over T_{op}	$\frac{\Delta R}{R}$			%	From resistance measured at T_0 °C
10	Operating Temperature Range	T_{op}			°C	
11	Frequency Variation with Drive Level	$\frac{\Delta f}{f}$			10^{-6}	From $P_{S1} = 0.5mW$ to $P_{S2} = 0.5mW$
12	Resistance Variation with Drive Level	$\frac{\Delta R}{R}$			%	From $P_{S1} = 0.5mW$ to $P_{S2} = 0.5mW$
13	Motional Inductance	L_1			mH	
14	Motional Capacitance	C_1			fF	
15	Static Capacitance	C_0			pF	
16	Q Factor	Q			-	
17	Ratio of Unwanted: Response Resistance to Resonance Resistance or Response Impedance to Resonance Resistance	R_p/R or $ Z_p /R$				In the frequency range: $f_r - 10\%$ to $f_r + 10\%$
18	Ageing	$\frac{\Delta f}{f}$			10^{-6}	
19	Physical Dimensions					
20	Intended Application					

NOTES: See Pages 11 and 12.

NOTES TO TABLE 1(c)

1. (a) If C_L is not specified, Symbol and measurement shall be f_r .
(b) If C_L is specified, Symbol and measurement shall be f_L .
2. Reference Temperature T_0
 - (a) For a crystal unit functioning in a non-controlled temperature environment, the reference temperature is normally $+25 \pm 2$ °C.
 - (b) For a crystal unit functioning in a controlled temperature environment, the reference temperature shall normally be the mid-point of the temperature range of the controlled environment.
3. Load Capacitance C_L
 - (a) When a crystal unit must function at its series resonance frequency, C_L shall be infinite.
 - (b) When a crystal must function with a load capacitance, the C_L value shall be specified. The standard values of load capacitance are as follows:
 - Fundamental Frequency Operation: 20pF, 30pF, 50pF and 100pF.
 - Overtone Operation: 8pF, 12pF, 15pF, 20pF and 30pF.

N.B

The tolerance on the load capacitance shall be that value which results in a frequency change not exceeding 10% of the frequency tolerance at T_0 or 1% of the nominal load capacitance, whichever is smaller.

4. Rated Drive Level P_0

The rated drive level shall be selected from the standard drive levels specified below:

 - Preferred values: 2mW, 1mW, 0.5mW, 0.2mW, 0.1mW, 0.05mW, 0.02mW, 0.01mW, 0.001mW or 0.0001mW at $\pm 20\%$.
 - Non-preferred values: 10mW, 5mW and 4mW all at $\pm 20\%$.
5. Frequency Adjustment Tolerance
 - (a) When a crystal must function at its series resonance frequency, the standard value of the adjustment tolerance shall be $\pm 10 \times 10^{-6}$.
 - (b) When a crystal has to function with a load capacitance, the standard value of the adjustment tolerance shall also be $\pm 10 \times 10^{-6}$. However, if the load capacitance is adjustable, it is preferable to specify that the nominal frequency be obtained with a load capacitance value between the minimum and maximum value when the crystal is functioning in its fundamental mode.
6. Resonance Resistance
 - (a) Generally, the maximum value only is specified.
 - (b) R_L may be calculated by $R_L = R_1 \left(1 + \frac{C_0}{C_L} \right)^2$
7. Frequency and Resistance Variation with Temperature

These values shall be specified such that they are consistent with the operating temperature range.
8. Frequency and Resistance Variation with Drive Level

These limits and the Drive Level range (P_{S1} to P_{S2}) shall be specified for very special crystals only (i.e. crystals used in very high stability oscillators).



NOTES TO TABLE 1(c) (Continued)

9. Electrical Values

The electrical values shall be specified only when required for the correct functioning of the equipment in which the crystal is used.

10. Motional Inductance L_1

Because the inductance value may be restricted by other chosen parameters, the Manufacturer shall propose the value of L_1 in accordance with the Customer's requirements.

11. 'Q' Factor

If 'R' and 'L' have been already specified, it will not be necessary to specify the minimum value of the 'Q' factor.

The maximum value of the 'Q' factor is never specified.

12. Ratio of Unwanted Response Resistance to Resonance Resistance

The standard minimum value is 2, but it is possible to obtain higher values.

The frequency range within which the minimum value of the ratio is required shall also be specified.

13. Ageing

Specify limits under appropriate column and ageing period under "Remarks".

14. Terminal Lengths

To be specified if different from Figure 2 dimensions. If dimensions are as per Figure 2 then "Figure 2" to be entered in the Limits column.

15. Not applicable Items

For all items where limits are not specified, "Not applicable" shall be entered in the Limits column.

16. Intended Application

For definitions of the selected symbol to be added, see ESCC Generic Specification No. 3501, Para. 3.

FIGURE 1 - PARAMETER DERATING INFORMATION

Not applicable.

FIGURE 2 - PHYSICAL DIMENSIONS

Symbol	Millimetres		Remarks
	Min.	Max.	
ØA	-	10.70	-
C	-	6.80	-
H	4.83	5.33	Pitch 5.08mm
ØK	0.40	0.48	-
L	12.70	-	-
P	-	0.90	Note 2
Q	-	0.95	Note 2

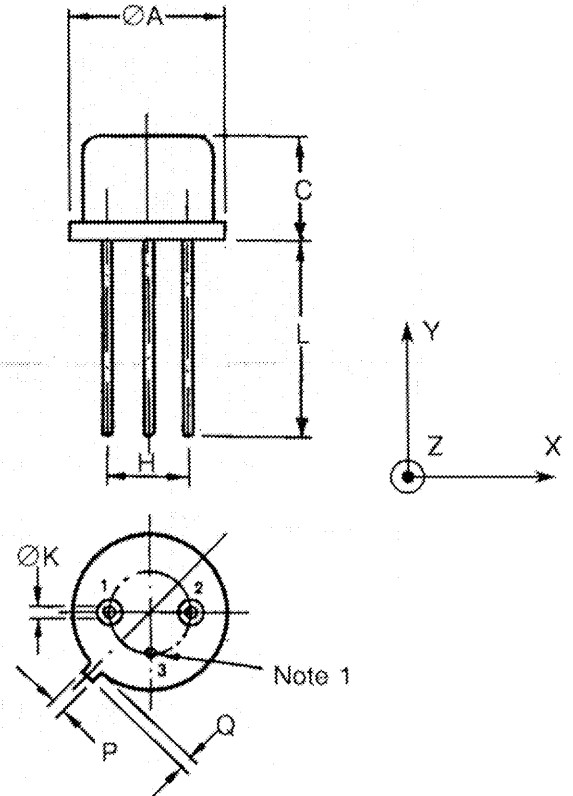

NOTES

1. Lead No. 3 is grounded to case.
2. The tag's position or presence is optional.

FIGURE 3 - FUNCTIONAL DIAGRAM

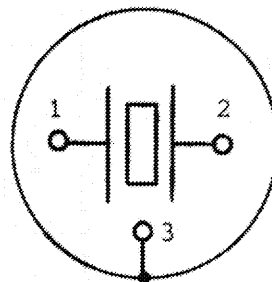

(Bottom View)



2. APPLICABLE DOCUMENTS

The following documents form part of this specification and shall be read in conjunction with it:-

- (a) ESCC Generic Specification No. 3501 for Quartz Crystal Units.

3. TERMS, DEFINITIONS, ABBREVIATIONS, SYMBOLS AND UNITS

For the purpose of this specification, the terms, definitions, abbreviations, symbols and units specified in ESCC Basic Specification No. 21300 shall apply. In addition, the following symbols are used:-

Resonance Frequency	= f_r
Load Resonance Frequency	= f_L
Reference Temperature	= T_0
Resonance Resistance	= R_r
Load Resonance Resistance	= R_L
Rated Drive Level	= P_0
Static Capacitance	= C_0
Load Capacitance	= C_L
Motional Capacitance	= C_1
Motional Inductance	= L_1
Response Resistance	= R_p
Response Impedance	= $ Z_p $
Insulation Resistance	= R_i

4. REQUIREMENTS

4.1 GENERAL

The complete requirements for procurement of the crystal units specified herein shall be as stated in this specification and ESCC Generic Specification No. 3501 for Quartz Crystal Units. Deviations from the Generic Specification applicable to this specification only, are detailed in Para. 4.2.

Deviations from the applicable Generic Specification and this Detail Specification, formally agreed with specific Manufacturers on the basis that the alternative requirements are equivalent to the ESCC requirements and do not affect the components' reliability, are listed in the appendices attached to this specification.

4.2 DEVIATIONS FROM GENERIC SPECIFICATION

4.2.1 Deviations from Special In-process Controls

None.

4.2.2 Deviations from Final Production Tests (Chart II)

None.

4.2.3 Deviations from Burn-in Tests (Chart III)

None.

4.2.4 Deviations from Qualification Tests (Chart IV)

None.

4.2.5 Deviations from Lot Acceptance Tests (Chart V)

None.

4.3 MECHANICAL REQUIREMENTS

4.3.1 Dimension Check

The dimensions of the crystal units specified herein shall be checked. They shall conform to those shown in Figure 2.

4.3.2 Weight

The maximum weight of the crystal units specified herein shall be 2.0 grammes.

4.3.3 Robustness of Terminations

The requirements for robustness of termination testing are specified in Section 9 of ESCC Generic Specification No. 3501.

4.4 MATERIALS AND FINISHES

The materials and finishes shall be as specified herein. Where a definite material is not specified, a material which will enable the crystal units specified herein to meet the performance requirements of this specification shall be used. Acceptance or approval of any constituent material does not guarantee acceptance of the finished product.

4.4.1 Case

4.4.1.1 Cap

Copper, nickel plated or nickel and gold plated.

4.4.1.2 Base

Kovar, nickel plated and gold plated.

4.4.2 Lead Material and Finish

The lead material shall be Type 'D' with Type '2' finish in accordance with the requirements of ESCC Basic Specification No. 23500.

4.5 MARKING

4.5.1 General

The marking of all components delivered to this specification shall be in accordance with the requirements of ESCC Basic Specification No. 21700 and the following paragraphs. When the component is too small to accommodate all of the marking specified, as much as space permits shall be marked and the marking information, in full, shall accompany the component in its primary package.

The information to be marked and the order of precedence, shall be as follows:-

- (a) The ESCC Component Number.
- (b) Characteristics.
- (c) Traceability Information.

4.5.2 The ESCC Component Number

Each component shall bear the ESCC Component Number, which shall be constituted and marked as follows:-

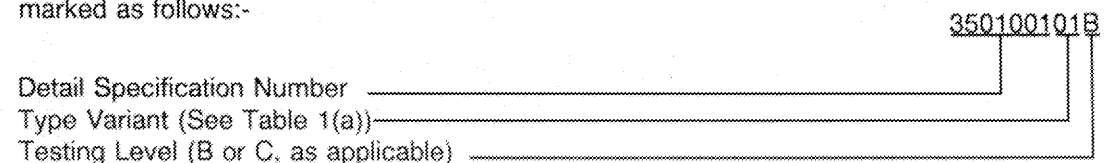



4.5.3 Characteristics

The resonance frequency of the crystal units shall be clearly specified in MHz. Where necessary, it shall be specified to 6 decimal places.

4.5.4 Traceability Information

Each component shall be marked in respect of traceability information in accordance with the requirements of ESCC Basic Specification No. 21700.

4.5.5 Manufacturer's Name, Symbol or Code

The Manufacturer's marking shall be in accordance with the requirements of ESCC Basic Specification No. 21700.

4.6 ELECTRICAL MEASUREMENTS

4.6.1 Electrical Measurements at Reference Temperature

The parameters to be measured in respect of electrical characteristics are scheduled in Table 2. The measurements shall be performed at the temperatures specified in the individual Tables 1(a), Item 2.

4.6.2 Electrical Measurements at High and Low Temperatures

The parameters to be measured at high and low temperatures are scheduled in Table 3. These measurements shall only be performed if values are specified in Table 1(a) Items 8 and/or 9.

4.6.3 Circuits for Electrical Measurements (Figure 4)

Not applicable.

4.7 BURN-IN TESTS

4.7.1 Parameter Drift Values

The parameter drift values applicable to burn-in are specified in Table 4 of this specification. Unless otherwise stated, measurements shall be performed at $T_{amb} = T_0 \pm 2$ °C. The parameter drift values (Delta) applicable to the scheduled parameters shall not be exceeded. In addition to these drift value requirements for a given parameter, the appropriate limit value specified in Table 2 shall not be exceeded.

4.7.2 Conditions for Burn-in

The requirements for burn-in are specified in Section 7 of ESCC Generic Specification No. 3501. The conditions for burn-in shall be as specified in Table 5 of this specification.

4.7.3 Electrical Circuits for Burn-in (Figure 5)

Not applicable.



TABLE 2 - ELECTRICAL MEASUREMENTS AT REFERENCE TEMPERATURE

No.	Characteristics	Symbol	ESCC 3501 Test Method	Limits	Unit
1	Resonance frequency at reference temperature and rated drive level - with C _O - with C _L	$f_r(T_o, P_o)$ $f_L(T_o, P_o)$	Para. 9.2.1.1	Table 1(a), Item 1 ± Item 6	MHz
2	Resonance resistance at reference temperature and rated drive level - with C _O - with C _L	$R_r(T_o, P_o)$ $R_L(T_o, P_o)$	Para. 9.2.1.1	Table 1(a), Item 7	Ω
3	Frequency variation with Drive Level	$\frac{\Delta f}{f}(T_o, \Delta P)$	Para. 9.2.1.1	Table 1(a), Item 11	10 ⁻⁶
4	Resistance variation with Drive Level	$\frac{\Delta R}{R}(T_o, \Delta P)$	Para. 9.2.1.1	Table 1(a), Item 12	%
5	Motional Inductance	L ₁	Para. 9.2.1.3	Table 1(a), Item 13	mH
6	Static Capacitance	C _o	Para. 9.2.1.4	Table 1(a), Item 15	pF
7	Unwanted response	R _p /R or Z _{pl} /R	Para. 9.2.1.5	Table 1(a), Item 17	-
8	Insulation Resistance	R _i	Para. 9.2.1.6	500 Min.	MΩ

TABLE 3 - ELECTRICAL MEASUREMENTS AT HIGH AND LOW TEMPERATURES

No.	Characteristics	Symbol	ESCC 3501 Test Method	Limits	Unit
9	Frequency variation with Temperature over T_{op}	$\frac{\Delta f}{f} (\Delta T, P_o)$	Para. 9.2.1.2	Table 1(a) Item 8	10^{-6}
10	Resistance variation with Temperature over T_{op}	$\frac{\Delta R}{R} (\Delta T, P_o)$	Para. 9.2.1.2	Table 1(a) Item 9	%

FIGURE 4 - CIRCUITS FOR ELECTRICAL MEASUREMENTS

Not applicable.

TABLE 4 - PARAMETER DRIFT VALUES

No.	Characteristics	Symbol	Spec. and/or Test Method	Test Conditions	Change Limits (Δ)	Unit
1	Resonance frequency drift	$\frac{\Delta f}{f}$	As per Table 2	As per Table 2	± 2.0	10^{-6}
2	Resonance resistance drift	$\frac{\Delta R}{R}$	As per Table 2	As per Table 2	± 10 or (1) ± 1.0	%

NOTES 1. Whichever is the highest value.

TABLE 5 - CONDITIONS FOR BURN-IN AND LIFE TEST

No.	Characteristics	Symbol	Condition	Unit
1	Ambient Temperature	T_{amb}	$+85 \pm 5$	$^{\circ}C$

FIGURE 5 - ELECTRICAL CIRCUIT FOR BURN-IN AND LIFE TEST

Not applicable.

	ESCC Detail Specification No. 3501/001		PAGE 19 ISSUE 4
--	---	--	--------------------

4.8 ENVIRONMENTAL AND ENDURANCE TESTS (CHARTS IV AND V OF ESCC GENERIC SPECIFICATION NO. 3501)

4.8.1 Measurements and Inspections on Completion of Environmental Tests

The parameters to be measured and inspections to be performed on completion of environmental tests are scheduled in Table 6. Unless otherwise stated, the measurements shall be performed at $T_{amb} = T_o \pm 2 \text{ }^\circ\text{C}$.

4.8.2 Measurements and Inspections at Intermediate Points and on Completion of Endurance Tests

The parameters to be measured and inspections to be performed at intermediate points and on completion of endurance tests are scheduled in Table 6. Unless otherwise stated, the measurements shall be performed at $T_{amb} = T_o \pm 2 \text{ }^\circ\text{C}$.

4.8.3 Conditions for Operating Life Test (Part of Endurance Testing)

The requirements for the operating life test are specified in Section 9 of ESCC Generic Specification No. 3501. The test shall be performed as a high temperature storage test and the temperature to be applied shall be the maximum operating temperature specified in the individual Tables 1(a) given in this specification.



TABLE 6 - MEASUREMENTS AND INSPECTIONS ON COMPLETION OF ENVIRONMENTAL TESTS AND AT INTERMEDIATE POINTS AND ON COMPLETION OF ENDURANCE TESTING

NO.	ESCC GENERIC SPEC. NO. 3501		MEASUREMENTS AND INSPECTIONS		SYMBOL	LIMITS		UNIT
	ENVIRONMENTAL AND ENDURANCE TESTS (1)	TEST METHOD AND CONDITIONS	IDENTIFICATION	CONDITIONS		Min.	Max.	
01	Electrical Measurements at Reference Temperature	Para. 9.2.4	Electrical Measurements	Table 2		Table 1(a)		
02	Shock	Para. 9.3	Initial Measurements Resonance Frequency Resonance Resistance Final Measurements Resonance Frequency Drift Resonance Resistance Drift	Table 2 Item 1 Table 2 Item 2 Table 2 Item 1 Table 2 Item 2	f R $\frac{\Delta f}{f}$ $\frac{\Delta R}{R}$ ΔR	- 1.0 + 1.0 - 10 or (2) - 1.0	+ 1.0 + 1.0	10 ⁻⁶ % Ω
03	Vibration	Para. 9.4	Initial Measurements Resonance Frequency Resonance Resistance Final Measurements Resonance Frequency Drift Resonance Resistance Drift	Table 2 Item 1 Table 2 Item 2 Table 2 Item 1 Table 2 Item 2	f R $\frac{\Delta f}{f}$ $\frac{\Delta R}{R}$ ΔR	- 1.0 + 1.0 - 10 or (2) - 1.0	+ 1.0 + 1.0	10 ⁻⁶ % Ω
04	Seal Test	Para. 9.5	Fine Leak Gross Leak	Para. 9.5.1 Para. 9.5.2		Para. 9.5.1 Para. 9.5.2		
05	Permanence of Marking	Para. 9.8	Final Measurements Visual Examination	No corrosion or obliteration of marking	-	-	-	-
06	External Visual Inspection	Para. 9.9	Final Measurements Visual Inspection	ESCC No. 20500	-	-	-	-
07	Solderability	Para. 9.13			-	-	-	-

NOTES

1. The tests in this table refer to either Chart IV or V, and shall be used as applicable.
2. Whichever is the highest value.

TABLE 6 - MEASUREMENTS AND INSPECTIONS ON COMPLETION OF ENVIRONMENTAL TESTS AND AT INTERMEDIATE POINTS AND ON COMPLETION OF ENDURANCE TESTING (Cont.)

NO.	ESCC GENERIC SPEC. NO. 3501		MEASUREMENTS AND INSPECTIONS		SYMBOL	LIMITS		UNIT
	ENVIRONMENTAL AND ENDURANCE TESTS (1)	TEST METHOD AND CONDITIONS	IDENTIFICATION	CONDITIONS		Min.	Max.	
08	Climatic Sequence Dry Heat	Para. 9.14 Para. 9.14.1	Initial Measurements		f			
			Resonance Frequency	Table 2 Item 1	f			
			Resonance Resistance	Table 2 Item 2	R			
			Final Measurements					
09	Cold	Para. 9.14.3	Resonance Frequency	Table 2 Item 1	$\frac{\Delta f}{f}$	-2.0	+2.0	10 ⁻⁶
			Drift		f			
			Resonance Resistance	Table 2 Item 2	$\frac{\Delta R}{R}$	-10	+10	%
			Drift		R			
10	Damp Heat (Accelerated) Remaining Cycles	Para. 9.14.4	Initial Measurements		ΔR	-1.0	+1.0	Ω
			Resonance Frequency	Table 2 Item 1	f			
			Resonance Resistance	Table 2 Item 2	R			
			Final Measurements					
11	Rapid Change of Temperature	Para. 9.15	Resonance Frequency	Table 2 Item 1	$\frac{\Delta f}{f}$	-2.0	+2.0	10 ⁻⁶
			Drift		f			
			Resonance Resistance	Table 2 Item 2	$\frac{\Delta R}{R}$	-10	+10	%
			Drift		R			
12	Robustness of Terminations	Para. 9.16	Tensile Strength	Gen. 3501 Para. 9.16.1				
			Visual Examination Bending	No visible damage Gen. 3501 Para. 9.16.2				
			Visual Examination	No visible damage				
			Insulation Resistance	Table 2 Item 8	R _i	500	-	M Ω

NOTES

1. The tests in this table refer to either Chart IV or V, and shall be used as applicable.
2. Whichever is the highest value.



TABLE 6 - MEASUREMENTS AND INSPECTIONS ON COMPLETION OF ENVIRONMENTAL TESTS AND AT INTERMEDIATE POINTS AND ON COMPLETION OF ENDURANCE TESTING (Cont.)

NO.	ESCC GENERIC SPEC. NO. 3501		MEASUREMENTS AND INSPECTIONS		SYMBOL	LIMITS		UNIT
	ENVIRONMENTAL AND ENDURANCE TESTS (1)	TEST METHOD AND CONDITIONS	IDENTIFICATION	CONDITIONS		Min.	Max.	
13	Life Test	Para. 9.17	Initial Measurements					
			Resonance Frequency	Table 2 Item 1	f	Table 2 Item 1		
			Resonance Resistance	Table 2 Item 2	R	Table 2 Item 2		
			Intermediate Measurements	At 500 hours				
			Resonance Frequency	Table 2 Item 1	$\frac{\Delta f}{f}$	-2.0	+2.0	10^{-6}
			Drift		f			
			Resonance Resistance	Table 2 Item 2	$\frac{\Delta R}{R}$	-10	+10	%
			Drift		R	or (2)		
					ΔR	-1.0	+1.0	Ω
			Intermediate Measurements (Chart IV) and Final Measurements (Chart V)	At 1000 hours				
			Resonance Frequency	Table 2 Item 1	$\frac{\Delta f}{f}$	-2.5	+2.5	10^{-6}
			Drift		f			
			Resonance Resistance	Table 2 Item 2	$\frac{\Delta R}{R}$	-10	+10	%
Drift		R	or (2)					
		ΔR	-1.0	+1.0	Ω			
Final Measurements (Chart IV)	At 2000 hours							
Resonance Frequency	Table 2 Item 1	$\frac{\Delta f}{f}$	-3.0	+3.0	10^{-6}			
Drift		f						
Resonance Resistance	Table 2 Item 2	$\frac{\Delta R}{R}$	-10	+10	%			
Drift		R	or (2)					
		ΔR	-1.0	+1.0	Ω			

NOTES

1. The tests in this table refer to either Chart IV or V, and shall be used as applicable.
2. Whichever is the highest value.

TABLE 1(a) - TYPE VARIANT DETAILED INFORMATION
TYPE VARIANT NO. 01

No.	Characteristics	Symbol	Limits		Unit	Remarks
			Min.	Max.		
1	Resonance Frequency	f_r	65.34375		MHz	Swept
2	Reference Temperature	T_o	+23	+27	°C	
3	Overtone Order	-	3			
4	Load Capacitance	C_L	∞		pF	
5	Rated Drive Level	P_o	0.1		mW	
6	Frequency Adjustment Tolerance	$\frac{\Delta f}{f}$	-10	+10	10^{-6}	At T_o °C
7	Resonance Resistance	R_r	-	40	Ω	At T_o °C
8	Frequency Variation with Temperature over T_{op}	$\frac{\Delta f}{f}$	-7.5	+7.5	10^{-6}	From frequency measured at T_o °C
9	Resistance Variation with Temperature over T_{op}	$\frac{\Delta R}{R}$	-10	+10	%	From resistance measured at T_o °C
10	Operating Temperature Range	T_{op}	-20	+70	°C	
11	Frequency variation with Drive Level	$\frac{\Delta f}{f}$	Not applicable		10^{-6}	
12	Resistance variation with Drive Level	$\frac{\Delta R}{R}$	Not applicable		%	
13	Motional Inductance	L_1	3.2	4.8	mH	
14	Motional Capacitance	C_1	Not applicable		fF	
15	Static Capacitance	C_o	-	7.0	pF	
16	Q Factor	Q	Not applicable		-	
17	Ratio of Unwanted: Response Resistance to Resonance Resistance or Response Impedance to Resonance Resistance	R_p/R or $ Z_p /R$	2:1	-		In the frequency range: $f_r - 50\text{kHz}$ to $f_r + 50\text{kHz}$
18	Ageing	$\frac{\Delta f}{f}$	-3.0	+3.0	10^{-6}	After burn-in and per year
19	Terminal Length	L	Figure 2		mm	

TABLE 1(a) - TYPE VARIANT DETAILED INFORMATION

TYPE VARIANT NO. 02

No.	Characteristics	Symbol	Limits		Unit	Remarks
			Min.	Max.		
1	Resonance Frequency	f_r	68.4373		MHz	Swept
2	Reference Temperature	T_o	+23	+27	°C	
3	Overtone Order	-	3			
4	Load Capacitance	C_L	∞		pF	
5	Rated Drive Level	P_o	0.1		mW	
6	Frequency Adjustment Tolerance	$\frac{\Delta f}{f}$	-10	+10	10^{-6}	At T_o °C
7	Resonance Resistance	R_r	-	40	Ω	At T_o °C
8	Frequency Variation with Temperature over T_{op}	$\frac{\Delta f}{f}$	-7.5	+7.5	10^{-6}	From frequency measured at T_o °C
9	Resistance Variation with Temperature over T_{op}	$\frac{\Delta R}{R}$	-10	+10	%	From resistance measured at T_o °C
10	Operating Temperature Range	T_{op}	-20	+70	°C	
11	Frequency variation with Drive Level	$\frac{\Delta f}{f}$	Not applicable		10^{-6}	
12	Resistance variation with Drive Level	$\frac{\Delta R}{R}$	Not applicable		%	
13	Motional Inductance	L_1	3.2	4.8	mH	
14	Motional Capacitance	C_1	Not applicable		fF	
15	Static Capacitance	C_o	-	7.0	pF	
16	Q Factor	Q	Not applicable		-	
17	Ratio of Unwanted: Response Resistance to Resonance Resistance or Response Impedance to Resonance Resistance	R_p/R iZ_p/R	2:1	-		In the frequency range: $f_r - 50\text{kHz}$ to $f_r + 50\text{kHz}$
18	Ageing	$\frac{\Delta f}{f}$	-3.0	+3.0	10^{-6}	After burn-in, and per year
19	Terminal Length	L	Figure 2		mm	

TABLE 1(a) - TYPE VARIANT DETAILED INFORMATION
 TYPE VARIANT NO. 03

No.	Characteristics	Symbol	Limits		Unit	Remarks
			Min.	Max.		
1	Resonance Frequency	f_r	71.9686		MHz	Swept
2	Reference Temperature	T_0	+23	+27	°C	
3	Overtone Order	-	3			
4	Load Capacitance	C_L	∞		pF	
5	Rated Drive Level	P_0	0.1		mW	
6	Frequency Adjustment Tolerance	$\frac{\Delta f}{f}$	-10	+10	10^{-6}	At T_0 °C
7	Resonance Resistance	R_r	-	40	Ω	At T_0 °C
8	Frequency Variation with Temperature over T_{op}	$\frac{\Delta f}{f}$	-7.5	+7.5	10^{-6}	From frequency measured at T_0 °C
9	Resistance Variation with Temperature over T_{op}	$\frac{\Delta R}{R}$	-10	+10	%	From resistance measured at T_0 °C
10	Operating Temperature Range	T_{op}	-20	+70	°C	
11	Frequency variation with Drive Level	$\frac{\Delta f}{f}$	Not applicable		10^{-6}	
12	Resistance variation with Drive Level	$\frac{\Delta R}{R}$	Not applicable		%	
13	Motional Inductance	L_1	3.2	4.8	mH	
14	Motional Capacitance	C_1	Not applicable		fF	
15	Static Capacitance	C_0	-	7.0	pF	
16	Q Factor	Q	Not applicable		-	
17	Ratio of Unwanted: Response Resistance to Resonance Resistance or Response Impedance to Resonance Resistance	R_p/R or iZ_p/R	2:1	-		In the frequency range: $f_r - 50\text{kHz}$ to $f_r + 50\text{kHz}$
18	Ageing	$\frac{\Delta f}{f}$	-3.0	+3.0	10^{-6}	After burn-in, and per year
19	Terminal Length	L	Figure 2		mm	

TABLE 1(a) - TYPE VARIANT DETAILED INFORMATION

TYPE VARIANT NO. 04

No.	Characteristics	Symbol	Limits		Unit	Remarks
			Min.	Max.		
1	Resonance Frequency	f_r	82.53		MHz	Swept
2	Reference Temperature	T_0	+23	+27	°C	
3	Overtone Order	-	3			
4	Load Capacitance	C_L	∞		pF	
5	Rated Drive Level	P_0	0.1		mW	
6	Frequency Adjustment Tolerance	$\frac{\Delta f}{f}$	-5.0	+5.0	10^{-6}	At T_0 °C
7	Resonance Resistance	R_r	-	40	Ω	At T_0 °C
8	Frequency Variation with Temperature over T_{op}	$\frac{\Delta f}{f}$	-10	+10	10^{-6}	From frequency measured at T_0 °C
9	Resistance Variation with Temperature over T_{op}	$\frac{\Delta R}{R}$	-20	+20	%	From resistance measured at T_0 °C
10	Operating Temperature Range	T_{op}	-20	+70	°C	
11	Frequency variation with Drive Level	$\frac{\Delta f}{f}$	Not applicable		10^{-6}	
12	Resistance variation with Drive Level	$\frac{\Delta R}{R}$	Not applicable		%	
13	Motional Inductance	L_1	Not applicable		mH	
14	Motional Capacitance	C_1	Not applicable		fF	
15	Static Capacitance	C_0	-	7.0	pF	
16	Q Factor	Q	Not applicable		-	
17	Ratio of Unwanted: Response Resistance to Resonance Resistance or Response Impedance to Resonance Resistance	R_p/R $ Z_p /R$	2:1	-		In the frequency range: $f_r - 50\text{kHz}$ to $f_r + 50\text{kHz}$
18	Ageing	$\frac{\Delta f}{f}$	-3.0	+3.0	10^{-6}	After burn-in, and per year
19	Terminal Length	L	Figure 2		mm	

TABLE 1(a) - TYPE VARIANT DETAILED INFORMATION

TYPE VARIANT NO. 05

No.	Characteristics	Symbol	Limits		Unit	Remarks
			Min.	Max.		
1	Resonance Frequency	f_r	83.07		MHz	Swept
2	Reference Temperature	T_0	+23	+27	°C	
3	Overtone Order	-	3			
4	Load Capacitance	C_L	∞		pF	
5	Rated Drive Level	P_0	0.1		mW	
6	Frequency Adjustment Tolerance	$\frac{\Delta f}{f}$	-5.0	+5.0	10^{-6}	At T_0 °C
7	Resonance Resistance	R_r	-	40	Ω	At T_0 °C
8	Frequency Variation with Temperature over T_{op}	$\frac{\Delta f}{f}$	-10	+10	10^{-6}	From frequency measured at T_0 °C
9	Resistance Variation with Temperature over T_{op}	$\frac{\Delta R}{R}$	-20	+20	%	From resistance measured at T_0 °C
10	Operating Temperature Range	T_{op}	-20	+70	°C	
11	Frequency variation with Drive Level	$\frac{\Delta f}{f}$	Not applicable		10^{-6}	
12	Resistance variation with Drive Level	$\frac{\Delta R}{R}$	Not applicable		%	
13	Motional Inductance	L_1	Not applicable		mH	
14	Motional Capacitance	C_1	Not applicable		fF	
15	Static Capacitance	C_0	-	7.0	pF	
16	Q Factor	Q	Not applicable		-	
17	Ratio of Unwanted: Response Resistance to Resonance Resistance or Response Impedance to Resonance Resistance	R_p/R $ Z_{pi} /R$	2:1	-		In the frequency range: $f_r - 50\text{kHz}$ to $f_r + 50\text{kHz}$
18	Ageing	$\frac{\Delta f}{f}$	-3.0	+3.0	10^{-6}	After burn-in, and per year
19	Terminal Length	L	Figure 2		mm	

TABLE 1(a) - TYPE VARIANT DETAILED INFORMATION

TYPE VARIANT NO. 06

No.	Characteristics	Symbol	Limits		Unit	Remarks
			Min.	Max.		
1	Resonance Frequency	f_r	83.335		MHz	Swept
2	Reference Temperature	T_o	+23	+27	°C	
3	Overtone Order	-	5			
4	Load Capacitance	C_L	∞		pF	
5	Rated Drive Level	P_o	0.1		mW	
6	Frequency Adjustment Tolerance	$\frac{\Delta f}{f}$	-5.0	+5.0	10^{-6}	At T_o °C
7	Resonance Resistance	R_r	-	60	Ω	At T_o °C
8	Frequency Variation with Temperature over T_{op}	$\frac{\Delta f}{f}$	-7.0	+7.0	10^{-6}	From frequency measured at T_o °C
9	Resistance Variation with Temperature over T_{op}	$\frac{\Delta R}{R}$	-20	+20	%	From resistance measured at T_o °C
10	Operating Temperature Range	T_{op}	-20	+70	°C	
11	Frequency variation with Drive Level	$\frac{\Delta f}{f}$	Not applicable		10^{-6}	
12	Resistance variation with Drive Level	$\frac{\Delta R}{R}$	Not applicable		%	
13	Motional Inductance	L_1	10.8	13.2	mH	
14	Motional Capacitance	C_1	Not applicable		fF	
15	Static Capacitance	C_o	-	7.0	pF	
16	Q Factor	Q	Not applicable		-	
17	Ratio of Unwanted: Response Resistance to Resonance Resistance or Response Impedance to Resonance Resistance	R_p/R or $ Z_p /R$	2:1	-		In the frequency range: $f_r - 50\text{kHz}$ to $f_r + 50\text{kHz}$
18	Ageing	$\frac{\Delta f}{f}$	-5.0	+5.0	10^{-6}	After burn-in, and per year
19	Terminal Length	L	Figure 2		mm	

TABLE 1(a) - TYPE VARIANT DETAILED INFORMATION

TYPE VARIANT NO. 07

No.	Characteristics	Symbol	Limits		Unit	Remarks
			Min.	Max.		
1	Resonance Frequency	f_r	84.210526		MHz	Swept
2	Reference Temperature	T_0	+24	+26	°C	
3	Overtone Order	-	3			
4	Load Capacitance	C_L	∞		pF	
5	Rated Drive Level	P_0	0.1		mW	
6	Frequency Adjustment Tolerance	$\frac{\Delta f}{f}$	-5.0	+5.0	10^{-6}	At T_0 °C
7	Resonance Resistance	R_r	-	40	Ω	At T_0 °C
8	Frequency Variation with Temperature over T_{op}	$\frac{\Delta f}{f}$	-8.0	+8.0	10^{-6}	From frequency measured at T_0 °C
9	Resistance Variation with Temperature over T_{op}	$\frac{\Delta R}{R}$	-20	+20	%	From resistance measured at T_0 °C
10	Operating Temperature Range	T_{op}	-20	+70	°C	
11	Frequency variation with Drive Level	$\frac{\Delta f}{f}$	Not applicable		10^{-6}	
12	Resistance variation with Drive Level	$\frac{\Delta R}{R}$	Not applicable		%	
13	Motional Inductance	L_1	Not applicable		mH	
14	Motional Capacitance	C_1	Not applicable		fF	
15	Static Capacitance	C_0	-	7.0	pF	
16	Q Factor	Q	Not applicable		-	
17	Ratio of Unwanted: Response Resistance to Resonance Resistance or Response Impedance to Resonance Resistance	R_p/R $ Z_{pi} /R$	2:1	-		In the frequency range: $f_r - 50\text{kHz}$ to $f_r + 50\text{kHz}$
18	Ageing	$\frac{\Delta f}{f}$	-3.0	+3.0	10^{-6}	After burn-in, and per year
19	Terminal Length	L	Figure 2		mm	



TABLE 1(a) - TYPE VARIANT DETAILED INFORMATION

TYPE VARIANT NO. 08

No.	Characteristics	Symbol	Limits		Unit	Remarks
			Min.	Max.		
1	Resonance Frequency	f_r	84.868421		MHz	Swept
2	Reference Temperature	T_0	+24	+26	°C	
3	Overtone Order	-	3			
4	Load Capacitance	C_L	∞		pF	
5	Rated Drive Level	P_0	0.1		mW	
6	Frequency Adjustment Tolerance	$\frac{\Delta f}{f}$	-5.0	+5.0	10^{-6}	At T_0 °C
7	Resonance Resistance	R_r	-	40	Ω	At T_0 °C
8	Frequency Variation with Temperature over T_{op}	$\frac{\Delta f}{f}$	-8.0	+8.0	10^{-6}	From frequency measured at T_0 °C
9	Resistance Variation with Temperature over T_{op}	$\frac{\Delta R}{R}$	-20	+20	%	From resistance measured at T_0 °C
10	Operating Temperature Range	T_{op}	-20	+70	°C	
11	Frequency variation with Drive Level	$\frac{\Delta f}{f}$	Not applicable		10^{-6}	
12	Resistance variation with Drive Level	$\frac{\Delta R}{R}$	Not applicable		%	
13	Motional Inductance	L_1	Not applicable		mH	
14	Motional Capacitance	C_1	Not applicable		fF	
15	Static Capacitance	C_0	-	7.0	pF	
16	Q Factor	Q	Not applicable		-	
17	Ratio of Unwanted: Response Resistance to Resonance Resistance or Response Impedance to Resonance Resistance	R_p/R or iZ_p/R	2:1	-		In the frequency range: $f_r - 50\text{kHz}$ to $f_r + 50\text{kHz}$
18	Ageing	$\frac{\Delta f}{f}$	-3.0	+3.0	10^{-6}	After burn-in, over 10 years
19	Terminal Length	L	Figure 2		mm	

TABLE 1(a) - TYPE VARIANT DETAILED INFORMATION

TYPE VARIANT NO. 09

No.	Characteristics	Symbol	Limits		Unit	Remarks
			Min.	Max.		
1	Resonance Frequency	f_r	85.087737		MHz	Swept
2	Reference Temperature	T_o	+24	+26	°C	
3	Overtone Order	-	3			
4	Load Capacitance	C_L	∞		pF	
5	Rated Drive Level	P_o	0.1		mW	
6	Frequency Adjustment Tolerance	$\frac{\Delta f}{f}$	-5.0	+5.0	10^{-6}	At T_o °C
7	Resonance Resistance	R_r	-	40	Ω	At T_o °C
8	Frequency Variation with Temperature over T_{op}	$\frac{\Delta f}{f}$	-8.0	+8.0	10^{-6}	From frequency measured at T_o °C
9	Resistance Variation with Temperature over T_{op}	$\frac{\Delta R}{R}$	-20	+20	%	From resistance measured at T_o °C
10	Operating Temperature Range	T_{op}	-20	+70	°C	
11	Frequency variation with Drive Level	$\frac{\Delta f}{f}$	Not applicable		10^{-6}	
12	Resistance variation with Drive Level	$\frac{\Delta R}{R}$	Not applicable		%	
13	Motional Inductance	L_1	Not applicable		mH	
14	Motional Capacitance	C_1	Not applicable		fF	
15	Static Capacitance	C_o	-	7.0	pF	
16	Q Factor	Q	Not applicable		-	
17	Ratio of Unwanted: Response Resistance to Resonance Resistance or Response Impedance to Resonance Resistance	R_p/R or $ Z_p /R$	2:1	-		In the frequency range: $f_r - 50\text{kHz}$ to $f_r + 50\text{kHz}$
18	Ageing	$\frac{\Delta f}{f}$	-3.0	+3.0	10^{-5}	After burn-in, and per year
19	Terminal Length	L	Figure 2		mm	



TABLE 1(a) - TYPE VARIANT DETAILED INFORMATION

TYPE VARIANT NO. 10

No.	Characteristics	Symbol	Limits		Unit	Remarks
			Min.	Max.		
1	Resonance Frequency	f_r	85.964947		MHz	Swept
2	Reference Temperature	T_0	+24	+26	°C	
3	Overtone Order	-	3			
4	Load Capacitance	C_L	∞		pF	
5	Rated Drive Level	P_0	0.1		mW	
6	Frequency Adjustment Tolerance	$\frac{\Delta f}{f}$	-5.0	+5.0	10^{-6}	At T_0 °C
7	Resonance Resistance	R_r	-	40	Ω	At T_0 °C
8	Frequency Variation with Temperature over T_{op}	$\frac{\Delta f}{f}$	-8.0	+8.0	10^{-6}	From frequency measured at T_0 °C
9	Resistance Variation with Temperature over T_{op}	$\frac{\Delta R}{R}$	-20	+20	%	From resistance measured at T_0 °C
10	Operating Temperature Range	T_{op}	-20	+70	°C	
11	Frequency variation with Drive Level	$\frac{\Delta f}{f}$	Not applicable		10^{-6}	
12	Resistance variation with Drive Level	$\frac{\Delta R}{R}$	Not applicable		%	
13	Motional Inductance	L_1	Not applicable		mH	
14	Motional Capacitance	C_1	Not applicable		fF	
15	Static Capacitance	C_0	-	7.0	pF	
16	Q Factor	Q	Not applicable		-	
17	Ratio of Unwanted: Response Resistance to Resonance Resistance or Response Impedance to Resonance Resistance	R_p/R or iZ_p/R	2:1	-		In the frequency range: $f_r - 50\text{kHz}$ to $f_r + 50\text{kHz}$
18	Ageing	$\frac{\Delta f}{f}$	-3.0	+3.0	10^{-6}	After burn-in, and per year
19	Terminal Length	L	Figure 2		mm	



TABLE 1(a) - TYPE VARIANT DETAILED INFORMATION

TYPE VARIANT NO. 11

No.	Characteristics	Symbol	Limits		Unit	Remarks
			Min.	Max.		
1	Resonance Frequency	f_r	36.866968		MHz	Swept
2	Reference Temperature	T_o	+23	+27	°C	
3	Overtone Order	-	3			
4	Load Capacitance	C_L	∞		pF	
5	Rated Drive Level	P_o	0.1		mW	
6	Frequency Adjustment Tolerance	$\frac{\Delta f}{f}$	-10	+10	10^{-6}	At T_o °C
7	Resonance Resistance	R_r	-	40	Ω	At T_o °C
8	Frequency Variation with Temperature over T_{op}	$\frac{\Delta f}{f}$	-9.0	+9.0	10^{-6}	From frequency measured at T_o °C
9	Resistance Variation with Temperature over T_{op}	$\frac{\Delta R}{R}$	-10	+10	%	From resistance measured at T_o °C
10	Operating Temperature Range	T_{op}	-20	+70	°C	
11	Frequency variation with Drive Level	$\frac{\Delta f}{f}$	Not applicable		10^{-6}	
12	Resistance variation with Drive Level	$\frac{\Delta R}{R}$	Not applicable		%	
13	Motional Inductance	L_1	17.7	21.7	mH	
14	Motional Capacitance	C_1	Not applicable		fF	
15	Static Capacitance	C_o	-	7.0	pF	
16	Q Factor	Q	Not applicable		-	
17	Ratio of Unwanted: Response Resistance to Resonance Resistance or Response Impedance to Resonance Resistance	R_p/R or $ Z_p /R$	2:1	-		In the frequency range: $f_r - 50\text{kHz}$ to $f_r + 50\text{kHz}$
18	Ageing	$\frac{\Delta f}{f}$	-3.0	+3.0	10^{-6}	After burn-in, and per year
19	Terminal Length	L	Figure 2		mm	



TABLE 1(a) - TYPE VARIANT DETAILED INFORMATION
TYPE VARIANT NO. 12

No.	Characteristics	Symbol	Limits		Unit	Remarks
			Min.	Max.		
1	Resonance Frequency	f_r	37.166667		MHz	Swept
2	Reference Temperature	T_o	+23	+27	°C	
3	Overtone Order	-	3			
4	Load Capacitance	C_L	∞		pF	
5	Rated Drive Level	P_o	0.1		mW	
6	Frequency Adjustment Tolerance	$\frac{\Delta f}{f}$	-10	+10	10^{-6}	At T_o °C
7	Resonance Resistance	R_r	-	40	Ω	At T_o °C
8	Frequency Variation with Temperature over T_{op}	$\frac{\Delta f}{f}$	-9.0	+9.0	10^{-6}	From frequency measured at T_o °C
9	Resistance Variation with Temperature over T_{op}	$\frac{\Delta R}{R}$	-10	+10	%	From resistance measured at T_o °C
10	Operating Temperature Range	T_{op}	-20	+70	°C	
11	Frequency variation with Drive Level	$\frac{\Delta f}{f}$	Not applicable		10^{-6}	
12	Resistance variation with Drive Level	$\frac{\Delta R}{R}$	Not applicable		%	
13	Motional Inductance	L_1	17.3	21.3	mH	
14	Motional Capacitance	C_1	Not applicable		fF	
15	Static Capacitance	C_o	-	7.0	pF	
16	Q Factor	Q	Not applicable		-	
17	Ratio of Unwanted: Response Resistance to Resonance Resistance or Response Impedance to Resonance Resistance	R_p/R $ Z_p /R$	2:1	-		In the frequency range: $f_r - 50\text{kHz}$ to $f_r + 50\text{kHz}$
18	Ageing	$\frac{\Delta f}{f}$	-3.0	+3.0	10^{-6}	After burn-in, and per year
19	Terminal Length	L	Figure 2		mm	

TABLE 1(a) - TYPE VARIANT DETAILED INFORMATION

TYPE VARIANT NO. 13

No.	Characteristics	Symbol	Limits		Unit	Remarks
			Min.	Max.		
1	Resonance Frequency	f_r	62.052865		MHz	Swept
2	Reference Temperature	T_o	+23	+27	°C	
3	Overtone Order	-	3			
4	Load Capacitance	C_L	∞		pF	
5	Rated Drive Level	P_o	0.1		mW	
6	Frequency Adjustment Tolerance	$\frac{\Delta f}{f}$	-10	+10	10^{-6}	At T_o °C
7	Resonance Resistance	R_r	-	40	Ω	At T_o °C
8	Frequency Variation with Temperature over T_{op}	$\frac{\Delta f}{f}$	-9.0	+9.0	10^{-6}	From frequency measured at T_o °C
9	Resistance Variation with Temperature over T_{op}	$\frac{\Delta R}{R}$	-10	+10	%	From resistance measured at T_o °C
10	Operating Temperature Range	T_{op}	-20	+70	°C	
11	Frequency variation with Drive Level	$\frac{\Delta f}{f}$	Not applicable		10^{-6}	
12	Resistance variation with Drive Level	$\frac{\Delta R}{R}$	Not applicable		%	
13	Motional Inductance	L_1	3.2	4.8	mH	
14	Motional Capacitance	C_1	Not applicable		fF	
15	Static Capacitance	C_o	-	7.0	pF	
16	Q Factor	Q	30 000	-	-	
17	Ratio of Unwanted: Response Resistance to Resonance Resistance or Response Impedance to Resonance Resistance	R_p/R or $ Z_{pl}/R$	2:1	-		In the frequency range: $f_r - 50\text{kHz}$ to $f_r + 50\text{kHz}$
18	Ageing	$\frac{\Delta f}{f}$	-3.0	+3.0	10^{-6}	After burn-in, and per year
19	Terminal Length	L	Figure 2		mm	

TABLE 1(a) - TYPE VARIANT DETAILED INFORMATION

TYPE VARIANT NO. 14

No.	Characteristics	Symbol	Limits		Unit	Remarks
			Min.	Max.		
1	Resonance Frequency	f_r	70.0		MHz	
2	Reference Temperature	T_0	+23	+27	°C	
3	Overtone Order	-	3			
4	Load Capacitance	C_L	∞		pF	
5	Rated Drive Level	P_0	0.1		mW	
6	Frequency Adjustment Tolerance	$\frac{\Delta f}{f}$	-10	+10	10^{-6}	At T_0 °C
7	Resonance Resistance	R_r	-	40	Ω	At T_0 °C
8	Frequency Variation with Temperature over T_{op}	$\frac{\Delta f}{f}$	-9.0	+9.0	10^{-6}	From frequency measured at T_0 °C
9	Resistance Variation with Temperature over T_{op}	$\frac{\Delta R}{R}$	-10	+10	%	From resistance measured at T_0 °C
10	Operating Temperature Range	T_{op}	-20	+70	°C	
11	Frequency variation with Drive Level	$\frac{\Delta f}{f}$	Not applicable		10^{-6}	
12	Resistance variation with Drive Level	$\frac{\Delta R}{R}$	Not applicable		%	
13	Motional Inductance	L_1	3.2	4.8	mH	
14	Motional Capacitance	C_1	Not applicable		fF	
15	Static Capacitance	C_0	-	7.0	pF	
16	Q Factor	Q	35 000	-	-	
17	Ratio of Unwanted: Response Resistance to Resonance Resistance or Response Impedance to Resonance Resistance	R_p/R or $ Z_p /R$	2:1	-		In the frequency range: $f_r - 50\text{kHz}$ to $f_r + 50\text{kHz}$
18	Ageing	$\frac{\Delta f}{f}$	-3.0	+3.0	10^{-6}	After burn-in, and per year
19	Terminal Length	L	Figure 2		mm	



TABLE 1(a) - TYPE VARIANT DETAILED INFORMATION

TYPE VARIANT NO. 15

No.	Characteristics	Symbol	Limits		Unit	Remarks
			Min.	Max.		
1	Resonance Frequency	f_L	102.0833333		MHz	
2	Reference Temperature	T_0	+22	+28	°C	
3	Overtone Order	-	5			
4	Load Capacitance	C_L	11.9	12.1	pF	
5	Rated Drive Level	P_0	0.1		mW	
6	Frequency Adjustment Tolerance	$\frac{\Delta f}{f}$	-5.0	+5.0	10^{-6}	At T_0 °C
7	Resonance Resistance	R_L	-	70	Ω	Over T_{op} °C
8	Frequency Variation with Temperature over T_{op}	$\frac{\Delta f}{f}$	-5.0	+5.0	10^{-6}	From frequency measured at T_0 °C
9	Resistance Variation with Temperature over T_{cp}	$\frac{\Delta R}{R}$	Not applicable		%	
10	Operating Temperature Range	T_{op}	-20	+50	°C	
11	Frequency variation with Drive Level	$\frac{\Delta f}{f}$	Not applicable		10^{-6}	
12	Resistance variation with Drive Level	$\frac{\Delta R}{R}$	Not applicable		%	
13	Motional Inductance	L_1	Not applicable		mH	
14	Motional Capacitance	C_1	-	0.37	fF	
15	Static Capacitance	C_0	-	3.0	pF	
16	Q Factor	Q	60 000	-	-	
17	Ratio of Unwanted: Response Resistance to Resonance Resistance or Response Impedance to Resonance Resistance	R_p/R or $ Z_p /R$	3:1	-		In the frequency range: $f_L - 100\text{kHz}$ to $f_L + 100\text{kHz}$
18	Ageing	$\frac{\Delta f}{f}$	-10	+10	10^{-6}	After burn-in, over 10 years
19	Terminal Length	L	Figure 2		mm	



TABLE 1(a) - TYPE VARIANT DETAILED INFORMATION

TYPE VARIANT NO. 16

No.	Characteristics	Symbol	Limits		Unit	Remarks
			Min.	Max.		
1	Resonance Frequency	f_L	15.0		MHz	
2	Reference Temperature	T_o	+ 40		°C	
3	Overtone Order	-	Fundamental			
4	Load Capacitance	C_L	50		pF	
5	Rated Drive Level	P_o	0.1		mW	
6	Frequency Adjustment Tolerance	$\frac{\Delta f}{f}$	-10	+ 10	10^{-6}	At T_o °C
7	Resonance Resistance	R_L	-	13	Ω	Over T_{op} °C
8	Frequency Variation with Temperature over T_{op}	$\frac{\Delta f}{f}$	-15	+ 15	10^{-6}	From frequency measured at T_o °C
9	Resistance Variation with Temperature over T_{op}	$\frac{\Delta R}{R}$	Not applicable		%	
10	Operating Temperature Range	T_{op}	-20	+ 80	°C	
11	Frequency variation with Drive Level	$\frac{\Delta f}{f}$	Not applicable		10^{-6}	
12	Resistance variation with Drive Level	$\frac{\Delta R}{R}$	Not applicable		%	
13	Motional Inductance	L_1	Not applicable		mH	
14	Motional Capacitance	C_1	Not applicable		fF	
15	Static Capacitance	C_o	Not applicable		pF	
16	Q Factor	Q	50 000	-	-	
17	Ratio of Unwanted: Response Resistance to Resonance Resistance or Response Impedance to Resonance Resistance	R_p/R or $ Z_p /R$	3:1	-		In the frequency range: $f_L - 200\text{kHz}$ to $f_L + 200\text{kHz}$
18	Ageing	$\frac{\Delta f}{f}$	-3.0	+ 3.0	10^{-6}	
19	Terminal Length	L	Figure 2		mm	



TABLE 1(a) - TYPE VARIANT DETAILED INFORMATION

TYPE VARIANT NO. 17

No.	Characteristics	Symbol	Limits		Unit	Remarks
			Min.	Max.		
1	Resonance Frequency	f_L	16.0		MHz	
2	Reference Temperature	T_0	+60		°C	
3	Overtone Order	-	Fundamental			
4	Load Capacitance	C_L	20	50	pF	
5	Rated Drive Level	P_0	0.1		mW	
6	Frequency Adjustment Tolerance	$\frac{\Delta f}{f}$	-10	+10	10^{-6}	At T_0 °C
7	Resonance Resistance	R_L	-	20	Ω	At T_0 °C
8	Frequency Variation with Temperature over T_{op}	$\frac{\Delta f}{f}$	-10	+10	10^{-6}	From frequency measured at T_0 °C
9	Resistance Variation with Temperature over T_{op}	$\frac{\Delta R}{R}$	-10 or -1.5	+10 +1.5	% Ω	From resistance measured at T_0 °C if $R < 100\Omega$
10	Operating Temperature Range	T_{op}	-30	+70	°C	
11	Frequency variation with Drive Level	$\frac{\Delta f}{f}$	Not applicable		10^{-6}	
12	Resistance variation with Drive Level	$\frac{\Delta R}{R}$	Not applicable		%	
13	Motional Inductance	L_1	9.5		mH	
14	Motional Capacitance	C_1	Not applicable		fF	
15	Static Capacitance	C_0	-	7.0	pF	
16	Q Factor	Q	70 000	-	-	
17	Ratio of Unwanted: Response Resistance to Resonance Resistance or Response Impedance to Resonance Resistance	R_p/R or $ Z_p /R$	2:1	-		In the frequency range: $f_L - 200\text{kHz}$ to $f_L + 200\text{kHz}$
18	Ageing	$\frac{\Delta f}{f}$	-10	+10	10^{-6}	After burn-in, and per year
19	Terminal Length	L	Figure 2		mm	

TABLE 1(a) - TYPE VARIANT DETAILED INFORMATION

TYPE VARIANT NO. 18

No.	Characteristics	Symbol	Limits		Unit	Remarks
			Min.	Max.		
1	Resonance Frequency	f_L	15.84		MHz	
2	Reference Temperature	T_0	+25		°C	
3	Overtone Order	-	Fundamental			
4	Load Capacitance	C_L	50		pF	
5	Rated Drive Level	P_0	0.1		mW	
6	Frequency Adjustment Tolerance	$\frac{\Delta f}{f}$	-20	+20	10^{-6}	At T_0 °C
7	Resonance Resistance	R_L	-	20	Ω	Over T_{op} °C
8	Frequency Variation with Temperature over T_{op}	$\frac{\Delta f}{f}$	-30	+30	10^{-6}	From frequency measured at T_0 °C
9	Resistance Variation with Temperature over T_{op}	$\frac{\Delta R}{R}$	Not applicable		%	
10	Operating Temperature Range	T_{op}	-55	+105	°C	
11	Frequency variation with Drive Level	$\frac{\Delta f}{f}$	Not applicable		10^{-6}	
12	Resistance variation with Drive Level	$\frac{\Delta R}{R}$	Not applicable		%	
13	Motional Inductance	L_1	12.24	16.56	mH	
14	Motional Capacitance	C_1	Not applicable		fF	
15	Static Capacitance	C_0	-	5.0	pF	
16	Q Factor	Q	70 000	-	-	
17	Ratio of Unwanted: Response Resistance to Resonance Resistance or Response Impedance to Resonance Resistance	R_p/R $ Z_p /R$	3:1	-		In the frequency range: $f_L - 1.0\text{MHz}$ to $f_L + 1.0\text{MHz}$
18	Ageing	$\frac{\Delta f}{f}$	-7.5	+7.5	10^{-6}	After burn-in, and per year
19	Terminal Length	L	Figure 2		mm	

TABLE 1(a) - TYPE VARIANT DETAILED INFORMATION

TYPE VARIANT NO. 19

No.	Characteristics	Symbol	Limits		Unit	Remarks
			Min.	Max.		
1	Resonance Frequency	f_L	16.0 -16.384		MHz	
2	Reference Temperature	T_0	+60		°C	
3	Overtone Order	-	Fundamental			
4	Load Capacitance	C_L	22		pF	
5	Rated Drive Level	P_0	0.1		mW	
6	Frequency Adjustment Tolerance	$\frac{\Delta f}{f}$	-10	+10	10^{-6}	At T_0 °C
7	Resonance Resistance	R_L	-	20	Ω	Over T_{op} °C
8	Frequency Variation with Temperature over T_{op}	$\frac{\Delta f}{f}$	-15	+15	10^{-6}	From frequency measured at T_0 °C
9	Resistance Variation with Temperature over T_{op}	$\frac{\Delta R}{R}$	Not applicable		%	
10	Operating Temperature Range	T_{op}	-20	+70	°C	
11	Frequency variation with Drive Level	$\frac{\Delta f}{f}$	Not applicable		10^{-6}	
12	Resistance variation with Drive Level	$\frac{\Delta R}{R}$	Not applicable		%	
13	Motional Inductance	L_1	Not applicable		mH	
14	Motional Capacitance	C_1	Not applicable		fF	
15	Static Capacitance	C_0	-	5.0	pF	
16	Q Factor	Q	Not applicable		-	
17	Ratio of Unwanted: Response Resistance to Resonance Resistance or Response Impedance to Resonance Resistance	R_p/R $ Z_{pl}/R$	3:1	-		In the frequency range: $f_L - 200\text{kHz}$ to $f_L + 200\text{kHz}$
18	Ageing	$\frac{\Delta f}{f}$	-3.0	+3.0	10^{-6}	After burn-in, and per year
19	Terminal Length	L	Figure 2		mm	



TABLE 1(a) - TYPE VARIANT DETAILED INFORMATION

TYPE VARIANT NO. 20

No.	Characteristics	Symbol	Limits		Unit	Remarks
			Min.	Max.		
1	Resonance Frequency	f_L	16.35		MHz	
2	Reference Temperature	T_o	+25		°C	
3	Overtone Order	-	Fundamental			
4	Load Capacitance	C_L	30		pF	
5	Rated Drive Level	P_o	0.1		mW	
6	Frequency Adjustment Tolerance	$\frac{\Delta f}{f}$	-15	+15	10^{-6}	At T_o °C
7	Resonance Resistance	R_L	-	30	Ω	Over T_{op} °C
8	Frequency Variation with Temperature over T_{op}	$\frac{\Delta f}{f}$	-15	+15	10^{-6}	From frequency measured at T_o °C
9	Resistance Variation with Temperature over T_{op}	$\frac{\Delta R}{R}$	Not applicable		%	
10	Operating Temperature Range	T_{op}	-20	+70	°C	
11	Frequency variation with Drive Level	$\frac{\Delta f}{f}$	Not applicable		10^{-6}	
12	Resistance variation with Drive Level	$\frac{\Delta R}{R}$	Not applicable		%	
13	Motional Inductance	L_1	Not applicable		mH	
14	Motional Capacitance	C_1	Not applicable		fF	
15	Static Capacitance	C_o	-	4.0	pF	
16	Q Factor	Q	Not applicable		-	
17	Ratio of Unwanted: Response Resistance to Resonance Resistance or Response Impedance to Resonance Resistance	R_p/R or $ Z_p /R$	2:1	-		In the frequency range: $f_L - 1.0\text{MHz}$ to $f_L + 1.0\text{MHz}$
18	Ageing	$\frac{\Delta f}{f}$	-5.0	+5.0	10^{-6}	After burn-in, and per year
19	Terminal Length	L	Figure 2		mm	



TABLE 1(a) - TYPE VARIANT DETAILED INFORMATION

TYPE VARIANT NO. 21

No.	Characteristics	Symbol	Limits		Unit	Remarks
			Min.	Max.		
1	Resonance Frequency	f_r	18.84		MHz	
2	Reference Temperature	T_o	+25		°C	
3	Overtone Order	-	Fundamental			
4	Load Capacitance	C_L	∞		pF	
5	Rated Drive Level	P_o	0.1		mW	
6	Frequency Adjustment Tolerance	$\frac{\Delta f}{f}$	-5.0	+5.0	10^{-6}	At T_o °C
7	Resonance Resistance	R_r	-	17.5	Ω	At T_o °C
8	Frequency Variation with Temperature over T_{op}	$\frac{\Delta f}{f}$	-7.0	+7.0	10^{-6}	From frequency measured at T_o °C
9	Resistance Variation with Temperature over T_{op}	ΔR	-2.0	+2.0	Ω	From resistance measured at T_o °C
10	Operating Temperature Range	T_{op}	-20	+55	°C	
11	Frequency variation with Drive Level	$\frac{\Delta f}{f}$	Not applicable		10^{-6}	
12	Resistance variation with Drive Level	$\frac{\Delta R}{R}$	Not applicable		%	
13	Motional Inductance	L_1	8.1	9.9	mH	
14	Motional Capacitance	C_1	Not applicable		fF	
15	Static Capacitance	C_o	-	4.0	pF	
16	Q Factor	Q	70 000	-	-	
17	Ratio of Unwanted: Response Resistance to Resonance Resistance or Response Impedance to Resonance Resistance	R_p/R or $ Z_p /R$	3:1	-		In the frequency range: $f_r - 200\text{kHz}$ to $f_r + 200\text{kHz}$
18	Ageing	$\frac{\Delta f}{f}$	-5.0	+5.0	10^{-6}	After burn-in, and over 3 years
19	Terminal Length	L	Figure 2		mm	



TABLE 1(a) - TYPE VARIANT DETAILED INFORMATION

TYPE VARIANT NO. 22

No.	Characteristics	Symbol	Limits		Unit	Remarks
			Min.	Max.		
1	Resonance Frequency	f_L	18.84		MHz	
2	Reference Temperature	T_0	+25		°C	
3	Overtone Order	-	Fundamental			
4	Load Capacitance	C_L	32		pF	
5	Rated Drive Level	P_0	0.1		mW	
6	Frequency Adjustment Tolerance	$\frac{\Delta f}{f}$	-5.0	+5.0	10^{-6}	At T_0 °C
7	Resonance Resistance	R_L	-	26	Ω	At T_0 °C
8	Frequency Variation with Temperature over T_{op}	$\frac{\Delta f}{f}$	-7.0	+7.0	10^{-6}	From frequency measured at T_0 °C
9	Resistance Variation with Temperature over T_{op}	ΔR	-2.0	+2.0	Ω	From resistance measured at T_0 °C
10	Operating Temperature Range	T_{op}	-20	+55	°C	
11	Frequency variation with Drive Level	$\frac{\Delta f}{f}$	Not applicable		10^{-6}	
12	Resistance variation with Drive Level	$\frac{\Delta R}{R}$	Not applicable		%	
13	Motional Inductance	L_1	13.68	16.72	mH	
14	Motional Capacitance	C_1	Not applicable		fF	
15	Static Capacitance	C_0	-	3.0	pF	
16	Q Factor	Q	80 000	-	-	
17	Ratio of Unwanted: Response Resistance to Resonance Resistance or Response Impedance to Resonance Resistance	R_p/R or $ Z_{pl}/R$	3:1	-		In the frequency range: $f_L - 500\text{kHz}$ to $f_L + 500\text{kHz}$
18	Ageing	$\frac{\Delta f}{f}$	-5.0	+5.0	10^{-6}	
19	Terminal Length	L	Figure 2		mm	

TABLE 1(a) - TYPE VARIANT DETAILED INFORMATION

TYPE VARIANT NO. 23

No.	Characteristics	Symbol	Limits		Unit	Remarks
			Min.	Max.		
1	Resonance Frequency	f_L	15.0		MHz	
2	Reference Temperature	T_o	+25		°C	
3	Overtone Order	-	Fundamental			
4	Load Capacitance	C_L	31	33	pF	
5	Rated Drive Level	P_o	0.1		mW	
6	Frequency Adjustment Tolerance	$\frac{\Delta f}{f}$	-10	+10	10^{-6}	At T_o °C
7	Resonance Resistance	R_L	-	20	Ω	At T_o °C
8	Frequency Variation with Temperature over T_{op}	$\frac{\Delta f}{f}$	-20	+20	10^{-6}	From frequency measured at T_o °C
9	Resistance Variation with Temperature over T_{op}	$\frac{\Delta R}{R}$	-10	+10	%	From resistance measured at T_o °C If $R < 10\Omega$
			-1.5	+1.5	Ω	
10	Operating Temperature Range	T_{op}	-30	+70	°C	
11	Frequency variation with Drive Level	$\frac{\Delta f}{f}$	Not applicable		10^{-6}	
12	Resistance variation with Drive Level	$\frac{\Delta R}{R}$	Not applicable		%	
13	Motional Inductance	L_1	8.8	12	mH	
14	Motional Capacitance	C_1	Not applicable		fF	
15	Static Capacitance	C_o	-	7.0	pF	
16	Q Factor	Q	80 000	-	-	
17	Ratio of Unwanted: Response Resistance to Resonance Resistance or Response Impedance to Resonance Resistance	R_p/R or $ Z_p /R$	Not applicable			
18	Ageing	$\frac{\Delta f}{f}$	-10	+10	10^{-6}	After burn-in, and per year
19	Terminal Length	L	Figure 2		mm	

TABLE 1(a) - TYPE VARIANT DETAILED INFORMATION

TYPE VARIANT NO. 24

No.	Characteristics	Symbol	Limits		Unit	Remarks
			Min.	Max.		
1	Resonance Frequency	f_L	20.0		MHz	
2	Reference Temperature	T_0	+59	+61	°C	
3	Overtone Order	-	Fundamental			
4	Load Capacitance	C_L	22		pF	
5	Rated Drive Level	P_0	0.1		mW	
6	Frequency Adjustment Tolerance	$\frac{\Delta f}{f}$	-10	+10	10^{-6}	At T_0 °C
7	Resonance Resistance	R_L	-	20	Ω	Over T_{op} °C
8	Frequency Variation with Temperature over T_{op}	$\frac{\Delta f}{f}$	-15	+15	10^{-6}	From frequency measured at T_0 °C
9	Resistance Variation with Temperature over T_{op}	$\frac{\Delta R}{R}$	Not applicable		%	
10	Operating Temperature Range	T_{op}	-20	+70	°C	
11	Frequency variation with Drive Level	$\frac{\Delta f}{f}$	Not applicable		10^{-6}	
12	Resistance variation with Drive Level	$\frac{\Delta R}{R}$	Not applicable		%	
13	Motional inductance	L_1	Not applicable		mH	
14	Motional Capacitance	C_1	Not applicable		fF	
15	Static Capacitance	C_0	-	4.5	pF	
16	Q Factor	Q	50 000	-	-	
17	Ratio of Unwanted: Response Resistance to Resonance Resistance or Response Impedance to Resonance Resistance	R_p/R or $ Z_p /R$	3:1	-		In the frequency range: $f_L - 200\text{kHz}$ to $f_L + 200\text{kHz}$
18	Ageing	$\frac{\Delta f}{f}$	-3.0	+3.0	10^{-6}	After burn-in, and per year
19	Terminal Length	L	Figure 2		mm	

TABLE 1(a) - TYPE VARIANT DETAILED INFORMATION

TYPE VARIANT NO. 25

No.	Characteristics	Symbol	Limits		Unit	Remarks
			Min.	Max.		
1	Resonance Frequency	f_r	36.693333		MHz	
2	Reference Temperature	T_0	+23	+27	°C	
3	Overtone Order	-	3			
4	Load Capacitance	C_L	∞		pF	
5	Rated Drive Level	P_0	0.1		mW	
6	Frequency Adjustment Tolerance	$\frac{\Delta f}{f}$	-10	+10	10^{-6}	At T_0 °C
7	Resonance Resistance	R_r	-	40	Ω	At T_0 °C
8	Frequency Variation with Temperature over T_{op}	$\frac{\Delta f}{f}$	-9.0	+9.0	10^{-6}	From frequency measured at T_0 °C
9	Resistance Variation with Temperature over T_{op}	$\frac{\Delta R}{R}$	-10	+10	%	From resistance measured at T_0 °C
10	Operating Temperature Range	T_{op}	-20	+70	°C	
11	Frequency variation with Drive Level	$\frac{\Delta f}{f}$	Not applicable		10^{-6}	
12	Resistance variation with Drive Level	$\frac{\Delta R}{R}$	Not applicable		%	
13	Motional Inductance	L_1	17.7	21.7	mH	
14	Motional Capacitance	C_1	Not applicable		fF	
15	Static Capacitance	C_0	-	7.0	pF	
16	Q Factor	Q	19 000	-	-	
17	Ratio of Unwanted: Response Resistance to Resonance Resistance or Response Impedance to Resonance Resistance	R_p/R or $ Z_p /R$	2:1	-		In the frequency range: $f_r - 50\text{kHz}$ to $f_r + 50\text{kHz}$
18	Ageing	$\frac{\Delta f}{f}$	-3.0	+3.0	10^{-6}	After burn-in, and per year
19	Terminal Length	L	Figure 2		mm	



TABLE 1(a) - TYPE VARIANT DETAILED INFORMATION

TYPE VARIANT NO. 26

No.	Characteristics	Symbol	Limits		Unit	Remarks
			Min.	Max.		
1	Resonance Frequency	f_L	20.8333		MHz	
2	Reference Temperature	T_0	+25		°C	
3	Overtone Order	-	Fundamental			
4	Load Capacitance	C_L	10		pF	
5	Rated Drive Level	P_0	0.1		mW	
6	Frequency Adjustment Tolerance	$\frac{\Delta f}{f}$	-10	+10	10^{-6}	At T_0 °C
7	Resonance Resistance	R_L	-	20	Ω	Over T_{op} °C
8	Frequency Variation with Temperature over T_{op}	$\frac{\Delta f}{f}$	-10	+10	10^{-6}	From frequency measured at T_0 °C
9	Resistance Variation with Temperature over T_{op}	$\frac{\Delta R}{R}$	Not applicable		%	
10	Operating Temperature Range	T_{op}	-10	+60	°C	
11	Frequency variation with Drive Level	$\frac{\Delta f}{f}$	Not applicable		10^{-6}	
12	Resistance variation with Drive Level	$\frac{\Delta R}{R}$	Not applicable		%	
13	Motional Inductance	L_1	Not applicable		mH	
14	Motional Capacitance	C_1	Not applicable		fF	
15	Static Capacitance	C_0	Not applicable		pF	
16	Q Factor	Q	Not applicable		-	
17	Ratio of Unwanted: Response Resistance to Resonance Resistance or Response Impedance to Resonance Resistance	R_p/R or $ Z_{pi}/R$	4:1	-		In the frequency range: $f_L -10\%$ to $f_L + 10\%$
18	Ageing	$\frac{\Delta f}{f}$	Not applicable		10^{-6}	
19	Terminal Length	L	Figure 2		mm	



TABLE 1(a) - TYPE VARIANT DETAILED INFORMATION

TYPE VARIANT NO. 27

No.	Characteristics	Symbol	Limits		Unit	Remarks
			Min.	Max.		
1	Resonance Frequency	f_L	22.841667		MHz	
2	Reference Temperature	T_0	+25		°C	
3	Overtone Order	-	Fundamental			
4	Load Capacitance	C_L	30		pF	
5	Rated Drive Level	P_0	0.1		mW	
6	Frequency Adjustment Tolerance	$\frac{\Delta f}{f}$	-10	+10	10^{-6}	At T_0 °C
7	Resonance Resistance	R_L	-	15	Ω	Over T_{op} °C
8	Frequency Variation with Temperature over T_{op}	$\frac{\Delta f}{f}$	-10	+10	10^{-6}	From frequency measured at T_0 °C
9	Resistance Variation with Temperature over T_{op}	$\frac{\Delta R}{R}$	Not applicable		%	
10	Operating Temperature Range	T_{op}	-25	+65	°C	
11	Frequency variation with Drive Level	$\frac{\Delta f}{f}$	Not applicable		10^{-6}	
12	Resistance variation with Drive Level	$\frac{\Delta R}{R}$	Not applicable		%	
13	Motional Inductance	L_1	Not applicable		mH	
14	Motional Capacitance	C_1	Not applicable		fF	
15	Static Capacitance	C_0	-	3.0	pF	
16	Q Factor	Q	Not applicable		-	
17	Ratio of Unwanted: Response Resistance to Resonance Resistance or Response Impedance to Resonance Resistance	R_p/R or $ Z_p /R$	3:1	-		In the frequency range: $f_L - 200\text{kHz}$ to $f_L + 200\text{kHz}$
18	Ageing	$\frac{\Delta f}{f}$	Not applicable		10^{-6}	
19	Terminal Length	L	Figure 2		mm	

TABLE 1(a) - TYPE VARIANT DETAILED INFORMATION

TYPE VARIANT NO. 28

No.	Characteristics	Symbol	Limits		Unit	Remarks
			Min.	Max.		
1	Resonance Frequency	f_L	22.856667		MHz	
2	Reference Temperature	T_0	+25		°C	
3	Overtone Order	-	Fundamental			
4	Load Capacitance	C_L	22	56	pF	
5	Rated Drive Level	P_0	0.1		mW	
6	Frequency Adjustment Tolerance	$\frac{\Delta f}{f}$	Not applicable		10^{-6}	
7	Resonance Resistance	R_L	-	40	Ω	Over T_{op} °C
8	Frequency Variation with Temperature over T_{op}	$\frac{\Delta f}{f}$	-7.0	+7.0	10^{-6}	From frequency measured at T_0 °C
9	Resistance Variation with Temperature over T_{op}	$\frac{\Delta R}{R}$	Not applicable		%	
10	Operating Temperature Range	T_{op}	-20	+50	°C	
11	Frequency variation with Drive Level	$\frac{\Delta f}{f}$	Not applicable		10^{-6}	
12	Resistance variation with Drive Level	$\frac{\Delta R}{R}$	Not applicable		%	
13	Motional Inductance	L_1	Not applicable		mH	
14	Motional Capacitance	C_1	Not applicable		fF	
15	Static Capacitance	C_0	Not applicable		pF	
16	Q Factor	Q	80 000	-	-	
17	Ratio of Unwanted: Response Resistance to Resonance Resistance or Response Impedance to Resonance Resistance	R_p/R or $ Z_{pl}/R$	3:1	-		In the frequency range: $f_L - 200\text{kHz}$ to $f_L + 200\text{kHz}$
18	Ageing	$\frac{\Delta f}{f}$	-10	+10	10^{-6}	After burn-in, over 8 years
19	Terminal Length	L	Figure 2		mm	



TABLE 1(a) - TYPE VARIANT DETAILED INFORMATION

TYPE VARIANT NO. 29

No.	Characteristics	Symbol	Limits		Unit	Remarks
			Min.	Max.		
1	Resonance Frequency	f_L	22.861667		MHz	
2	Reference Temperature	T_0	+25		°C	
3	Overtone Order	-	Fundamental			
4	Load Capacitance	C_L	30		pF	
5	Rated Drive Level	P_0	0.1		mW	
6	Frequency Adjustment Tolerance	$\frac{\Delta f}{f}$	-10	+10	10^{-6}	At T_0 °C
7	Resonance Resistance	R_L	-	15	Ω	Over T_{op} °C
8	Frequency Variation with Temperature over T_{op}	$\frac{\Delta f}{f}$	-10	+10	10^{-6}	From frequency measured at T_0 °C
9	Resistance Variation with Temperature over T_{op}	$\frac{\Delta R}{R}$	Not applicable		%	
10	Operating Temperature Range	T_{op}	-20	+65	°C	
11	Frequency variation with Drive Level	$\frac{\Delta f}{f}$	Not applicable		10^{-6}	
12	Resistance variation with Drive Level	$\frac{\Delta R}{R}$	Not applicable		%	
13	Motional Inductance	L_1	Not applicable		mH	
14	Motional Capacitance	C_1	Not applicable		fF	
15	Static Capacitance	C_0	-	4.0	pF	
16	Q Factor	Q	Not applicable		-	
17	Ratio of Unwanted: Response Resistance to Resonance Resistance or Response Impedance to Resonance Resistance	R_p/R or $ Z_p /R$	3:1	-		In the frequency range: $f_L - 200\text{kHz}$ to $f_L + 200\text{kHz}$
18	Ageing	$\frac{\Delta f}{f}$	Not applicable		10^{-6}	
19	Terminal Length	L	Figure 2		mm	



TABLE 1(a) - TYPE VARIANT DETAILED INFORMATION

TYPE VARIANT NO. 30

No.	Characteristics	Symbol	Limits		Unit	Remarks
			Min.	Max.		
1	Resonance Frequency	f_L	24.184		MHz	
2	Reference Temperature	T_0	+25		°C	
3	Overtone Order	-	Fundamental			
4	Load Capacitance	C_L	32		pF	
5	Rated Drive Level	P_0	0.1		mW	
6	Frequency Adjustment Tolerance	$\frac{\Delta f}{f}$	-5.0	+5.0	10^{-6}	At T_0 °C
7	Resonance Resistance	R_L	-	26	Ω	Over T_{op} °C
8	Frequency Variation with Temperature over T_{op}	$\frac{\Delta f}{f}$	-10	+10	10^{-6}	From frequency measured at T_0 °C
9	Resistance Variation with Temperature over T_{op}	$\frac{\Delta R}{R}$	Not applicable		%	
10	Operating Temperature Range	T_{op}	-10	+50	°C	
11	Frequency variation with Drive Level	$\frac{\Delta f}{f}$	Not applicable		10^{-6}	
12	Resistance variation with Drive Level	$\frac{\Delta R}{R}$	Not applicable		%	
13	Motional Inductance	L_1	Not applicable		mH	
14	Motional Capacitance	C_1	Not applicable		fF	
15	Static Capacitance	C_0	-	3.5	pF	
16	Q Factor	Q	50 000	-	-	
17	Ratio of Unwanted: Response Resistance to Resonance Resistance or Response Impedance to Resonance Resistance	R_p/R or $ Z_p /R$	10:1	-		In the frequency range: $f_L - 2.0\text{MHz}$ to $f_L + 2.0\text{MHz}$
18	Ageing	$\frac{\Delta f}{f}$	-5.0	+5.0	10^{-6}	After burn-in, and per year
19	Terminal Length	L	Figure 2		mm	



TABLE 1(a) - TYPE VARIANT DETAILED INFORMATION

TYPE VARIANT NO. 31

No.	Characteristics	Symbol	Limits		Unit	Remarks
			Min.	Max.		
1	Resonance Frequency	f_L	24.5		MHz	
2	Reference Temperature	T_0	+25		°C	
3	Overtone Order	-	Fundamental			
4	Load Capacitance	C_L	30		pF	
5	Rated Drive Level	P_0	0.1		mW	
6	Frequency Adjustment Tolerance	$\frac{\Delta f}{f}$	-5.0	+5.0	10^{-6}	At T_0 °C
7	Resonance Resistance	R_L	-	25	Ω	Over T_{op} °C
8	Frequency Variation with Temperature over T_{op}	$\frac{\Delta f}{f}$	-7.0	+7.0	10^{-6}	From frequency measured at T_0 °C
9	Resistance Variation with Temperature over T_{op}	$\frac{\Delta R}{R}$	Not applicable		%	
10	Operating Temperature Range	T_{op}	-20	+60	°C	
11	Frequency variation with Drive Level	$\frac{\Delta f}{f}$	Not applicable		10^{-6}	
12	Resistance variation with Drive Level	$\frac{\Delta R}{R}$	Not applicable		%	
13	Motional Inductance	L_1	Not applicable		mH	
14	Motional Capacitance	C_1	Not applicable		fF	
15	Static Capacitance	C_0	-	5.0	pF	
16	Q Factor	Q	80 000	-	-	
17	Ratio of Unwanted: Response Resistance to Resonance Resistance or Response Impedance to Resonance Resistance	R_p/R $ Z_p /R$	3:1	-		In the frequency range: $f_L - 200\text{kHz}$ to $f_L + 200\text{kHz}$
18	Ageing	$\frac{\Delta f}{f}$	-5.0	+5.0	10^{-6}	After burn-in, and per year
19	Terminal Length	L	Figure 2		mm	

TABLE 1(a) - TYPE VARIANT DETAILED INFORMATION

TYPE VARIANT NO. 32

No.	Characteristics	Symbol	Limits		Unit	Remarks
			Min.	Max.		
1	Resonance Frequency	f_L	24.5		MHz	
2	Reference Temperature	T_0	+25		°C	
3	Overtone Order	-	Fundamental			
4	Load Capacitance	C_L	32		pF	
5	Rated Drive Level	P_0	0.1		mW	
6	Frequency Adjustment Tolerance	$\frac{\Delta f}{f}$	-5.0	+5.0	10^{-6}	At T_0 °C
7	Resonance Resistance	R_L	-	21	Ω	At T_0 °C
8	Frequency Variation with Temperature over T_{op}	$\frac{\Delta f}{f}$	-7.0	+7.0	10^{-6}	From frequency measured at T_0 °C
9	Resistance Variation with Temperature over T_{op}	ΔR	-2.0	+2.0	Ω	From resistance measured at T_0 °C
10	Operating Temperature Range	T_{op}	-20	+55	°C	
11	Frequency variation with Drive Level	$\frac{\Delta f}{f}$	Not applicable		10^{-6}	
12	Resistance variation with Drive Level	$\frac{\Delta R}{R}$	Not applicable		%	
13	Motional Inductance	L_1	6.23	7.62	mH	
14	Motional Capacitance	C_1	Not applicable		fF	
15	Static Capacitance	C_0	-	3.0	pF	
16	Q Factor	Q	80 000	-	-	
17	Ratio of Unwanted: Response Resistance to Resonance Resistance or Response Impedance to Resonance Resistance	R_p/R $ Z_p /R$	3:1	-		In the frequency range: $f_L - 500\text{kHz}$ to $f_L + 500\text{kHz}$
18	Ageing	$\frac{\Delta f}{f}$	-5.0	+5.0	10^{-6}	After burn-in, and over 3 years
19	Terminal Length	L	Figure 2		mm	



TABLE 1(a) - TYPE VARIANT DETAILED INFORMATION

TYPE VARIANT NO. 33

No.	Characteristics	Symbol	Limits		Unit	Remarks
			Min.	Max.		
1	Resonance Frequency	f_r	36.666 -38.333		MHz	
2	Reference Temperature	T_0	+25		°C	
3	Overtone Order	-	3			
4	Load Capacitance	C_L	∞		pF	
5	Rated Drive Level	P_0	0.1		mW	
6	Frequency Adjustment Tolerance	$\frac{\Delta f}{f}$	-5.0	+5.0	10^{-6}	At T_0 °C
7	Resonance Resistance	R_r	-	40	Ω	Over T_{op} °C
8	Frequency Variation with Temperature over T_{op}	$\frac{\Delta f}{f}$	-7.0	+7.0	10^{-6}	From frequency measured at T_0 °C
9	Resistance Variation with Temperature over T_{op}	$\frac{\Delta R}{R}$	Not applicable		%	
10	Operating Temperature Range	T_{op}	-20	+60	°C	
11	Frequency variation with Drive Level	$\frac{\Delta f}{f}$	Not applicable		10^{-6}	
12	Resistance variation with Drive Level	$\frac{\Delta R}{R}$	Not applicable		%	
13	Motional Inductance	L_1	Not applicable		mH	
14	Motional Capacitance	C_1	Not applicable		fF	
15	Static Capacitance	C_0	-	5.0	pF	
16	Q Factor	Q	Not applicable		-	
17	Ratio of Unwanted: Response Resistance to Resonance Resistance or Response Impedance to Resonance Resistance	R_p/R or iZ_p/R	3:1	-		In the frequency range: $f_r - 50\text{kHz}$ to $f_r + 50\text{kHz}$
18	Ageing	$\frac{\Delta f}{f}$	-3.0	+3.0	10^{-6}	After burn-in, and per year
19	Terminal Length	L	Figure 2		mm	



TABLE 1(a) - TYPE VARIANT DETAILED INFORMATION

TYPE VARIANT NO. 34

No.	Characteristics	Symbol	Limits		Unit	Remarks
			Min.	Max.		
1	Resonance Frequency	f_L	38.25618		MHz	
2	Reference Temperature	T_o	+22		°C	
3	Overtone Order	-	3			
4	Load Capacitance	C_L	10	100	pF	
5	Rated Drive Level	P_o	0.1		mW	
6	Frequency Adjustment Tolerance	$\frac{\Delta f}{f}$	-8.0	+8.0	10^{-6}	At T_o °C
7	Resonance Resistance	R_L	-	75	Ω	Over T_{op} °C
8	Frequency Variation with Temperature over T_{op}	$\frac{\Delta f}{f}$	-4.0	+4.0	10^{-6}	From frequency measured at T_o °C
9	Resistance Variation with Temperature over T_{op}	$\frac{\Delta R}{R}$	Not applicable		%	
10	Operating Temperature Range	T_{op}	0	+40	°C	
11	Frequency variation with Drive Level	$\frac{\Delta f}{f}$	Not applicable		10^{-6}	
12	Resistance variation with Drive Level	$\frac{\Delta R}{R}$	Not applicable		%	
13	Motional Inductance	L_1	Not applicable		mH	
14	Motional Capacitance	C_1	Not applicable		fF	
15	Static Capacitance	C_o	-	2.0	pF	
16	Q Factor	Q	200 000	-	-	
17	Ratio of Unwanted: Response Resistance to Resonance Resistance or Response Impedance to Resonance Resistance	R_p/R or $ Z_{pl}/R$	3:1	-		In the frequency range: $f_L - 1.0\text{MHz}$ to $f_L + 1.0\text{MHz}$
18	Ageing	$\frac{\Delta f}{f}$	-2.0	+2.0	10^{-6}	Per year
19	Terminal Length	L	Figure 2		mm	



TABLE 1(a) - TYPE VARIANT DETAILED INFORMATION

TYPE VARIANT NO. 35

No.	Characteristics	Symbol	Limits		Unit	Remarks
			Min.	Max.		
1	Resonance Frequency	f_L	55.46875		MHz	
2	Reference Temperature	T_0	+45		°C	
3	Overtone Order	-	3			
4	Load Capacitance	C_L	20		pF	
5	Rated Drive Level	P_0	0.1		mW	
6	Frequency Adjustment Tolerance	$\frac{\Delta f}{f}$	-5.0	+5.0	10^{-6}	At T_0 °C
7	Resonance Resistance	R_L	-	40	Ω	Over T_{op} °C
8	Frequency Variation with Temperature over T_{op}	$\frac{\Delta f}{f}$	-0.4	+0.4	10^{-6}	From frequency measured at T_0 °C
9	Resistance Variation with Temperature over T_{op}	$\frac{\Delta R}{R}$	Not applicable		%	
10	Operating Temperature Range	T_{op}	-43	+47	°C	
11	Frequency variation with Drive Level	$\frac{\Delta f}{f}$	Not applicable		10^{-6}	
12	Resistance variation with Drive Level	$\frac{\Delta R}{R}$	Not applicable		%	
13	Motional Inductance	L_1	Not applicable		mH	
14	Motional Capacitance	C_1	Not applicable		fF	
15	Static Capacitance	C_0	2.5	3.5	pF	
16	Q Factor	Q	100 000	-	-	
17	Ratio of Unwanted: Response Resistance to Resonance Resistance or Response Impedance to Resonance Resistance	R_p/R $ Z_p /R$	10:1	-		In the frequency range: $f_L - 50\text{kHz}$ to $f_L + 50\text{kHz}$
18	Ageing	$\frac{\Delta f}{f}$	-1.5	+1.5	10^{-6}	Per year after burn-in
19	Terminal Length	L	Figure 2		mm	



TABLE 1(a) - TYPE VARIANT DETAILED INFORMATION

TYPE VARIANT NO. 36

No.	Characteristics	Symbol	Limits		Unit	Remarks
			Min.	Max.		
1	Resonance Frequency	f_L	62.5 -68.125		MHz	
2	Reference Temperature	T_0	+25		°C	
3	Overtone Order	-	3			
4	Load Capacitance	C_L	10		pF	
5	Rated Drive Level	P_0	0.1		mW	
6	Frequency Adjustment Tolerance	$\frac{\Delta f}{f}$	-10	+10	10^{-6}	At T_0 °C
7	Resonance Resistance	R_L	-	40	Ω	Over T_{op} °C
8	Frequency Variation with Temperature over T_{op}	$\frac{\Delta f}{f}$	-10	+10	10^{-6}	From frequency measured at T_0 °C
9	Resistance Variation with Temperature over T_{op}	$\frac{\Delta R}{R}$	Not applicable		%	
10	Operating Temperature Range	T_{op}	-10	+60	°C	
11	Frequency variation with Drive Level	$\frac{\Delta f}{f}$	Not applicable		10^{-6}	
12	Resistance variation with Drive Level	$\frac{\Delta R}{R}$	Not applicable		%	
13	Motional Inductance	L_1	Not applicable		mH	
14	Motional Capacitance	C_1	Not applicable		fF	
15	Static Capacitance	C_0	Not applicable		pF	
16	Q Factor	Q	Not applicable		-	
17	Ratio of Unwanted: Response Resistance to Resonance Resistance or Response Impedance to Resonance Resistance	R_p/R or $ Z_p /R$	4:1	-		In the frequency range: $f_L -10\%$ to $f_L +10\%$
18	Ageing	$\frac{\Delta f}{f}$	Not applicable		10^{-6}	
19	Terminal Length	L	Figure 2		mm	



TABLE 1(a) - TYPE VARIANT DETAILED INFORMATION

TYPE VARIANT NO. 37

No.	Characteristics	Symbol	Limits		Unit	Remarks
			Min.	Max.		
1	Resonance Frequency	f_L	71.859475		MHz	
2	Reference Temperature	T_o	+25		°C	
3	Overtone Order	-	5			
4	Load Capacitance	C_L	15	100	pF	
5	Rated Drive Level	P_o	0.1		mW	
6	Frequency Adjustment Tolerance	$\frac{\Delta f}{f}$	-2.0	+2.0	10^{-6}	At T_o °C
7	Resonance Resistance	R_L	70	130	Ω	Over T_{op} °C
8	Frequency Variation with Temperature over T_{op}	$\frac{\Delta f}{f}$	-7.0	+7.0	10^{-6}	From frequency measured at T_o °C
9	Resistance Variation with Temperature over T_{op}	$\frac{\Delta R}{R}$	Not applicable		%	
10	Operating Temperature Range	T_{op}	-20	+50	°C	
11	Frequency variation with Drive Level	$\frac{\Delta f}{f}$	Not applicable		10^{-6}	
12	Resistance variation with Drive Level	$\frac{\Delta R}{R}$	Not applicable		%	
13	Motional Inductance	L_1	Not applicable		mH	
14	Motional Capacitance	C_1	Not applicable		fF	
15	Static Capacitance	C_o	-	2.0	pF	
16	Q Factor	Q	100 000	-	-	
17	Ratio of Unwanted: Response Resistance to Resonance Resistance or Response Impedance to Resonance Resistance	R_p/R or $ Z_p /R$	3:1	-		In the frequency range: $f_L - 50\text{kHz}$ to $f_L + 50\text{kHz}$
18	Ageing	$\frac{\Delta f}{f}$	-2.0	+2.0	10^{-6}	After burn-in, and per year
19	Terminal Length	L	Figure 2		mm	



TABLE 1(a) - TYPE VARIANT DETAILED INFORMATION

TYPE VARIANT NO. 38

No.	Characteristics	Symbol	Limits		Unit	Remarks
			Min.	Max.		
1	Resonance Frequency	f_L	75.36015		MHz	
2	Reference Temperature	T_0	+25		°C	
3	Overtone Order	-	5			
4	Load Capacitance	C_L	15	100	pF	
5	Rated Drive Level	P_0	0.1		mW	
6	Frequency Adjustment Tolerance	$\frac{\Delta f}{f}$	-2.0	+2.0	10^{-6}	At T_0 °C
7	Resonance Resistance	R_L	70	130	Ω	Over T_{op} °C
8	Frequency Variation with Temperature over T_{op}	$\frac{\Delta f}{f}$	-7.0	+7.0	10^{-6}	From frequency measured at T_0 °C
9	Resistance Variation with Temperature over T_{op}	$\frac{\Delta R}{R}$	Not applicable		%	
10	Operating Temperature Range	T_{op}	-20	+50	°C	
11	Frequency variation with Drive Level	$\frac{\Delta f}{f}$	Not applicable		10^{-6}	
12	Resistance variation with Drive Level	$\frac{\Delta R}{R}$	Not applicable		%	
13	Motional Inductance	L_1	Not applicable		mH	
14	Motional Capacitance	C_1	Not applicable		fF	
15	Static Capacitance	C_0	-	2.0	pF	
16	Q Factor	Q	100 000	-	-	
17	Ratio of Unwanted: Response Resistance to Resonance Resistance or Response Impedance to Resonance Resistance	R_p/R or $ Z_p /R$	3:1	-		In the frequency range: $f_L - 50\text{kHz}$ to $f_L + 50\text{kHz}$
18	Ageing	$\frac{\Delta f}{f}$	-2.0	+2.0	10^{-6}	After burn-in, and per year
19	Terminal Length	L	Figure 2		mm	

TABLE 1(a) - TYPE VARIANT DETAILED INFORMATION

TYPE VARIANT NO. 39

No.	Characteristics	Symbol	Limits		Unit	Remarks
			Min.	Max.		
1	Resonance Frequency	f_L	79.516319		MHz	
2	Reference Temperature	T_o	+30		°C	
3	Overtone Order	-	3			
4	Load Capacitance	C_L	20	33	pF	
5	Rated Drive Level	P_o	0.1		mW	
6	Frequency Adjustment Tolerance	$\frac{\Delta f}{f}$	Not applicable		10^{-6}	
7	Resonance Resistance	R_L	-	50	Ω	Over T_{cp} °C
8	Frequency Variation with Temperature over T_{op}	$\frac{\Delta f}{f}$	-10	+10	10^{-6}	From frequency measured at T_o °C
9	Resistance Variation with Temperature over T_{op}	$\frac{\Delta R}{R}$	Not applicable		%	
10	Operating Temperature Range	T_{op}	-10	+70	°C	
11	Frequency variation with Drive Level	$\frac{\Delta f}{f}$	Not applicable		10^{-6}	
12	Resistance variation with Drive Level	$\frac{\Delta R}{R}$	Not applicable		%	
13	Motional Inductance	L_1	Not applicable		mH	
14	Motional Capacitance	C_1	Not applicable		fF	
15	Static Capacitance	C_o	-	4.0	pF	
16	Q Factor	Q	Not applicable		-	
17	Ratio of Unwanted: Response Resistance to Resonance Resistance or Response Impedance to Resonance Resistance	R_p/R or $ Z_p /R$	3:1	-		In the frequency range: $f_L - 50\text{kHz}$ to $f_L + 50\text{kHz}$
18	Ageing	$\frac{\Delta f}{f}$	-5.0	+5.0	10^{-6}	After burn-in, over 3 years
19	Terminal Length	L	Figure 2		mm	

TABLE 1(a) - TYPE VARIANT DETAILED INFORMATION

TYPE VARIANT NO. 40

No.	Characteristics	Symbol	Limits		Unit	Remarks
			Min.	Max.		
1	Resonance Frequency	f_L	80.381944		MHz	
2	Reference Temperature	T_0	+25		°C	
3	Overtone Order	-	3			
4	Load Capacitance	C_L	21.6	31.4	pF	
5	Rated Drive Level	P_0	0.1		mW	
6	Frequency Adjustment Tolerance	$\frac{\Delta f}{f}$	Not applicable		10^{-6}	
7	Resonance Resistance	R_L	-	50	Ω	Over T_{op} °C
8	Frequency Variation with Temperature over T_{op}	$\frac{\Delta f}{f}$	-10	+10	10^{-6}	From frequency measured at T_0 °C
9	Resistance Variation with Temperature over T_{op}	$\frac{\Delta R}{R}$	Not applicable		%	
10	Operating Temperature Range	T_{op}	-25	+65	°C	
11	Frequency variation with Drive Level	$\frac{\Delta f}{f}$	Not applicable		10^{-6}	
12	Resistance variation with Drive Level	$\frac{\Delta R}{R}$	Not applicable		%	
13	Motional Inductance	L_1	Not applicable		mH	
14	Motional Capacitance	C_1	Not applicable		fF	
15	Static Capacitance	C_0	-3.6	4.4	pF	
16	Q Factor	Q	Not applicable		-	
17	Ratio of Unwanted: Response Resistance to Resonance Resistance or Response Impedance to Resonance Resistance	R_p/R or $ Z_p /R$	2:1	-		In the frequency range: f_L -50kHz to f_L + 50kHz
18	Ageing	$\frac{\Delta f}{f}$	Not applicable		10^{-6}	
19	Terminal Length	L	Figure 2		mm	



TABLE 1(a) - TYPE VARIANT DETAILED INFORMATION

TYPE VARIANT NO. 41

No.	Characteristics	Symbol	Limits		Unit	Remarks
			Min.	Max.		
1	Resonance Frequency	f_L	81.847222		MHz	
2	Reference Temperature	T_0	+25		°C	
3	Overtone Order	-	3			
4	Load Capacitance	C_L	20	33	pF	
5	Rated Drive Level	P_0	0.1		mW	
6	Frequency Adjustment Tolerance	$\frac{\Delta f}{f}$	Not applicable		10^{-6}	
7	Resonance Resistance	R_L	Not applicable		Ω	
8	Frequency Variation with Temperature over T_{op}	$\frac{\Delta f}{f}$	-10	+10	10^{-6}	From frequency measured at T_0 °C
9	Resistance Variation with Temperature over T_{op}	$\frac{\Delta R}{R}$	Not applicable		%	
10	Operating Temperature Range	T_{op}	-25	+65	°C	
11	Frequency variation with Drive Level	$\frac{\Delta f}{f}$	Not applicable		10^{-6}	
12	Resistance variation with Drive Level	$\frac{\Delta R}{R}$	Not applicable		%	
13	Motional Inductance	L_1	Not applicable		mH	
14	Motional Capacitance	C_1	Not applicable		fF	
15	Static Capacitance	C_0	Not applicable		pF	
16	Q Factor	Q	Not applicable		-	
17	Ratio of Unwanted: Response Resistance to Resonance Resistance or Response Impedance to Resonance Resistance	R_p/R or $ Z_p /R$	Not applicable			
18	Ageing	$\frac{\Delta f}{f}$	Not applicable		10^{-6}	
19	Terminal Length	L	Figure 2		mm	



TABLE 1(a) - TYPE VARIANT DETAILED INFORMATION

TYPE VARIANT NO. 42

No.	Characteristics	Symbol	Limits		Unit	Remarks
			Min.	Max.		
1	Resonance Frequency	f_r	99.1		MHz	
2	Reference Temperature	T_o	+25		°C	
3	Overtone Order	-	5			
4	Load Capacitance	C_L	∞		pF	
5	Rated Drive Level	P_o	0.1		mW	
6	Frequency Adjustment Tolerance	$\frac{\Delta f}{f}$	-5.0	+5.0	10^{-6}	At T_o °C
7	Resonance Resistance	R_r	-	50	Ω	At T_o °C
8	Frequency Variation with Temperature over T_{op}	$\frac{\Delta f}{f}$	-5.0	+5.0	10^{-6}	From frequency measured at T_o °C
9	Resistance Variation with Temperature over T_{op}	$\frac{\Delta R}{R}$	-10	+10	%	From resistance measured at T_o °C
10	Operating Temperature Range	T_{op}	-20	+60	°C	
11	Frequency variation with Drive Level	$\frac{\Delta f}{f}$	Not applicable		10^{-6}	
12	Resistance variation with Drive Level	$\frac{\Delta R}{R}$	Not applicable		%	
13	Motional Inductance	L_1	Not applicable		mH	
14	Motional Capacitance	C_1	Not applicable		fF	
15	Static Capacitance	C_o	-	3.5	pF	
16	Q Factor	Q	Not applicable		-	
17	Ratio of Unwanted: Response Resistance to Resonance Resistance or Response Impedance to Resonance Resistance	R_p/R or iZ_p/R	3:1	-		In the frequency range: $f_r -20\%$ to $f_r +20\%$
18	Ageing	$\frac{\Delta f}{f}$	-3.0	+3.0	10^{-6}	After burn-in, over 3 years
19	Terminal Length	L	Figure 2		mm	



TABLE 1(a) - TYPE VARIANT DETAILED INFORMATION

TYPE VARIANT NO. 43

No.	Characteristics	Symbol	Limits		Unit	Remarks
			Min.	Max.		
1	Resonance Frequency	f_L	105.0		MHz	
2	Reference Temperature	T_0	+25		°C	
3	Overtone Order	-	5			
4	Load Capacitance	C_L	10		pF	
5	Rated Drive Level	P_0	0.1		mW	
6	Frequency Adjustment Tolerance	$\frac{\Delta f}{f}$	-10	+10	10^{-6}	At T_0 °C
7	Resonance Resistance	R_L	-	60	Ω	Over T_{op} °C
8	Frequency Variation with Temperature over T_{op}	$\frac{\Delta f}{f}$	-10	+10	10^{-6}	From frequency measured at T_0 °C
9	Resistance Variation with Temperature over T_{op}	$\frac{\Delta R}{R}$	Not applicable		%	
10	Operating Temperature Range	T_{op}	-10	+60	°C	
11	Frequency variation with Drive Level	$\frac{\Delta f}{f}$	Not applicable		10^{-6}	
12	Resistance variation with Drive Level	$\frac{\Delta R}{R}$	Not applicable		%	
13	Motional Inductance	L_1	Not applicable		mH	
14	Motional Capacitance	C_1	Not applicable		fF	
15	Static Capacitance	C_0	Not applicable		pF	
16	Q Factor	Q	Not applicable		-	
17	Ratio of Unwanted: Response Resistance to Resonance Resistance or Response Impedance to Resonance Resistance	R_p/R or $ Z_p /R$	3:1	-		In the frequency range: $f_L - 10\%$ to $f_L + 10\%$
18	Ageing	$\frac{\Delta f}{f}$	Not applicable		10^{-6}	
19	Terminal Length	L	Figure 2		mm	



TABLE 1(a) - TYPE VARIANT DETAILED INFORMATION

TYPE VARIANT NO. 44

No.	Characteristics	Symbol	Limits		Unit	Remarks
			Min.	Max.		
1	Resonance Frequency	f_r	120.796		MHz	
2	Reference Temperature	T_0	+25		°C	
3	Overtone Order	-	5			
4	Load Capacitance	C_L	∞		pF	
5	Rated Drive Level	P_0	0.1		mW	
6	Frequency Adjustment Tolerance	$\frac{\Delta f}{f}$	-5.0	+5.0	10^{-6}	At T_0 °C
7	Resonance Resistance	R_r	-	55	Ω	Over T_{op} °C
8	Frequency Variation with Temperature over T_{op}	$\frac{\Delta f}{f}$	-10	+10	10^{-6}	From frequency measured at T_0 °C
9	Resistance Variation with Temperature over T_{op}	$\frac{\Delta R}{R}$	Not applicable		%	
10	Operating Temperature Range	T_{op}	-10	+50	°C	
11	Frequency variation with Drive Level	$\frac{\Delta f}{f}$	Not applicable		10^{-6}	
12	Resistance variation with Drive Level	$\frac{\Delta R}{R}$	Not applicable		%	
13	Motional Inductance	L_1	Not applicable		mH	
14	Motional Capacitance	C_1	Not applicable		fF	
15	Static Capacitance	C_0	-	3.5	pF	
16	Q Factor	Q	70 000	-	-	
17	Ratio of Unwanted: Response Resistance to Resonance Resistance or Response Impedance to Resonance Resistance	R_p/R or $ Z_p /R$	Not applicable			
18	Ageing	$\frac{\Delta f}{f}$	-5.0	+5.0	10^{-6}	After burn-in, per year
19	Terminal Length	L	Figure 2		mm	



TABLE 1(a) - TYPE VARIANT DETAILED INFORMATION

TYPE VARIANT NO. 45

No.	Characteristics	Symbol	Limits		Unit	Remarks
			Min.	Max.		
1	Resonance Frequency	f_r	61.805555		MHz	$f_s = 61.8047\text{MHz}$
2	Reference Temperature	T_o	+23	+27	°C	
3	Overtone Order	-	3			
4	Load Capacitance	C_L	∞		pF	
5	Rated Drive Level	P_o	0.1		mW	
6	Frequency Adjustment Tolerance	$\frac{\Delta f}{f}$	-5.0	+5.0	10^{-6}	At T_o °C
7	Resonance Resistance	R_r	-	40	Ω	At T_o °C
8	Frequency Variation with Temperature over T_{op}	$\frac{\Delta f}{f}$	-10	+10	10^{-6}	From frequency measured at T_o °C
9	Resistance Variation with Temperature over T_{op}	$\frac{\Delta R}{R}$	-20	+20	%	From resistance measured at T_o °C
10	Operating Temperature Range	T_{op}	-20	+70	°C	
11	Frequency variation with Drive Level	$\frac{\Delta f}{f}$	Not applicable		10^{-6}	
12	Resistance variation with Drive Level	$\frac{\Delta R}{R}$	Not applicable		%	
13	Motional Inductance	L_1	Not applicable		mH	
14	Motional Capacitance	C_1	Not applicable		fF	
15	Static Capacitance	C_o	-	7.0	pF	
16	Q Factor	Q	Not applicable		-	
17	Ratio of Unwanted: Response Resistance to Resonance Resistance or Response Impedance to Resonance Resistance	R_p/R or iZ_p/R	2:1	-		In the frequency range: $f_r - 60\text{kHz}$ to $f_r + 60\text{kHz}$
18	Ageing	$\frac{\Delta f}{f}$	-3.0	+3.0	10^{-6}	
19	Terminal Length	L	Figure 2		mm	

TABLE 1(a) - TYPE VARIANT DETAILED INFORMATION

TYPE VARIANT NO. 46

No.	Characteristics	Symbol	Limits		Unit	Remarks
			Min.	Max.		
1	Resonance Frequency	f_r	62.5		MHz	$f_s = 62.4992\text{MHz}$
2	Reference Temperature	T_0	+23	+27	°C	
3	Overtone Order	-	3			
4	Load Capacitance	C_L	∞		pF	
5	Rated Drive Level	P_0	0.1		mW	
6	Frequency Adjustment Tolerance	$\frac{\Delta f}{f}$	-5.0	+5.0	10^{-6}	At T_0 °C
7	Resonance Resistance	R_r	-	40	Ω	At T_0 °C
8	Frequency Variation with Temperature over T_{op}	$\frac{\Delta f}{f}$	-10	+10	10^{-6}	From frequency measured at T_0 °C
9	Resistance Variation with Temperature over T_{op}	$\frac{\Delta R}{R}$	-20	+20	%	From resistance measured at T_0 °C
10	Operating Temperature Range	T_{op}	-20	+70	°C	
11	Frequency variation with Drive Level	$\frac{\Delta f}{f}$	Not applicable		10^{-6}	
12	Resistance variation with Drive Level	$\frac{\Delta R}{R}$	Not applicable		%	
13	Motional Inductance	L_1	Not applicable		mH	
14	Motional Capacitance	C_1	Not applicable		fF	
15	Static Capacitance	C_0	-	7.0	pF	
16	Q Factor	Q	Not applicable		-	
17	Ratio of Unwanted: Response Resistance to Resonance Resistance or Response Impedance to Resonance Resistance	R_p/R or $ Z_p /R$	2:1	-		In the frequency range: $f_r - 60\text{kHz}$ to $f_r + 60\text{kHz}$
18	Ageing	$\frac{\Delta f}{f}$	-3.0	+3.0	10^{-6}	After burn-in, and per year
19	Terminal Length	L	Figure 2		mm	



TABLE 1(a) - TYPE VARIANT DETAILED INFORMATION

TYPE VARIANT NO. 47

No.	Characteristics	Symbol	Limits		Unit	Remarks
			Min.	Max.		
1	Resonance Frequency	f_r	62.03125		MHz	$f_s = 62.03045\text{MHz}$
2	Reference Temperature	T_0	+23	+27	°C	
3	Overtone Order	-	3			
4	Load Capacitance	C_L	∞		pF	
5	Rated Drive Level	P_0	0.1		mW	
6	Frequency Adjustment Tolerance	$\frac{\Delta f}{f}$	-5.0	+5.0	10^{-6}	At T_0 °C
7	Resonance Resistance	R_r	-	40	Ω	At T_0 °C
8	Frequency Variation with Temperature over T_{op}	$\frac{\Delta f}{f}$	-10	+10	10^{-6}	From frequency measured at T_0 °C
9	Resistance Variation with Temperature over T_{op}	$\frac{\Delta R}{R}$	-20	+20	%	From resistance measured at T_0 °C
10	Operating Temperature Range	T_{op}	-20	+70	°C	
11	Frequency variation with Drive Level	$\frac{\Delta f}{f}$	Not applicable		10^{-6}	
12	Resistance variation with Drive Level	$\frac{\Delta R}{R}$	Not applicable		%	
13	Motional Inductance	L_1	Not applicable		mH	
14	Motional Capacitance	C_1	Not applicable		fF	
15	Static Capacitance	C_0	-	7.0	pF	
16	Q Factor	Q	Not applicable		-	
17	Ratio of Unwanted: Response Resistance to Resonance Resistance or Response Impedance to Resonance Resistance	R_p/R or $ Z_{pi} /R$	2:1	-		In the frequency range: $f_r - 60\text{kHz}$ to $f_r + 60\text{kHz}$
18	Ageing	$\frac{\Delta f}{f}$	-3.0	+3.0	10^{-6}	After burn-in, and per year
19	Terminal Length	L	Figure 2		mm	



TABLE 1(a) - TYPE VARIANT DETAILED INFORMATION

TYPE VARIANT NO. 48

No.	Characteristics	Symbol	Limits		Unit	Remarks
			Min.	Max.		
1	Resonance Frequency	f_r	62.109375		MHz	$f_s = 62.108575\text{MHz}$
2	Reference Temperature	T_0	+23	+27	°C	
3	Overtone Order	-	3			
4	Load Capacitance	C_L	∞		pF	
5	Rated Drive Level	P_0	0.1		mW	
6	Frequency Adjustment Tolerance	$\frac{\Delta f}{f}$	-5.0	+5.0	10^{-6}	At T_0 °C
7	Resonance Resistance	R_r	-	40	Ω	At T_0 °C
8	Frequency Variation with Temperature over T_{op}	$\frac{\Delta f}{f}$	-10	+10	10^{-6}	From frequency measured at T_0 °C
9	Resistance Variation with Temperature over T_{op}	$\frac{\Delta R}{R}$	-20	+20	%	From resistance measured at T_0 °C
10	Operating Temperature Range	T_{op}	-20	+70	°C	
11	Frequency variation with Drive Level	$\frac{\Delta f}{f}$	Not applicable		10^{-6}	
12	Resistance variation with Drive Level	$\frac{\Delta R}{R}$	Not applicable		%	
13	Motional Inductance	L_1	Not applicable		mH	
14	Motional Capacitance	C_1	Not applicable		fF	
15	Static Capacitance	C_0	-	7.0	pF	
16	Q Factor	Q	Not applicable		-	
17	Ratio of Unwanted: Response Resistance to Resonance Resistance or Response Impedance to Resonance Resistance	R_p/R $ Z_{pl}/R$	2:1	-		In the frequency range: $f_r - 60\text{kHz}$ to $f_r + 60\text{kHz}$
18	Ageing	$\frac{\Delta f}{f}$	-3.0	+3.0	10^{-6}	After burn-in, and per year
19	Terminal Length	L	Figure 2		mm	



TABLE 1(a) - TYPE VARIANT DETAILED INFORMATION

TYPE VARIANT NO. 49

No.	Characteristics	Symbol	Limits		Unit	Remarks
			Min.	Max.		
1	Resonance Frequency	f_r	69.559524		MHz	$f_s = 69.5587\text{MHz}$
2	Reference Temperature	T_0	+23	+27	°C	
3	Overtone Order	-	3			
4	Load Capacitance	C_L	∞		pF	
5	Rated Drive Level	P_0	0.1		mW	
6	Frequency Adjustment Tolerance	$\frac{\Delta f}{f}$	-5.0	+5.0	10^{-6}	At T_0 °C
7	Resonance Resistance	R_r	-	40	Ω	At T_0 °C
8	Frequency Variation with Temperature over T_{op}	$\frac{\Delta f}{f}$	-10	+10	10^{-6}	From frequency measured at T_0 °C
9	Resistance Variation with Temperature over T_{op}	$\frac{\Delta R}{R}$	-20	+20	%	From resistance measured at T_0 °C
10	Operating Temperature Range	T_{op}	-20	+70	°C	
11	Frequency variation with Drive Level	$\frac{\Delta f}{f}$	Not applicable		10^{-6}	
12	Resistance variation with Drive Level	$\frac{\Delta R}{R}$	Not applicable		%	
13	Motional Inductance	L_1	Not applicable		mH	
14	Motional Capacitance	C_1	Not applicable		fF	
15	Static Capacitance	C_0	-	7.0	pF	
16	Q Factor	Q	Not applicable		-	
17	Ratio of Unwanted: Response Resistance to Resonance Resistance or Response Impedance to Resonance Resistance	R_p/R or $ Z_p /R$	2:1	-		In the frequency range: $f_r - 60\text{kHz}$ to $f_r + 60\text{kHz}$
18	Ageing	$\frac{\Delta f}{f}$	-3.0	+3.0	10^{-6}	After burn-in, and per year
19	Terminal Length	L	Figure 2		mm	

TABLE 1(a) - TYPE VARIANT DETAILED INFORMATION

TYPE VARIANT NO. 50

No.	Characteristics	Symbol	Limits		Unit	Remarks
			Min.	Max.		
1	Resonance Frequency	f_r	69.619048		MHz	$f_s = 69.6182\text{MHz}$
2	Reference Temperature	T_0	+23	+27	°C	
3	Overtone Order	-	3			
4	Load Capacitance	C_L	∞		pF	
5	Rated Drive Level	P_0	0.1		mW	
6	Frequency Adjustment Tolerance	$\frac{\Delta f}{f}$	-5.0	+5.0	10^{-6}	At T_0 °C
7	Resonance Resistance	R_r	-	40	Ω	At T_0 °C
8	Frequency Variation with Temperature over T_{op}	$\frac{\Delta f}{f}$	-10	+10	10^{-6}	From frequency measured at T_0 °C
9	Resistance Variation with Temperature over T_{op}	$\frac{\Delta R}{R}$	-20	+20	%	From resistance measured at T_0 °C
10	Operating Temperature Range	T_{op}	-20	+70	°C	
11	Frequency variation with Drive Level	$\frac{\Delta f}{f}$	Not applicable		10^{-6}	
12	Resistance variation with Drive Level	$\frac{\Delta R}{R}$	Not applicable		%	
13	Motional Inductance	L_1	Not applicable		mH	
14	Motional Capacitance	C_1	Not applicable		fF	
15	Static Capacitance	C_0	-	7.0	pF	
16	Q Factor	Q	Not applicable		-	
17	Ratio of Unwanted: Response Resistance to Resonance Resistance or Response Impedance to Resonance Resistance	R_p/R or $ Z_p /R$	2:1	-		In the frequency range: $f_r - 60\text{kHz}$ to $f_r + 60\text{kHz}$
18	Ageing	$\frac{\Delta f}{f}$	-3.0	+3.0	10^{-6}	After burn-in, and per year
19	Terminal Length	L	Figure 2		mm	

TABLE 1(a) - TYPE VARIANT DETAILED INFORMATION

TYPE VARIANT NO. 51

No.	Characteristics	Symbol	Limits		Unit	Remarks
			Min.	Max.		
1	Resonance Frequency	f_L	24.68617		MHz	
2	Reference Temperature	T_o	+23	+27	°C	
3	Overtone Order	-	Fundamental			
4	Load Capacitance	C_L	30		pF	
5	Rated Drive Level	P_o	0.1		mW	
6	Frequency Adjustment Tolerance	$\frac{\Delta f}{f}$	-5.0	+5.0	10^{-6}	At T_o °C
7	Resonance Resistance	R_L	-	25	Ω	At T_o °C
8	Frequency Variation with Temperature over T_{op}	$\frac{\Delta f}{f}$	-6.0	+6.0	10^{-6}	From frequency measured at T_o °C
9	Resistance Variation with Temperature over T_{op}	$\frac{\Delta R}{R}$	-20	+20	%	From resistance measured at T_o °C
10	Operating Temperature Range	T_{op}	-20	+70	°C	
11	Frequency variation with Drive Level	$\frac{\Delta f}{f}$	Not applicable		10^{-6}	
12	Resistance variation with Drive Level	$\frac{\Delta R}{R}$	Not applicable		%	
13	Motional Inductance	L_1	Not applicable		mH	
14	Motional Capacitance	C_1	Not applicable		fF	
15	Static Capacitance	C_o	-	7.0	pF	
16	Q Factor	Q	Not applicable		-	
17	Ratio of Unwanted: Response Resistance to Resonance Resistance or Response Impedance to Resonance Resistance	R_p/R or $ Z_p /R$	2:1	-		In the frequency range: $f_L - 200\text{kHz}$ to $f_L + 200\text{kHz}$
18	Ageing	$\frac{\Delta f}{f}$	-3.0	+3.0	10^{-6}	After burn-in, and per year
19	Terminal Length	L	Figure 2		mm	



TABLE 1(a) - TYPE VARIANT DETAILED INFORMATION

TYPE VARIANT NO. 52

No.	Characteristics	Symbol	Limits		Unit	Remarks
			Min.	Max.		
1	Resonance Frequency	f_r	82.53		MHz	$f_s = 82.5292\text{MHz}$
2	Reference Temperature	T_0	+23	+27	°C	
3	Overtone Order	-	3			
4	Load Capacitance	C_L	∞		pF	
5	Rated Drive Level	P_0	0.1		mW	
6	Frequency Adjustment Tolerance	$\frac{\Delta f}{f}$	-5.0	+5.0	10^{-6}	At T_0 °C
7	Resonance Resistance	R_r	-	40	Ω	At T_0 °C
8	Frequency Variation with Temperature over T_{op}	$\frac{\Delta f}{f}$	-10	+10	10^{-6}	From frequency measured at T_0 °C
9	Resistance Variation with Temperature over T_{op}	$\frac{\Delta R}{R}$	-20	+20	%	From resistance measured at T_0 °C
10	Operating Temperature Range	T_{op}	-20	+70	°C	
11	Frequency variation with Drive Level	$\frac{\Delta f}{f}$	Not applicable		10^{-6}	
12	Resistance variation with Drive Level	$\frac{\Delta R}{R}$	Not applicable		%	
13	Motional Inductance	L_1	Not applicable		mH	
14	Motional Capacitance	C_1	Not applicable		fF	
15	Static Capacitance	C_0	-	7.0	pF	
16	Q Factor	Q	Not applicable		-	
17	Ratio of Unwanted: Response Resistance to Resonance Resistance or Response Impedance to Resonance Resistance	R_p/R or $ Z_{pl}/R$	2:1	-		in the frequency range: $f_r - 70\text{kHz}$ to $f_r + 70\text{kHz}$
18	Ageing	$\frac{\Delta f}{f}$	-3.0	+3.0	10^{-6}	After burn-in, and per year
19	Terminal Length	L	Figure 2		mm	



TABLE 1(a) - TYPE VARIANT DETAILED INFORMATION

TYPE VARIANT NO. 53

No.	Characteristics	Symbol	Limits		Unit	Remarks
			Min.	Max.		
1	Resonance Frequency	f_r	83.07		MHz	$f_s = 83.0692\text{MHz}$
2	Reference Temperature	T_0	+23	+27	°C	
3	Overtone Order	-	3			
4	Load Capacitance	C_L	∞		pF	
5	Rated Drive Level	P_0	0.1		mW	
6	Frequency Adjustment Tolerance	$\frac{\Delta f}{f}$	-5.0	+5.0	10^{-6}	At T_0 °C
7	Resonance Resistance	R_r	-	40	Ω	At T_0 °C
8	Frequency Variation with Temperature over T_{op}	$\frac{\Delta f}{f}$	-10	+10	10^{-6}	From frequency measured at T_0 °C
9	Resistance Variation with Temperature over T_{op}	$\frac{\Delta R}{R}$	-20	+20	%	From resistance measured at T_0 °C
10	Operating Temperature Range	T_{op}	-20	+70	°C	
11	Frequency variation with Drive Level	$\frac{\Delta f}{f}$	Not applicable		10^{-6}	
12	Resistance variation with Drive Level	$\frac{\Delta R}{R}$	Not applicable		%	
13	Motional Inductance	L_1	Not applicable		mH	
14	Motional Capacitance	C_1	Not applicable		fF	
15	Static Capacitance	C_0	-	7.0	pF	
16	Q Factor	Q	Not applicable		-	
17	Ratio of Unwanted: Response Resistance to Resonance Resistance or Response Impedance to Resonance Resistance	R_p/R or $ Z_{pi}/R$	2:1	-		In the frequency range: $f_r - 70\text{kHz}$ to $f_r + 70\text{kHz}$
18	Ageing	$\frac{\Delta f}{f}$	-3.0	+3.0	10^{-6}	After burn-in, and per year
19	Terminal Length	L	Figure 2		mm	



TABLE 1(a) - TYPE VARIANT DETAILED INFORMATION

TYPE VARIANT NO. 54

No.	Characteristics	Symbol	Limits		Unit	Remarks
			Min.	Max.		
1	Resonance Frequency	f_r	37.063617		MHz	Swept
2	Reference Temperature	T_0	+23	+27	°C	
3	Overtone Order	-	3			
4	Load Capacitance	C_L	∞		pF	
5	Rated Drive Level	P_0	0.1		mW	
6	Frequency Adjustment Tolerance	$\frac{\Delta f}{f}$	-10	+10	10^{-6}	At T_0 °C
7	Resonance Resistance	R_r	-	40	Ω	At T_0 °C
8	Frequency Variation with Temperature over T_{op}	$\frac{\Delta f}{f}$	-9.0	+9.0	10^{-6}	From frequency measured at T_0 °C
9	Resistance Variation with Temperature over T_{op}	$\frac{\Delta R}{R}$	-10	+10	%	From resistance measured at T_0 °C
10	Operating Temperature Range	T_{op}	-20	+70	°C	
11	Frequency variation with Drive Level	$\frac{\Delta f}{f}$	Not applicable		10^{-6}	
12	Resistance variation with Drive Level	$\frac{\Delta R}{R}$	Not applicable		%	
13	Motional Inductance	L_1	17.3	21.3	mH	
14	Motional Capacitance	C_1	Not applicable		fF	
15	Static Capacitance	C_0	-	7.0	pF	
16	Q Factor	Q	19 000		-	
17	Ratio of Unwanted: Response Resistance to Resonance Resistance or Response Impedance to Resonance Resistance	R_p/R or iZ_{pl}/R	2:1	-		In the frequency range: $f_r - 50\text{kHz}$ to $f_r + 50\text{kHz}$
18	Ageing	$\frac{\Delta f}{f}$	-3.0	+3.0	10^{-6}	After burn-in, and per year
19	Terminal Length	L	Figure 2		mm	



TABLE 1(a) - TYPE VARIANT DETAILED INFORMATION

TYPE VARIANT NO. 55

No.	Characteristics	Symbol	Limits		Unit	Remarks
			Min.	Max.		
1	Resonance Frequency	f_r	37.083333		MHz	
2	Reference Temperature	T_o	+23	+27	°C	
3	Overtone Order	-	3			
4	Load Capacitance	C_L	∞		pF	
5	Rated Drive Level	P_o	0.1		mW	
6	Frequency Adjustment Tolerance	$\frac{\Delta f}{f}$	-10	+10	10^{-6}	At T_o °C
7	Resonance Resistance	R_r	-	40	Ω	At T_o °C
8	Frequency Variation with Temperature over T_{op}	$\frac{\Delta f}{f}$	-9.0	+9.0	10^{-6}	From frequency measured at T_o °C
9	Resistance Variation with Temperature over T_{op}	$\frac{\Delta R}{R}$	-10	+10	%	From resistance measured at T_o °C
10	Operating Temperature Range	T_{op}	-20	+70	°C	
11	Frequency variation with Drive Level	$\frac{\Delta f}{f}$	Not applicable		10^{-6}	
12	Resistance variation with Drive Level	$\frac{\Delta R}{R}$	Not applicable		%	
13	Motional Inductance	L_1	17.3	21.3	mH	
14	Motional Capacitance	C_1	Not applicable		fF	
15	Static Capacitance	C_o	-	7.0	pF	
16	Q Factor	Q	19 000		-	
17	Ratio of Unwanted: Response Resistance to Resonance Resistance or Response Impedance to Resonance Resistance	R_p/R or $ Z_{pl}/R$	2:1	-		In the frequency range: $f_r - 50\text{kHz}$ to $f_r + 50\text{kHz}$
18	Ageing	$\frac{\Delta f}{f}$	-3.0	+3.0	10^{-6}	After burn-in, and per year
19	Terminal Length	L	Figure 2		mm	

TABLE 1(a) - TYPE VARIANT DETAILED INFORMATION

TYPE VARIANT NO. 56

No.	Characteristics	Symbol	Limits		Unit	Remarks
			Min.	Max.		
1	Resonance Frequency	f_r	61.1875		MHz	
2	Reference Temperature	T_o			°C	
3	Overtone Order	-				
4	Load Capacitance	C_L			pF	
5	Rated Drive Level	P_o			mW	
6	Frequency Adjustment Tolerance	$\frac{\Delta f}{f}$			10^{-6}	At T_o °C
7	Resonance Resistance	R_r			Ω	At T_o °C
8	Frequency Variation with Temperature over T_{op}	$\frac{\Delta f}{f}$			10^{-6}	From frequency measured at T_o °C
9	Resistance Variation with Temperature over T_{op}	$\frac{\Delta R}{R}$			%	From resistance measured at T_o °C
10	Operating Temperature Range	T_{op}			°C	
11	Frequency variation with Drive Level	$\frac{\Delta f}{f}$			10^{-6}	From $P_{S1} = \text{mW}$ to $P_{S2} = \text{mW}$
12	Resistance variation with Drive Level	$\frac{\Delta R}{R}$			%	From $P_{S1} = \text{mW}$ to $P_{S2} = \text{mW}$
13	Motional Inductance	L_1			mH	
14	Motional Capacitance	C_1			fF	
15	Static Capacitance	C_o	-		pF	
16	Q Factor	Q		-	-	
17	Ratio of Unwanted: Response Resistance to Resonance Resistance or Response Impedance to Resonance Resistance	R_p/R or $ Z_p /R$			-	In the frequency range: $f_r - \text{kHz}$ to $f_r + \text{kHz}$
18	Ageing	$\frac{\Delta f}{f}$			10^{-6}	
19	Terminal Length	L			mm	



TABLE 1(a) - TYPE VARIANT DETAILED INFORMATION

TYPE VARIANT NO. 57

No.	Characteristics	Symbol	Limits		Unit	Remarks
			Min.	Max.		
1	Resonance Frequency	f_r	65.00311		MHz	Swept
2	Reference Temperature	T_0	+23	+27	°C	
3	Overtone Order	-	3			
4	Load Capacitance	C_L	∞		pF	
5	Rated Drive Level	P_0	0.1		mW	
6	Frequency Adjustment Tolerance	$\frac{\Delta f}{f}$	-10	+10	10^{-6}	At T_0 °C
7	Resonance Resistance	R_r	-	40	Ω	At T_0 °C
8	Frequency Variation with Temperature over T_{op}	$\frac{\Delta f}{f}$	-10	+10	10^{-6}	From frequency measured at T_0 °C
9	Resistance Variation with Temperature over T_{op}	$\frac{\Delta R}{R}$	-10	+10	%	From resistance measured at T_0 °C
10	Operating Temperature Range	T_{op}	-20	+70	°C	
11	Frequency variation with Drive Level	$\frac{\Delta f}{f}$	Not applicable		10^{-6}	
12	Resistance variation with Drive Level	$\frac{\Delta R}{R}$	Not applicable		%	
13	Motional Inductance	L_1	3.2	4.8	mH	
14	Motional Capacitance	C_1	Not applicable		fF	
15	Static Capacitance	C_0	-	7.0	pF	
16	Q Factor	Q	70 000	-	-	
17	Ratio of Unwanted: Response Resistance to Resonance Resistance or Response Impedance to Resonance Resistance	R_p/R or $ Z_{pi}/R$	2:1	-		In the frequency range: $f_r - 50\text{kHz}$ to $f_r + 50\text{kHz}$
18	Ageing	$\frac{\Delta f}{f}$	-3.0	+3.0	10^{-6}	After burn-in, and per year
19	Terminal Length	L	Figure 2		mm	



TABLE 1(a) - TYPE VARIANT DETAILED INFORMATION

TYPE VARIANT NO. 58

No.	Characteristics	Symbol	Limits		Unit	Remarks
			Min.	Max.		
1	Resonance Frequency	f_r	85.48		MHz	Swept
2	Reference Temperature	T_o	+23	+27	°C	
3	Overtone Order	-	5			
4	Load Capacitance	C_L	∞		pF	
5	Rated Drive Level	P_o	0.1		mW	
6	Frequency Adjustment Tolerance	$\frac{\Delta f}{f}$	-5.0	+5.0	10^{-6}	At T_o °C
7	Resonance Resistance	R_r	-	60	Ω	At T_o °C
8	Frequency Variation with Temperature over T_{op}	$\frac{\Delta f}{f}$	-7.5	+7.5	10^{-6}	From frequency measured at T_o °C
9	Resistance Variation with Temperature over T_{op}	$\frac{\Delta R}{R}$	-10	+10	%	From resistance measured at T_o °C
10	Operating Temperature Range	T_{op}	-20	+70	°C	
11	Frequency variation with Drive Level	$\frac{\Delta f}{f}$	Not applicable		10^{-6}	
12	Resistance variation with Drive Level	$\frac{\Delta R}{R}$	Not applicable		%	
13	Motional Inductance	L_1	12	-	mH	
14	Motional Capacitance	C_1	Not applicable		fF	
15	Static Capacitance	C_o	-	7.0	pF	
16	Q Factor	Q	Not applicable		-	
17	Ratio of Unwanted: Response Resistance to Resonance Resistance or Response Impedance to Resonance Resistance	R_p/R or $ Z_p /R$	2:1	-		In the frequency range: $f_r - 50\text{kHz}$ to $f_r + 50\text{kHz}$
18	Ageing	$\frac{\Delta f}{f}$	-2.0	+2.0	10^{-6}	After burn-in, and per year
19	Terminal Length	L	Figure 2		mm	

TABLE 1(a) - TYPE VARIANT DETAILED INFORMATION

TYPE VARIANT NO. 59

No.	Characteristics	Symbol	Limits		Unit	Remarks
			Min.	Max.		
1	Resonance Frequency	f_L	46.08005		MHz	Swept
2	Reference Temperature	T_0	+23	+27	°C	
3	Overtone Order	-	3			
4	Load Capacitance	C_L	12		pF	
5	Rated Drive Level	P_0	0.1		mW	
6	Frequency Adjustment Tolerance	$\frac{\Delta f}{f}$	-5.0	+5.0	10^{-6}	At T_0 °C
7	Resonance Resistance	R_L	-	40	Ω	At T_0 °C
8	Frequency Variation with Temperature over T_{op}	$\frac{\Delta f}{f}$	-10	+10	10^{-6}	From frequency measured at T_0 °C
9	Resistance Variation with Temperature over T_{op}	$\frac{\Delta R}{R}$	-10	+10	%	From resistance measured at T_0 °C
10	Operating Temperature Range	T_{op}	-20	+70	°C	
11	Frequency variation with Drive Level	$\frac{\Delta f}{f}$	Not applicable		10^{-6}	
12	Resistance variation with Drive Level	$\frac{\Delta R}{R}$	Not applicable		%	
13	Motional Inductance	L_1	17.42	23.57	mH	
14	Motional Capacitance	C_1	Not applicable		fF	
15	Static Capacitance	C_0	-	7.0	pF	
16	Q Factor	Q	50 000		-	
17	Ratio of Unwanted: Response Resistance to Resonance Resistance or Response Impedance to Resonance Resistance	R_p/R or $ Z_p /R$	2:1	-		In the frequency range: $f_L - 50\text{kHz}$ to $f_L + 50\text{kHz}$
18	Ageing	$\frac{\Delta f}{f}$	-3.0	+3.0	10^{-6}	After burn-in, and per year
19	Terminal Length	L	Figure 2		mm	



TABLE 1(a) - TYPE VARIANT DETAILED INFORMATION

TYPE VARIANT NO. 60

No.	Characteristics	Symbol	Limits		Unit	Remarks
			Min.	Max.		
1	Resonance Frequency	f_L	16.0		MHz	
2	Reference Temperature	T_o	+60		°C	
3	Overtone Order	-	Fundamental			
4	Load Capacitance	C_L	22		pF	
5	Rated Drive Level	P_o	0.1		mW	
6	Frequency Adjustment Tolerance	$\frac{\Delta f}{f}$	-10	+10	10^{-6}	At T_o °C
7	Resonance Resistance	R_L	-	13	Ω	Over T_{op} °C
8	Frequency Variation with Temperature over T_{op}	$\frac{\Delta f}{f}$	-15	+15	10^{-6}	From frequency measured at T_o °C
9	Resistance Variation with Temperature over T_{op}	$\frac{\Delta R}{R}$	Not applicable		%	
10	Operating Temperature Range	T_{op}	-20	+70	°C	
11	Frequency variation with Drive Level	$\frac{\Delta f}{f}$	Not applicable		10^{-6}	
12	Resistance variation with Drive Level	$\frac{\Delta R}{R}$	Not applicable		%	
13	Motional Inductance	L_1	Not applicable		mH	
14	Motional Capacitance	C_1	Not applicable		fF	
15	Static Capacitance	C_o	-	5.0	pF	
16	Q Factor	Q	50 000		-	
17	Ratio of Unwanted: Response Resistance to Resonance Resistance or Response Impedance to Resonance Resistance	R_p/R or $ Z_p /R$	3:1		-	In the frequency range: $f_L - 200\text{kHz}$ to $f_L + 200\text{kHz}$
18	Ageing	$\frac{\Delta f}{f}$	-3.0	+3.0	10^{-6}	After burn-in, and per year
19	Terminal Length	L	Figure 2		mm	



TABLE 1(a) - TYPE VARIANT DETAILED INFORMATION

TYPE VARIANT NO. 61

No.	Characteristics	Symbol	Limits		Unit	Remarks
			Min.	Max.		
1	Resonance Frequency	f_r	38.3117284		MHz	
2	Reference Temperature	T_0	+25		°C	
3	Overtone Order	-	3			
4	Load Capacitance	C_L	∞		pF	
5	Rated Drive Level	P_0	0.1		mW	
6	Frequency Adjustment Tolerance	$\frac{\Delta f}{f}$	-5.0	+5.0	10^{-6}	At T_0 °C
7	Resonance Resistance	R_r	-	40	Ω	At T_0 °C
8	Frequency Variation with Temperature over T_{op}	$\frac{\Delta f}{f}$	+7.0	-7.0	10^{-6}	From frequency measured at T_0 °C
9	Resistance Variation with Temperature over T_{op}	$\frac{\Delta R}{R}$	-20	+20	%	From resistance measured at T_0 °C
10	Operating Temperature Range	T_{op}	-20	+60	°C	
11	Frequency variation with Drive Level	$\frac{\Delta f}{f}$	Not applicable		10^{-6}	
12	Resistance variation with Drive Level	$\frac{\Delta R}{R}$	Not applicable		%	
13	Motional Inductance	L_1	Not applicable		mH	
14	Motional Capacitance	C_1	Not applicable		fF	
15	Static Capacitance	C_0	-	5.0	pF	
16	Q Factor	Q	Not applicable		-	
17	Ratio of Unwanted: Response Resistance to Resonance Resistance or Response Impedance to Resonance Resistance	R_p/R or $ Z_p /R$	3:1	-		In the frequency range: $f_r - 60\text{kHz}$ to $f_r + 60\text{kHz}$
18	Ageing	$\frac{\Delta f}{f}$	-3.0	+3.0	10^{-6}	After burn-in, and per year
19	Terminal Length	L	Figure 2		mm	



TABLE 1(a) - TYPE VARIANT DETAILED INFORMATION

TYPE VARIANT NO. 62

No.	Characteristics	Symbol	Limits		Unit	Remarks
			Min.	Max.		
1	Resonance Frequency	f_L	15.0		MHz	
2	Reference Temperature	T_o	+60		°C	
3	Overtone Order	-	Fundamental			
4	Load Capacitance	C_L	20	50	pF	
5	Rated Drive Level	P_o	0.1		mW	
6	Frequency Adjustment Tolerance	$\frac{\Delta f}{f}$	-10	+10	10^{-6}	At T_o °C
7	Resonance Resistance	R_L	-	20	Ω	At T_o °C
8	Frequency Variation with Temperature over T_{op}	$\frac{\Delta f}{f}$	-10	+10	10^{-6}	From frequency measured at T_o °C
9	Resistance Variation with Temperature over T_{op}	$\frac{\Delta R}{R}$	-10	+10	%	From resistance measured at T_o °C If $R < 10\Omega$
			-1.5	+1.5		
10	Operating Temperature Range	T_{op}	-30	+70	°C	
11	Frequency variation with Drive Level	$\frac{\Delta f}{f}$	Not applicable		10^{-6}	
12	Resistance variation with Drive Level	$\frac{\Delta R}{R}$	Not applicable		%	
13	Motional Inductance	L_1	10.2	13.8	mH	
14	Motional Capacitance	C_1	Not applicable		fF	
15	Static Capacitance	C_o	-	7.0	pF	
16	Q Factor	Q	70 000	-	-	
17	Ratio of Unwanted: Response Resistance to Resonance Resistance or Response Impedance to Resonance Resistance	R_p/R or iZ_p/R	2:1	-		In the frequency range: $f_L - 200kHz$ to $f_L + 200kHz$
18	Ageing	$\frac{\Delta f}{f}$	-5.0	+5.0	10^{-6}	After burn-in, and per year
19	Terminal Length	L	Figure 2		mm	

TABLE 1(a) - TYPE VARIANT DETAILED INFORMATION

TYPE VARIANT NO. 63

No.	Characteristics	Symbol	Limits		Unit	Remarks
			Min.	Max.		
1	Resonance Frequency	f_L	16.0		MHz	
2	Reference Temperature	T_0	+59	+61	°C	
3	Overtone Order	-	Fundamental			
4	Load Capacitance	C_L	22		pF	
5	Rated Drive Level	P_0	0.1		mW	
6	Frequency Adjustment Tolerance	$\frac{\Delta f}{f}$	-10	+10	10^{-6}	At T_0 °C
7	Resonance Resistance	R_L	-	13	Ω	At T_0 °C
8	Frequency Variation with Temperature over T_{op}	$\frac{\Delta f}{f}$	-15	+15	10^{-6}	From frequency measured at T_0 °C
9	Resistance Variation with Temperature over T_{op}	$\frac{\Delta R}{R}$	-10	+10	%	From resistance measured at T_0 °C If $R < 10\Omega$
			or -1.5	+1.5	Ω	
10	Operating Temperature Range	T_{op}	-20	+70	°C	
11	Frequency variation with Drive Level	$\frac{\Delta f}{f}$	Not applicable		10^{-6}	
12	Resistance variation with Drive Level	$\frac{\Delta R}{R}$	Not applicable		%	
13	Motional Inductance	L_1	Not applicable		mH	
14	Motional Capacitance	C_1	Not applicable		fF	
15	Static Capacitance	C_0	-	5.0	pF	
16	Q Factor	Q	50 000	-	-	
17	Ratio of Unwanted: Response Resistance to Resonance Resistance or Response Impedance to Resonance Resistance	R_p/R or $ Z_p /R$	3:1	-		In the frequency range: $f_L - 200\text{kHz}$ to $f_L + 200\text{kHz}$
18	Ageing	$\frac{\Delta f}{f}$	-3.0	+3.0	10^{-6}	After burn-in and per year
19	Terminal Length	L	Figure 2		mm	



TABLE 1(a) - TYPE VARIANT DETAILED INFORMATION

TYPE VARIANT NO. 64

No.	Characteristics	Symbol	Limits		Unit	Remarks
			Min.	Max.		
1	Resonance Frequency	f_L	16.384		MHz	Swept
2	Reference Temperature	T_0	+59	+61	°C	
3	Overtone Order	-	Fundamental			
4	Load Capacitance	C_L	22		pF	
5	Rated Drive Level	P_0	0.1		mW	
6	Frequency Adjustment Tolerance	$\frac{\Delta f}{f}$	-10	+10	10^{-6}	At T_0 °C
7	Resonance Resistance	R_L	-	13	Ω	At T_0 °C
8	Frequency Variation with Temperature over T_{op}	$\frac{\Delta f}{f}$	-15	+15	10^{-6}	From frequency measured at T_0 °C
9	Resistance Variation with Temperature over T_{op}	$\frac{\Delta R}{R}$	-10	+10	%	From resistance measured at T_0 °C if $R < 10\Omega$
			-1.5	+1.5	Ω	
10	Operating Temperature Range	T_{op}	-20	+70	°C	
11	Frequency variation with Drive Level	$\frac{\Delta f}{f}$	Not applicable		10^{-6}	
12	Resistance variation with Drive Level	$\frac{\Delta R}{R}$	Not applicable		%	
13	Motional Inductance	L_1	Not applicable		mH	
14	Motional Capacitance	C_1	Not applicable		fF	
15	Static Capacitance	C_0	-	5.0	pF	
16	Q Factor	Q	50 000	-	-	
17	Ratio of Unwanted: Response Resistance to Resonance Resistance or Response Impedance to Resonance Resistance	R_p/R or $ Z_p /R$	3:1	-		In the frequency range: $f_L - 200\text{kHz}$ to $f_L + 200\text{kHz}$
18	Ageing	$\frac{\Delta f}{f}$	-3.0	+3.0	10^{-6}	After burn-in and per year
19	Terminal Length	L	Figure 2		mm	



TABLE 1(a) - TYPE VARIANT DETAILED INFORMATION

TYPE VARIANT NO. 65

No.	Characteristics	Symbol	Limits		Unit	Remarks
			Min.	Max.		
1	Resonance Frequency	f_r	65.0047		MHz	Swept
2	Reference Temperature	T_0	+23	+27	°C	
3	Overtone Order	-	3			
4	Load Capacitance	C_L	∞		pF	
5	Rated Drive Level	P_0	0.1		mW	
6	Frequency Adjustment Tolerance	$\frac{\Delta f}{f}$	-5.0	+5.0	10^{-6}	At T_0 °C
7	Resonance Resistance	R_r	-	40	Ω	At T_0 °C
8	Frequency Variation with Temperature over T_{op}	$\frac{\Delta f}{f}$	-10	+10	10^{-6}	From frequency measured at T_0 °C
9	Resistance Variation with Temperature over T_{op}	$\frac{\Delta R}{R}$	-20	+20	%	From resistance measured at T_0 °C
10	Operating Temperature Range	T_{op}	-20	+70	°C	
11	Frequency variation with Drive Level	$\frac{\Delta f}{f}$	Not applicable		10^{-6}	
12	Resistance variation with Drive Level	$\frac{\Delta R}{R}$	Not applicable		%	
13	Motional Inductance	L_1	Not applicable		mH	
14	Motional Capacitance	C_1	Not applicable		fF	
15	Static Capacitance	C_0	-	7.0	pF	
16	Q Factor	Q	Not applicable		-	
17	Ratio of Unwanted: Response Resistance to Resonance Resistance or Response Impedance to Resonance Resistance	R_p/R or $ Z_{pl}/R$	2:1	-		In the frequency range: $f_r - 60\text{kHz}$ to $f_r + 60\text{kHz}$
18	Ageing	$\frac{\Delta f}{f}$	-3.0	+3.0	10^{-6}	After burn-in, and per year
19	Terminal Length	L	Figure 2		mm	



TABLE 1(a) - TYPE VARIANT DETAILED INFORMATION

TYPE VARIANT NO. 66

No.	Characteristics	Symbol	Limits		Unit	Remarks
			Min.	Max.		
1	Resonance Frequency	f_r	65.0513		MHz	
2	Reference Temperature	T_0	+23	+27	°C	
3	Overtone Order	-	3			
4	Load Capacitance	C_L	∞		pF	
5	Rated Drive Level	P_0	0.1		mW	
6	Frequency Adjustment Tolerance	$\frac{\Delta f}{f}$	-5.0	+5.0	10^{-6}	At T_0 °C
7	Resonance Resistance	R_r	-	40	Ω	At T_0 °C
8	Frequency Variation with Temperature over T_{op}	$\frac{\Delta f}{f}$	-10	+10	10^{-6}	From frequency measured at T_0 °C
9	Resistance Variation with Temperature over T_{op}	$\frac{\Delta R}{R}$	-20	+20	%	From resistance measured at T_0 °C
10	Operating Temperature Range	T_{op}	-20	+70	°C	
11	Frequency variation with Drive Level	$\frac{\Delta f}{f}$	Not applicable		10^{-6}	
12	Resistance variation with Drive Level	$\frac{\Delta R}{R}$	Not applicable		%	
13	Motional Inductance	L_1	Not applicable		mH	
14	Motional Capacitance	C_1	Not applicable		fF	
15	Static Capacitance	C_0	-	7.0	pF	
16	Q Factor	Q	Not applicable		-	
17	Ratio of Unwanted: Response Resistance to Resonance Resistance or Response Impedance to Resonance Resistance	R_p/R or $ Z_p /R$	2:1	-		In the frequency range: $f_r - 50\text{kHz}$ to $f_r + 50\text{kHz}$
18	Ageing	$\frac{\Delta f}{f}$	-3.0	+3.0	10^{-6}	After burn-in, and per year
19	Terminal Length	L	Figure 2		mm	



TABLE 1(a) - TYPE VARIANT DETAILED INFORMATION

TYPE VARIANT NO. 67.

No.	Characteristics	Symbol	Limits		Unit	Remarks
			Min.	Max.		
1	Resonance Frequency	f_r	69.9992		MHz	
2	Reference Temperature	T_0	+23	+27	°C	
3	Overtone Order	-	3			
4	Load Capacitance	C_L	∞		pF	
5	Rated Drive Level	P_0	0.1		mW	
6	Frequency Adjustment Tolerance	$\frac{\Delta f}{f}$	-5.0	+5.0	10^{-6}	At T_0 °C
7	Resonance Resistance	R_r	-	40	Ω	At T_0 °C
8	Frequency Variation with Temperature over T_{op}	$\frac{\Delta f}{f}$	-10	+10	10^{-6}	From frequency measured at T_0 °C
9	Resistance Variation with Temperature over T_{op}	$\frac{\Delta R}{R}$	-20	+20	%	From resistance measured at T_0 °C
10	Operating Temperature Range	T_{op}	-20	+70	°C	
11	Frequency variation with Drive Level	$\frac{\Delta f}{f}$	Not applicable		10^{-6}	
12	Resistance variation with Drive Level	$\frac{\Delta R}{R}$	Not applicable		%	
13	Motional Inductance	L_1	Not applicable		mH	
14	Motional Capacitance	C_1	Not applicable		fF	
15	Static Capacitance	C_0	-	7.0	pF	
16	Q Factor	Q	Not applicable		-	
17	Ratio of Unwanted: Response Resistance to Resonance Resistance or Response Impedance to Resonance Resistance	R_p/R or $ Z_p/R$	2:1	-		In the frequency range: $f_r - 60\text{kHz}$ to $f_r + 60\text{kHz}$
18	Ageing	$\frac{\Delta f}{f}$	-3.0	+3.0	10^{-6}	After burn-in, and per year
19	Terminal Length	L	Figure 2		mm	



TABLE 1(a) - TYPE VARIANT DETAILED INFORMATION

TYPE VARIANT NO. 68

No.	Characteristics	Symbol	Limits		Unit	Remarks
			Min.	Max.		
1	Resonance Frequency	f_r	85.4792		MHz	
2	Reference Temperature	T_o	+23	+27	°C	
3	Overtone Order	-	3			
4	Load Capacitance	C_L	∞		pF	
5	Rated Drive Level	P_o	0.1		mW	
6	Frequency Adjustment Tolerance	$\frac{\Delta f}{f}$	-5.0	+5.0	10^{-6}	At T_o °C
7	Resonance Resistance	R_r	-	40	Ω	At T_o °C
8	Frequency Variation with Temperature over T_{op}	$\frac{\Delta f}{f}$	+10	-10	10^{-6}	From frequency measured at T_o °C
9	Resistance Variation with Temperature over T_{op}	$\frac{\Delta R}{R}$	-20	+20	%	From resistance measured at T_o °C
10	Operating Temperature Range	T_{op}	-20	+70	°C	
11	Frequency variation with Drive Level	$\frac{\Delta f}{f}$	Not applicable		10^{-6}	
12	Resistance variation with Drive Level	$\frac{\Delta R}{R}$	Not applicable		%	
13	Motional Inductance	L_1	Not applicable		mH	
14	Motional Capacitance	C_1	Not applicable		fF	
15	Static Capacitance	C_o	-	7.0	pF	
16	Q Factor	Q	Not applicable		-	
17	Ratio of Unwanted: Response Resistance to Resonance Resistance or Response Impedance to Resonance Resistance	R_p/R or $ Z_p /R$	2:1	-		in the frequency range: $f_r - 60\text{kHz}$ to $f_r + 60\text{kHz}$
18	Ageing	$\frac{\Delta f}{f}$	-3.0	+3.0	10^{-6}	After burn-in, and per year
19	Terminal Length	L	Figure 2		mm	



TABLE 1(a) - TYPE VARIANT DETAILED INFORMATION
TYPE VARIANT NO. 69

No.	Characteristics	Symbol	Limits		Unit	Remarks
			Min.	Max.		
1	Resonance Frequency	f_L	50.0		MHz	
2	Reference Temperature	T_0	+24.9	+25.1	°C	
3	Overtone Order	-	3			
4	Load Capacitance	C_L	30		pF	
5	Rated Drive Level	P_0	1.0		mW	
6	Frequency Adjustment Tolerance	$\frac{\Delta f}{f}$	-5.0	+5.0	10^{-6}	At T_0 °C
7	Resonance Resistance	R_L	-	50	Ω	Over T_{op} °C
8	Frequency Variation with Temperature over T_{op}	$\frac{\Delta f}{f}$	-5.0	+5.0	10^{-6}	From frequency measured at T_0 °C
9	Resistance Variation with Temperature over T_{op}	$\frac{\Delta R}{R}$	Not applicable		%	
10	Operating Temperature Range	T_{op}	-5	+55	°C	
11	Frequency variation with Drive Level	$\frac{\Delta f}{f}$	Not applicable		10^{-6}	
12	Resistance variation with Drive Level	$\frac{\Delta R}{R}$	Not applicable		%	
13	Motional Inductance	L_1	Not applicable		mH	
14	Motional Capacitance	C_1	0.7	0.86	fF	
15	Static Capacitance	C_0	-	3.0	pF	
16	Q Factor	Q	100 000	-	-	
17	Ratio of Unwanted: Response Resistance to Resonance Resistance or Response Impedance to Resonance Resistance	R_p/R $ Z_{pl}/R$	8:1	-		In the frequency range: $f_L - 10\text{MHz}$ to $f_L + 10\text{MHz}$
18	Ageing	$\frac{\Delta f}{f}$	-10	+10	10^{-6}	After a run-in time of 680 hours, over 7 years
19	Terminal Length	L	Figure 2		mm	



TABLE 1(a) - TYPE VARIANT DETAILED INFORMATION

TYPE VARIANT NO. 70

No.	Characteristics	Symbol	Limits		Unit	Remarks
			Min.	Max.		
1	Resonance Frequency	f_L	20.0		MHz	
2	Reference Temperature	T_0	+59	+61	°C	
3	Overtone Order	-	Fundamental			
4	Load Capacitance	C_L	22		pF	
5	Rated Drive Level	P_0	0.1		mW	
6	Frequency Adjustment Tolerance	$\frac{\Delta f}{f}$	-10	+10	10^{-6}	At T_0 °C
7	Resonance Resistance	R_L	-	13	Ω	At T_0 °C
8	Frequency Variation with Temperature over T_{op}	$\frac{\Delta f}{f}$	-15	+15	10^{-6}	From frequency measured at T_0 °C
9	Resistance Variation with Temperature over T_{op}	$\frac{\Delta R}{R}$	-10	+10	%	From resistance measured at T_0 °C
			-1.5	+1.5	Ω	If $R < 10\Omega$
10	Operating Temperature Range	T_{op}	-20	+70	°C	
11	Frequency variation with Drive Level	$\frac{\Delta f}{f}$	Not applicable		10^{-6}	
12	Resistance variation with Drive Level	$\frac{\Delta R}{R}$	Not applicable		%	
13	Motional Inductance	L_1	Not applicable		mH	
14	Motional Capacitance	C_1	Not applicable		fF	
15	Static Capacitance	C_0	-	4.5	pF	
16	Q Factor	Q	50 000	-	-	
17	Ratio of Unwanted: Response Resistance to Resonance Resistance or Response Impedance to Resonance Resistance	R_p/R or $ Z_p /R$	3:1	-		In the frequency range: $f_L - 200\text{kHz}$ to $f_L + 200\text{kHz}$
18	Ageing	$\frac{\Delta f}{f}$	-3.0	+3.0	10^{-6}	After burn-in and per year
19	Terminal Length	L	Figure 2		mm	

TABLE 1(a) - TYPE VARIANT DETAILED INFORMATION

TYPE VARIANT NO. 71

No.	Characteristics	Symbol	Limits		Unit	Remarks
			Min.	Max.		
1	Resonance Frequency	f_L	8.0		MHz	
2	Reference Temperature	T_0	+23	+27	°C	
3	Overtone Order	-	Fundamental			
4	Load Capacitance	C_L	29.7	30.3	pF	
5	Rated Drive Level	P_0	0.1		mW	
6	Frequency Adjustment Tolerance	$\frac{\Delta f}{f}$	-10	+10	10^{-6}	At T_0 °C
7	Resonance Resistance	R_L	-	30	Ω	At T_0 °C
8	Frequency Variation with Temperature over T_{op}	$\frac{\Delta f}{f}$	-30	+30	10^{-6}	From frequency measured at T_0 °C
9	Resistance Variation with Temperature over T_{op}	$\frac{\Delta R}{R}$	-10	+10	%	From resistance measured at T_0 °C If $R < 10\Omega$
			-1.5	+1.5	Ω	
10	Operating Temperature Range	T_{op}	-35	+105	°C	
11	Frequency variation with Drive Level	$\frac{\Delta f}{f}$	-2.0	+2.0	10^{-6}	From $P_{S1} = 20nW$ to $P_{S2} = 0.2mW$
12	Resistance variation with Drive Level	$\frac{\Delta R}{R}$	-25	+25	%	From $P_{S1} = 20nW$ to $P_{S2} = 0.2mW$
13	Motional Inductance	L_1	45	55	mH	
14	Motional Capacitance	C_1	7.2	8.8	fF	
15	Static Capacitance	C_0	2.75	3.75	pF	
16	Q Factor	Q	92 100	-	-	
17	Ratio of Unwanted: Response Resistance to Resonance Resistance or Response Impedance to Resonance Resistance	R_p/R or $ Z_p /R$	2:1	-		In the frequency range: $f_L - 500kHz$ to $f_L + 500kHz$
18	Ageing	$\frac{\Delta f}{f}$	-5.0	+5.0	10^{-6}	After burn-in, over 10 years
19	Terminal Length	L	Figure 2		mm	



TABLE 1(a) - TYPE VARIANT DETAILED INFORMATION

TYPE VARIANT NO. 72

No.	Characteristics	Symbol	Limits		Unit	Remarks
			Min.	Max.		
1	Resonance Frequency	f_r	32.74375		MHz	
2	Reference Temperature	T_0	+24	+26	°C	
3	Overtone Order	-	3			
4	Load Capacitance	C_L	∞		pF	
5	Rated Drive Level	P_0	0.1		mW	
6	Frequency Adjustment Tolerance	$\frac{\Delta f}{f}$	-5.0	+5.0	10^{-6}	At T_0 °C
7	Resonance Resistance	R_r	-	40	Ω	At T_0 °C
8	Frequency Variation with Temperature over T_{op}	$\frac{\Delta f}{f}$	-9.0	+9.0	10^{-6}	From frequency measured at T_0 °C
9	Resistance Variation with Temperature over T_{op}	$\frac{\Delta R}{R}$	-10	+10	%	From resistance measured at T_0 °C
10	Operating Temperature Range	T_{op}	-20	+70	°C	
11	Frequency variation with Drive Level	$\frac{\Delta f}{f}$	Not applicable		10^{-6}	
12	Resistance variation with Drive Level	$\frac{\Delta R}{R}$	Not applicable		%	
13	Motional Inductance	L_1	15	22	mH	
14	Motional Capacitance	C_1	Not applicable		fF	
15	Static Capacitance	C_0	-	7.0	pF	
16	Q Factor	Q	90 000	-	-	
17	Ratio of Unwanted: Response Resistance to Resonance Resistance or Response Impedance to Resonance Resistance	R_p/R or $ Z_p /R$	2:1	-		In the frequency range: $f_r - 50\text{kHz}$ to $f_r + 50\text{kHz}$
18	Ageing	$\frac{\Delta f}{f}$	-3.0	+3.0	10^{-6}	After burn-in, and per year
19	Terminal Length	L	Figure 2		mm	

TABLE 1(a) - TYPE VARIANT DETAILED INFORMATION

TYPE VARIANT NO. 73

No.	Characteristics	Symbol	Limits		Unit	Remarks
			Min.	Max.		
1	Resonance Frequency	f_r	37.827083		MHz	
2	Reference Temperature	T_o	+24	+26	°C	
3	Overtone Order	-	3			
4	Load Capacitance	C_L	∞		pF	
5	Rated Drive Level	P_o	0.1		mW	
6	Frequency Adjustment Tolerance	$\frac{\Delta f}{f}$	-5.0	+5.0	10^{-6}	At T_o °C
7	Resonance Resistance	R_r	-	40	Ω	At T_o °C
8	Frequency Variation with Temperature over T_{op}	$\frac{\Delta f}{f}$	-9.0	+9.0	10^{-6}	From frequency measured at T_o °C
9	Resistance Variation with Temperature over T_{op}	$\frac{\Delta R}{R}$	-10	+10	%	From resistance measured at T_o °C
10	Operating Temperature Range	T_{op}	-20	+70	°C	
11	Frequency variation with Drive Level	$\frac{\Delta f}{f}$	Not applicable		10^{-6}	
12	Resistance variation with Drive Level	$\frac{\Delta R}{R}$	Not applicable		%	
13	Motional Inductance	L_1	15	22	mH	
14	Motional Capacitance	C_1	Not applicable		fF	
15	Static Capacitance	C_o	-	7.0	pF	
16	Q Factor	Q	90 000	-	-	
17	Ratio of Unwanted: Response Resistance to Resonance Resistance or Response Impedance to Resonance Resistance	R_p/R or iZ_p/R	2:1	-		In the frequency range: $f_r - 50\text{kHz}$ to $f_r + 50\text{kHz}$
18	Ageing	$\frac{\Delta f}{f}$	-3.0	+3.0	10^{-6}	After burn-in, and per year
19	Terminal Length	L	Figure 2		mm	

TABLE 1(a) - TYPE VARIANT DETAILED INFORMATION

TYPE VARIANT NO. 74

No.	Characteristics	Symbol	Limits		Unit	Remarks
			Min.	Max.		
1	Resonance Frequency	f_L	5.24288		MHz	
2	Reference Temperature	T_0	+23	+27	°C	
3	Overtone Order	-	Fundamental			
4	Load Capacitance	C_L	29.7	30.3	pF	
5	Rated Drive Level	P_0	0.1		mW	
6	Frequency Adjustment Tolerance	$\frac{\Delta f}{f}$	-10	+10	10^{-6}	At T_0 °C
7	Resonance Resistance	R_L	-	110	Ω	At T_0 °C
8	Frequency Variation with Temperature over T_{op}	$\frac{\Delta f}{f}$	+30	-30	10^{-6}	From frequency measured at T_0 °C
9	Resistance Variation with Temperature over T_{op}	$\frac{\Delta R}{R}$	-25	+25	%	From resistance measured at T_0 °C
10	Operating Temperature Range	T_{op}	-25	+105	°C	
11	Frequency variation with Drive Level	$\frac{\Delta f}{f}$	-2.0	+2.0	10^{-6}	From $P_{S1} = 20nW$ to $P_{S2} = 0.2mW$
12	Resistance variation with Drive Level	$\frac{\Delta R}{R}$	-25	+25	%	From $P_{S1} = 20nW$ to $P_{S2} = 0.2mW$
13	Motional Inductance	L_1	138	168	mH	
14	Motional Capacitance	C_1	5.42	6.62	fF	
15	Static Capacitance	C_0	1.84	2.24	pF	
16	Q Factor	Q	41 300	-	-	
17	Ratio of Unwanted: Response Resistance to Resonance Resistance or Response Impedance to Resonance Resistance	R_p/R or $ Z_p /R$	2:1	-		In the frequency range: $f_L - 500kHz$ to $f_L + 500kHz$
18	Ageing	$\frac{\Delta f}{f}$	-3.0	+3.0	10^{-6}	After burn-in, over 10 years
19	Terminal Length	L	Figure 2		mm	



TABLE 1(a) - TYPE VARIANT DETAILED INFORMATION

TYPE VARIANT NO. 75

No.	Characteristics	Symbol	Limits		Unit	Remarks
			Min.	Max.		
1	Resonance Frequency	f_L	4.096		MHz	
2	Reference Temperature	T_0	+23	+27	°C	
3	Overtone Order	-	Fundamental			
4	Load Capacitance	C_L	29.7	30.3	pF	
5	Rated Drive Level	P_0	0.1		mW	
6	Frequency Adjustment Tolerance	$\frac{\Delta f}{f}$	-10	+10	10^{-6}	At T_0 °C
7	Resonance Resistance	R_L	-	75	Ω	At T_0 °C
8	Frequency Variation with Temperature over T_{op}	$\frac{\Delta f}{f}$	-25	+25	10^{-6}	From frequency measured at T_0 °C
9	Resistance Variation with Temperature over T_{op}	$\frac{\Delta R}{R}$	-25	+25	%	From resistance measured at T_0 °C
10	Operating Temperature Range	T_{op}	-25	+75	°C	
11	Frequency variation with Drive Level	$\frac{\Delta f}{f}$	-2.0	+2.0	10^{-6}	From $P_{S1} = 20nW$ to $P_{S2} = 0.2mW$
12	Resistance variation with Drive Level	$\frac{\Delta R}{R}$	-25	+25	%	From $P_{S1} = 20nW$ to $P_{S2} = 0.2mW$
13	Motional Inductance	L_1	313	348	mH	
14	Motional Capacitance	C_1	4.34	4.82	fF	
15	Static Capacitance	C_0	1.66	2.04	pF	
16	Q Factor	Q	107 000	-	-	
17	Ratio of Unwanted: Response Resistance to Resonance Resistance or Response Impedance to Resonance Resistance	R_p/R or $ Z_p /R$	2:1	-		In the frequency range: $f_L -500kHz$ to $f_L +500kHz$
18	Ageing	$\frac{\Delta f}{f}$	-5.0	+5.0	10^{-6}	After burn-in, over 10 years
19	Terminal Length	L	Figure 2		mm	



TABLE 1(a) - TYPE VARIANT DETAILED INFORMATION

TYPE VARIANT NO. 76

No.	Characteristics	Symbol	Limits		Unit	Remarks
			Min.	Max.		
1	Resonance Frequency	f_L	5.12		MHz	
2	Reference Temperature	T_0	+23	+27	°C	
3	Overtone Order	-	Fundamental			
4	Load Capacitance	C_L	29.7	30.3	pF	
5	Rated Drive Level	P_0	0.1		mW	
6	Frequency Adjustment Tolerance	$\frac{\Delta f}{f}$	-10	+10	10^{-6}	At T_0 °C
7	Resonance Resistance	R_L	-	110	Ω	At T_0 °C
8	Frequency Variation with Temperature over T_{op}	$\frac{\Delta f}{f}$	-30	+30	10^{-6}	From frequency measured at T_0 °C
9	Resistance Variation with Temperature over T_{op}	$\frac{\Delta R}{R}$	-25	+25	%	From resistance measured at T_0 °C
10	Operating Temperature Range	T_{op}	-35	+105	°C	
11	Frequency variation with Drive Level	$\frac{\Delta f}{f}$	-2.0	+2.0	10^{-6}	From $P_{S1} = 20nW$ to $P_{S2} = 0.2mW$
12	Resistance variation with Drive Level	$\frac{\Delta R}{R}$	-25	+25	%	From $P_{S1} = 20nW$ to $P_{S2} = 0.2mW$
13	Motional Inductance	L_1	146.7	179.3	mH	
14	Motional Capacitance	C_1	5.3	6.5	fF	
15	Static Capacitance	C_0	1.8	2.2	pF	
16	Q Factor	Q	47 896	-	-	
17	Ratio of Unwanted: Response Resistance to Resonance Resistance or Response Impedance to Resonance Resistance	R_p/R or $ Z_{pl}/R$	2:1	-		In the frequency range: $f_L - 500kHz$ to $f_L + 500kHz$
18	Ageing	$\frac{\Delta f}{f}$	-5.0	+5.0	10^{-6}	After burn-in, over 10 years
19	Terminal Length	L	Figure 2		mm	

TABLE 1(a) - TYPE VARIANT DETAILED INFORMATION

TYPE VARIANT NO. 77

No.	Characteristics	Symbol	Limits		Unit	Remarks
			Min.	Max.		
1	Resonance Frequency	f_L	6.5536		MHz	
2	Reference Temperature	T_0	+23	+27	°C	
3	Overtone Order	-	Fundamental			
4	Load Capacitance	C_L	29.7	30.3	pF	
5	Rated Drive Level	P_0	0.1		mW	
6	Frequency Adjustment Tolerance	$\frac{\Delta f}{f}$	-10	+10	10^{-6}	At T_0 °C
7	Resonance Resistance	R_L	-	70	Ω	At T_0 °C
8	Frequency Variation with Temperature over T_{op}	$\frac{\Delta f}{f}$	-30	+30	10^{-6}	From frequency measured at T_0 °C
9	Resistance Variation with Temperature over T_{op}	$\frac{\Delta R}{R}$	-25	+25	%	From resistance measured at T_0 °C
10	Operating Temperature Range	T_{op}	-35	+105	°C	
11	Frequency variation with Drive Level	$\frac{\Delta f}{f}$	-2.0	+2.0	10^{-6}	From $P_{S1} = ?mW$ to $P_{S2} = ?mW$
12	Resistance variation with Drive Level	$\frac{\Delta R}{R}$	-25	+25	%	From $P_{S1} = ?mW$ to $P_{S2} = ?mW$
13	Motional Inductance	L_1	64.6	79.0	mH	
14	Motional Capacitance	C_1	7.47	9.13	fF	
15	Static Capacitance	C_0	2.28	2.78	pF	
16	Q Factor	Q	48 860	-	-	
17	Ratio of Unwanted: Response Resistance to Resonance Resistance or Response Impedance to Resonance Resistance	R_p/R or $ Z_p /R$	2:1	-		In the frequency range: $f_L - 500kHz$ to $f_L + 500kHz$
18	Ageing	$\frac{\Delta f}{f}$	-5.0	+5.0	10^{-6}	After burn-in, over 10 years
19	Terminal Length	L	Figure 2		mm	

TABLE 1(a) - TYPE VARIANT DETAILED INFORMATION

TYPE VARIANT NO. 78

No.	Characteristics	Symbol	Limits		Unit	Remarks
			Min.	Max.		
1	Resonance Frequency	f_r	65.04974		MHz	Swept
2	Reference Temperature	T_o	+23	+27	°C	
3	Overtone Order	-	3			
4	Load Capacitance	C_L	∞		pF	
5	Rated Drive Level	P_o	0.1		mW	
6	Frequency Adjustment Tolerance	$\frac{\Delta f}{f}$	-10	+10	10^{-6}	At T_o °C
7	Resonance Resistance	R_r	-	40	Ω	At T_o °C
8	Frequency Variation with Temperature over T_{op}	$\frac{\Delta f}{f}$	-9.0	+9.0	10^{-6}	From frequency measured at T_o °C
9	Resistance Variation with Temperature over T_{op}	$\frac{\Delta R}{R}$	-10	+10	%	From resistance measured at T_o °C
10	Operating Temperature Range	T_{op}	-20	+70	°C	
11	Frequency variation with Drive Level	$\frac{\Delta f}{f}$	Not applicable		10^{-6}	
12	Resistance variation with Drive Level	$\frac{\Delta R}{R}$	Not applicable		%	
13	Motional Inductance	L_1	3.2	4.8	mH	
14	Motional Capacitance	C_1	Not applicable		fF	
15	Static Capacitance	C_o	-	7.0	pF	
16	Q Factor	Q	Not applicable		-	
17	Ratio of Unwanted: Response Resistance to Resonance Resistance or Response Impedance to Resonance Resistance	R_p/R or $ Z_p /R$	2:1	-		In the frequency range: $f_r - 50\text{kHz}$ to $f_r + 50\text{kHz}$
18	Ageing	$\frac{\Delta f}{f}$	-3.0	+3.0	10^{-6}	After burn-in, and per year
19	Terminal Length	L	Figure 2		mm	

TABLE 1(a) - TYPE VARIANT DETAILED INFORMATION

TYPE VARIANT NO. 79

No.	Characteristics	Symbol	Limits		Unit	Remarks
			Min.	Max.		
1	Resonance Frequency	f_r	65.005555		MHz	Swept
2	Reference Temperature	T_o	+23	+27	°C	
3	Overtone Order	-	3			
4	Load Capacitance	C_L	∞		pF	
5	Rated Drive Level	P_o	0.1		mW	
6	Frequency Adjustment Tolerance	$\frac{\Delta f}{f}$	-10	+10	10^{-6}	At T_o °C
7	Resonance Resistance	R_r	-	40	Ω	At T_o °C
8	Frequency Variation with Temperature over T_{op}	$\frac{\Delta f}{f}$	+9.0	-9.0	10^{-6}	From frequency measured at T_o °C
9	Resistance Variation with Temperature over T_{op}	$\frac{\Delta R}{R}$	-10	+10	%	From resistance measured at T_o °C
10	Operating Temperature Range	T_{op}	-20	+70	°C	
11	Frequency variation with Drive Level	$\frac{\Delta f}{f}$	Not applicable		10^{-6}	
12	Resistance variation with Drive Level	$\frac{\Delta R}{R}$	Not applicable		%	
13	Motional Inductance	L_1	3.2	4.8	mH	
14	Motional Capacitance	C_1	Not applicable		fF	
15	Static Capacitance	C_o	-	7.0	pF	
16	Q Factor	Q	Not applicable		-	
17	Ratio of Unwanted: Response Resistance to Resonance Resistance or Response Impedance to Resonance Resistance	R_p/R or iZ_p/R	2:1	-		In the frequency range: $f_r - 50\text{kHz}$ to $f_r + 50\text{kHz}$
18	Ageing	$\frac{\Delta f}{f}$	-3.0	+3.0	10^{-6}	After burn-in, and per year
19	Terminal Length	L	Figure 2		mm	

TABLE 1(a) - TYPE VARIANT DETAILED INFORMATION

TYPE VARIANT NO. 80

No.	Characteristics	Symbol	Limits		Unit	Remarks
			Min.	Max.		
1	Resonance Frequency	f_r	62.5		MHz	Swept
2	Reference Temperature	T_0	+23	+27	°C	
3	Overtone Order	-	3			
4	Load Capacitance	C_L	∞		pF	
5	Rated Drive Level	P_0	0.1		mW	
6	Frequency Adjustment Tolerance	$\frac{\Delta f}{f}$	-10	+10	10^{-6}	At T_0 °C
7	Resonance Resistance	R_r	-	40	Ω	At T_0 °C
8	Frequency Variation with Temperature over T_{op}	$\frac{\Delta f}{f}$	-9.0	+9.0	10^{-6}	From frequency measured at T_0 °C
9	Resistance Variation with Temperature over T_{op}	$\frac{\Delta R}{R}$	-10	+10	%	From resistance measured at T_0 °C
10	Operating Temperature Range	T_{op}	-20	+70	°C	
11	Frequency variation with Drive Level	$\frac{\Delta f}{f}$	Not applicable		10^{-6}	
12	Resistance variation with Drive Level	$\frac{\Delta R}{R}$	Not applicable		%	
13	Motional Inductance	L_1	3.2	4.8	mH	
14	Motional Capacitance	C_1	1.5 Typical		fF	
15	Static Capacitance	C_0	-	7.0	pF	
16	Q Factor	Q	Not applicable		-	
17	Ratio of Unwanted: Response Resistance to Resonance Resistance or Response Impedance to Resonance Resistance	R_p/R or $ Z_p /R$	2:1	-		In the frequency range: $f_r - 50\text{kHz}$ to $f_r + 50\text{kHz}$
18	Ageing	$\frac{\Delta f}{f}$	-3.0	+3.0	10^{-6}	After burn-in, and per year
19	Terminal Length	L	Figure 2		mm	

TABLE 1(a) - TYPE VARIANT DETAILED INFORMATION

TYPE VARIANT NO. 81

No.	Characteristics	Symbol	Limits		Unit	Remarks
			Min.	Max.		
1	Resonance Frequency	f_r	70.0		MHz	Swept
2	Reference Temperature	T_0	+23	+27	°C	
3	Overtone Order	-	3			
4	Load Capacitance	C_L	∞		pF	
5	Rated Drive Level	P_0	0.1		mW	
6	Frequency Adjustment Tolerance	$\frac{\Delta f}{f}$	-10	+10	10^{-6}	At T_0 °C
7	Resonance Resistance	R_r	-	40	Ω	At T_0 °C
8	Frequency Variation with Temperature over T_{op}	$\frac{\Delta f}{f}$	-9.0	+9.0	10^{-6}	From frequency measured at T_0 °C
9	Resistance Variation with Temperature over T_{op}	$\frac{\Delta R}{R}$	-10	+10	%	From resistance measured at T_0 °C
10	Operating Temperature Range	T_{op}	-20	+70	°C	
11	Frequency variation with Drive Level	$\frac{\Delta f}{f}$	Not applicable		10^{-6}	
12	Resistance variation with Drive Level	$\frac{\Delta R}{R}$	Not applicable		%	
13	Motional Inductance	L_1	3.2	4.8	mH	
14	Motional Capacitance	C_1	1.5 Typical		fF	
15	Static Capacitance	C_0	-	7.0	pF	
16	Q Factor	Q	Not applicable		-	
17	Ratio of Unwanted: Response Resistance to Resonance Resistance or Response Impedance to Resonance Resistance	R_p/R iZ_{pi}/R	2:1	-		In the frequency range: $f_r - 50\text{kHz}$ to $f_r + 50\text{kHz}$
18	Ageing	$\frac{\Delta f}{f}$	-3.0	+3.0	10^{-6}	After burn-in, and per year
19	Terminal Length	L	Figure 2		mm	

TABLE 1(a) - TYPE VARIANT DETAILED INFORMATION

TYPE VARIANT NO. 82

No.	Characteristics	Symbol	Limits		Unit	Remarks
			Min.	Max.		
1	Resonance Frequency	f_L	4.1379		MHz	
2	Reference Temperature	T_0	+23	+27	°C	
3	Overtone Order	-	Fundamental			
4	Load Capacitance	C_L	29.7	30.3	pF	
5	Rated Drive Level	P_0	0.1		mW	
6	Frequency Adjustment Tolerance	$\frac{\Delta f}{f}$	-10	+10	10^{-6}	At T_0 °C
7	Resonance Resistance	R_L	-	75	Ω	At T_0 °C
8	Frequency Variation with Temperature over T_{op}	$\frac{\Delta f}{f}$	-25	+25	10^{-6}	From frequency measured at T_0 °C
9	Resistance Variation with Temperature over T_{op}	$\frac{\Delta R}{R}$	-50	+50	%	From resistance measured at T_0 °C
10	Operating Temperature Range	T_{op}	-25	+75	°C	
11	Frequency variation with Drive Level	$\frac{\Delta f}{f}$	-2.0	+2.0	10^{-6}	From $P_{S1} = 20nW$ to $P_{S2} = 0.2mW$
12	Resistance variation with Drive Level	$\frac{\Delta R}{R}$	-40	+40	%	From $P_{S1} = 20nW$ to $P_{S2} = 0.2mW$
13	Motional Inductance	L_1	310	345	mH	
14	Motional Capacitance	C_1	4.39	4.87	fF	
15	Static Capacitance	C_0	1.67	2.06	pF	
16	Q Factor	Q	105 000	-	-	
17	Ratio of Unwanted: Response Resistance to Resonance Resistance or Response Impedance to Resonance Resistance	R_p/R $ Z_{pl}/R$	2:1	-		In the frequency range: $f_L - 500kHz$ to $f_L + 500kHz$
18	Ageing	$\frac{\Delta f}{f}$	-5.0	+5.0	10^{-6}	After burn-in, over 10 years
19	Terminal Length	L	Figure 2		mm	

TABLE 1(a) - TYPE VARIANT DETAILED INFORMATION

TYPE VARIANT NO. 83

No.	Characteristics	Symbol	Limits		Unit	Remarks
			Min.	Max.		
1	Resonance Frequency	f_r	65.03639		MHz	Swept
2	Reference Temperature	T_0	+23	+27	°C	
3	Overtone Order	-	3			
4	Load Capacitance	C_L	∞		pF	
5	Rated Drive Level	P_0	0.1		mW	
6	Frequency Adjustment Tolerance	$\frac{\Delta f}{f}$	-10	+10	10^{-6}	At T_0 °C
7	Resonance Resistance	R_r	-	40	Ω	At T_0 °C
8	Frequency Variation with Temperature over T_{op}	$\frac{\Delta f}{f}$	-9.0	+9.0	10^{-6}	From frequency measured at T_0 °C
9	Resistance Variation with Temperature over T_{op}	$\frac{\Delta R}{R}$	-10	+10	%	From resistance measured at T_0 °C
10	Operating Temperature Range	T_{op}	-20	+70	°C	
11	Frequency variation with Drive Level	$\frac{\Delta f}{f}$	Not applicable		10^{-6}	
12	Resistance variation with Drive Level	$\frac{\Delta R}{R}$	Not applicable		%	
13	Motional Inductance	L_1	3.2	4.8	mH	
14	Motional Capacitance	C_1	1.5 Typical		fF	
15	Static Capacitance	C_0	-	7.0	pF	
16	Q Factor	Q	Not applicable		-	
17	Ratio of Unwanted: Response Resistance to Resonance Resistance or Response Impedance to Resonance Resistance	R_p/R or iZ_p/R	2:1	-		In the frequency range: $f_r - 50\text{kHz}$ to $f_r + 50\text{kHz}$
18	Ageing	$\frac{\Delta f}{f}$	-3.0	+3.0	10^{-6}	After burn-in, and per year
19	Terminal Length	L	Figure 2		mm	

TABLE 1(a) - TYPE VARIANT DETAILED INFORMATION

TYPE VARIANT NO. 84

No.	Characteristics	Symbol	Limits		Unit	Remarks
			Min.	Max.		
1	Resonance Frequency	f_r	36.811767		MHz	
2	Reference Temperature	T_0	+25		°C	
3	Overtone Order	-	3			
4	Load Capacitance	C_L	∞		pF	
5	Rated Drive Level	P_0	0.1		mW	
6	Frequency Adjustment Tolerance	$\frac{\Delta f}{f}$	-5.0	+5.0	10^{-6}	At T_0 °C
7	Resonance Resistance	R_r	-	40	Ω	Over T_{op} °C
8	Frequency Variation with Temperature over T_{op}	$\frac{\Delta f}{f}$	+7.0	-7.0	10^{-6}	From frequency measured at T_0 °C
9	Resistance Variation with Temperature over T_{op}	$\frac{\Delta R}{R}$	Not applicable		%	
10	Operating Temperature Range	T_{op}	-25	+70	°C	
11	Frequency variation with Drive Level	$\frac{\Delta f}{f}$	Not applicable		10^{-6}	
12	Resistance variation with Drive Level	$\frac{\Delta R}{R}$	Not applicable		%	
13	Motional Inductance	L_1	Not applicable		mH	
14	Motional Capacitance	C_1	Not applicable		fF	
15	Static Capacitance	C_0	-	5.0	pF	
16	Q Factor	Q	Not applicable		-	
17	Ratio of Unwanted: Response Resistance to Resonance Resistance or Response Impedance to Resonance Resistance	R_p/R or $ Z_p /R$	3:1	-		In the frequency range: $f_r - 60\text{kHz}$ to $f_r + 60\text{kHz}$
18	Ageing	$\frac{\Delta f}{f}$	-7.0	+7.0	10^{-6}	After burn-in, over 7 years
19	Terminal Length	L	Figure 2		mm	

TABLE 1(a) - TYPE VARIANT DETAILED INFORMATION

TYPE VARIANT NO. 85

No.	Characteristics	Symbol	Limits		Unit	Remarks
			Min.	Max.		
1	Resonance Frequency	f_r	20.0		MHz	
2	Reference Temperature	T_0	+23	+27	°C	
3	Overtone Order	-	Fundamental			
4	Load Capacitance	C_L	∞		pF	
5	Rated Drive Level	P_0	0.1		mW	
6	Frequency Adjustment Tolerance	$\frac{\Delta f}{f}$	-10	+10	10^{-6}	At T_0 °C
7	Resonance Resistance	R_r	-	30	Ω	Over T_{op} °C
8	Frequency Variation with Temperature over T_{op}	$\frac{\Delta f}{f}$	-20	+20	10^{-6}	From frequency measured at T_0 °C
9	Resistance Variation with Temperature over T_{op}	$\frac{\Delta R}{R}$	-10 or -2	+10 or +2	% Ω	From resistance measured at T_0 °C
10	Operating Temperature Range	T_{op}	-30	+70	°C	
11	Frequency variation with Drive Level	$\frac{\Delta f}{f}$	Not applicable		10^{-6}	
12	Resistance variation with Drive Level	$\frac{\Delta R}{R}$	Not applicable		%	
13	Motional Inductance	L_1	Not applicable		mH	
14	Motional Capacitance	C_1	Not applicable		fF	
15	Static Capacitance	C_0	-	7.0	pF	
16	Q Factor	Q	100 000	-	-	
17	Ratio of Unwanted: Response Resistance to Resonance Resistance or Response Impedance to Resonance Resistance	R_p/R or $ Z_p /R$	2:1	-		In the frequency range: $f_r - 200\text{kHz}$ to $f_r + 200\text{kHz}$
18	Ageing	$\frac{\Delta f}{f}$	-2	+2	10^{-6}	After burn-in per year
19	Terminal Length	L	Figure 2		mm	

TABLE 1(a) - TYPE VARIANT DETAILED INFORMATION

TYPE VARIANT NO. 86

No.	Characteristics	Symbol	Limits		Unit	Remarks
			Min.	Max.		
1	Resonance Frequency	f_L	20.0		MHz	
2	Reference Temperature	T_0	+23	+27	°C	
3	Overtone Order	-	Fundamental			
4	Load Capacitance	C_L	32		pF	
5	Rated Drive Level	P_0	0.1		mW	
6	Frequency Adjustment Tolerance	$\frac{\Delta f}{f}$	-10	+10	10^{-6}	At T_0 °C
7	Resonance Resistance	R_r	-	30	Ω	At T_0 °C
8	Frequency Variation with Temperature over T_{op}	$\frac{\Delta f}{f}$	-20	+20	10^{-6}	From frequency measured at T_0 °C
9	Resistance Variation with Temperature over T_{op}	$\frac{\Delta R}{R}$	-10 or -2.0	+10 or +2.0	% Ω	From resistance measured at T_0 °C
10	Operating Temperature Range	T_{op}	-30	+70	°C	
11	Frequency variation with Drive Level	$\frac{\Delta f}{f}$	Not applicable		10^{-6}	
12	Resistance variation with Drive Level	$\frac{\Delta R}{R}$	Not applicable		%	
13	Motional Inductance	L_1	Not applicable		mH	
14	Motional Capacitance	C_1	-	7.0	fF	
15	Static Capacitance	C_0	-	7.0	pF	
16	Q Factor	Q	80 000	-	-	
17	Ratio of Unwanted: Response Resistance to Resonance Resistance or Response Impedance to Resonance Resistance	R_p/R or $ Z_p /R$	2:1	-		In the frequency range: $f_L - 200\text{kHz}$ to $f_L + 200\text{kHz}$
18	Ageing	$\frac{\Delta f}{f}$	-2.0	+2.0	10^{-6}	After burn-in and per year
19	Terminal Length	L	Figure 2		mm	

TABLE 1(a) - TYPE VARIANT DETAILED INFORMATION

TYPE VARIANT NO. 87

No.	Characteristics	Symbol	Limits		Unit	Remarks
			Min.	Max.		
1	Resonance Frequency	f_r	81.506849		MHz	PQ. Swept
2	Reference Temperature	T_0	+65	+75	°C	Turn-on Point
3	Overtone Order	-	3			
4	Load Capacitance	C_L	∞		pF	
5	Rated Drive Level	P_0	0.1		mW	
6	Frequency Adjustment Tolerance	$\frac{\Delta f}{f}$	-50	+50	10^{-6}	At T_0 °C
7	Resonance Resistance	R_r	-	40	Ω	At T_0 °C
8	Frequency Variation with Temperature over T_{op}	$\frac{\Delta f}{f}$	Not applicable		10^{-6}	
9	Resistance Variation with Temperature over T_{op}	$\frac{\Delta R}{R}$	-20	+20	%	From resistance measured at T_0 °C
10	Operating Temperature Range	T_{op}	-20	+80	°C	
11	Frequency variation with Drive Level	$\frac{\Delta f}{f}$	Not applicable		10^{-6}	
12	Resistance variation with Drive Level	$\frac{\Delta R}{R}$	Not applicable		%	
13	Motional Inductance	L_1	2.0	-	mH	
14	Motional Capacitance	C_1	Not applicable		fF	
15	Static Capacitance	C_0	-	5.0	pF	
16	Q Factor	Q	70 000		-	
17	Ratio of Unwanted: Response Resistance to Resonance Resistance or Response Impedance to Resonance Resistance	R_p/R or $ Z_p /R$	2:1	-		In the frequency range: $f_r - 8100\text{kHz}$ to $f_r + 8100\text{kHz}$
18	Ageing	$\frac{\Delta f}{f}$	-5.0	+5.0	10^{-6}	After burn-in and over 10 years
19	Terminal Length	L	Figure 2		mm	

TABLE 1(a) - TYPE VARIANT DETAILED INFORMATION

TYPE VARIANT NO. 88

No.	Characteristics	Symbol	Limits		Unit	Remarks
			Min.	Max.		
1	Resonance Frequency	f_r	121.5		MHz	
2	Reference Temperature	T_o	+23	+27	°C	
3	Overtone Order	-	5			
4	Load Capacitance	C_L	∞		pF	
5	Rated Drive Level	P_o	0.1		mW	
6	Frequency Adjustment Tolerance	$\frac{\Delta f}{f}$	-10	+10	10^{-6}	At T_o °C
7	Resonance Resistance	R_r	-	60	Ω	At T_o °C
8	Frequency Variation with Temperature over T_{op}	$\frac{\Delta f}{f}$	-20	+20	10^{-6}	From frequency measured at T_o °C
9	Resistance Variation with Temperature over T_{op}	$\frac{\Delta R}{R}$	-25	+25	%	From resistance measured at T_o °C
10	Operating Temperature Range	T_{op}	-30	+80	°C	
11	Frequency variation with Drive Level	$\frac{\Delta f}{f}$	Not applicable		10^{-6}	
12	Resistance variation with Drive Level	$\frac{\Delta R}{R}$	Not applicable		%	
13	Motional Inductance	L_1	1.44	2.16	mH	
14	Motional Capacitance	C_1	Not applicable		fF	
15	Static Capacitance	C_o	-	6.0	pF	
16	Q Factor	Q	Not applicable		-	
17	Ratio of Unwanted: Response Resistance to Resonance Resistance or Response Impedance to Resonance Resistance	R_p/R or $ Z_p /R$	2:1	-		In the frequency range: $f_r - 500\text{kHz}$ to $f_r + 500\text{kHz}$
18	Ageing	$\frac{\Delta f}{f}$	-5.0	+5.0	10^{-6}	After burn-in, over 10 years
19	Terminal Length	L	Figure 2		mm	

TABLE 1(a) - TYPE VARIANT DETAILED INFORMATION
TYPE VARIANT NO. 89

No.	Characteristics	Symbol	Limits		Unit	Remarks
			Min.	Max.		
1	Resonance Frequency	f_r	50.0		MHz	
2	Reference Temperature	T_0	+23	+27	°C	
3	Overtone Order	-	3			
4	Load Capacitance	C_L	∞		pF	
5	Rated Drive Level	P_0	0.1		mW	
6	Frequency Adjustment Tolerance	$\frac{\Delta f}{f}$	-10	+10	10^{-6}	At T_0 °C
7	Resonance Resistance	R_r	-	40	Ω	At T_0 °C
8	Frequency Variation with Temperature over T_{op}	$\frac{\Delta f}{f}$	-20	+20	10^{-6}	From frequency measured at T_0 °C
9	Resistance Variation with Temperature over T_{op}	$\frac{\Delta R}{R}$	-20	+20	%	From resistance measured at T_0 °C
10	Operating Temperature Range	T_{op}	-30	+80	°C	
11	Frequency variation with Drive Level	$\frac{\Delta f}{f}$	Not applicable		10^{-6}	
12	Resistance variation with Drive Level	$\frac{\Delta R}{R}$	Not applicable		%	
13	Motional Inductance	L_1	2.97	4.45	mH	
14	Motional Capacitance	C_1	Not applicable		fF	
15	Static Capacitance	C_0	-	6.0	pF	
16	Q Factor	Q	Not applicable		-	
17	Ratio of Unwanted: Response Resistance to Resonance Resistance or Response Impedance to Resonance Resistance	R_p/R or $ Z_p /R$	2:1	-		In the frequency range: $f_r - 500\text{kHz}$ to $f_r + 500\text{kHz}$
18	Ageing	$\frac{\Delta f}{f}$	-10	+10	10^{-6}	After burn-in, over 10 years
19	Terminal Length	L	Figure 2		mm	

TABLE 1(a) - TYPE VARIANT DETAILED INFORMATION

TYPE VARIANT NO. 90

No.	Characteristics	Symbol	Limits		Unit	Remarks
			Min.	Max.		
1	Resonance Frequency	f_r	37.75625		MHz	Swept
2	Reference Temperature	T_0	+24	+26	°C	
3	Overtone Order	-	3			
4	Load Capacitance	C_L	∞		pF	
5	Rated Drive Level	P_0	0.1		mW	
6	Frequency Adjustment Tolerance	$\frac{\Delta f}{f}$	-5.0	+5.0	10^{-6}	At T_0 °C
7	Resonance Resistance	R_r	-	40	Ω	At T_0 °C
8	Frequency Variation with Temperature over T_{op}	$\frac{\Delta f}{f}$	-9.0	+9.0	10^{-6}	From frequency measured at T_0 °C
9	Resistance Variation with Temperature over T_{op}	$\frac{\Delta R}{R}$	-10	+10	%	From resistance measured at T_0 °C
10	Operating Temperature Range	T_{op}	-20	+70	°C	
11	Frequency variation with Drive Level	$\frac{\Delta f}{f}$	Not applicable		10^{-6}	
12	Resistance variation with Drive Level	$\frac{\Delta R}{R}$	Not applicable		%	
13	Motional Inductance	L_1	15	22	mH	
14	Motional Capacitance	C_1	Not applicable		fF	
15	Static Capacitance	C_0	-	7.0	pF	
16	Q Factor	Q	90 000	-	-	
17	Ratio of Unwanted: Response Resistance to Resonance Resistance or Response Impedance to Resonance Resistance	R_p/R or $ Z_p /R$	2:1	-		In the frequency range: $f_r - 50\text{kHz}$ to $f_r + 50\text{kHz}$
18	Ageing	$\frac{\Delta f}{f}$	-3.0	+3.0	10^{-6}	After burn-in, and per year
19	Terminal Length	L	Figure 2		mm	

TABLE 1(a) - TYPE VARIANT DETAILED INFORMATION

TYPE VARIANT NO. 91

No.	Characteristics	Symbol	Limits		Unit	Remarks
			Min.	Max.		
1	Resonance Frequency	f_r	24.6827		MHz	Swept
2	Reference Temperature	T_0	+24	+26	°C	
3	Overtone Order	-	Fundamental			
4	Load Capacitance	C_L	∞		pF	
5	Rated Drive Level	P_0	0.1		mW	
6	Frequency Adjustment Tolerance	$\frac{\Delta f}{f}$	-5.0	+5.0	10^{-6}	At T_0 °C
7	Resonance Resistance	R_r	-	10	Ω	At T_0 °C
8	Frequency Variation with Temperature over T_{op}	$\frac{\Delta f}{f}$	-7.0	+7.0	10^{-6}	From frequency measured at T_0 °C
9	Resistance Variation with Temperature over T_{op}	$\frac{\Delta R}{R}$	-10 or -1.5	+10 +1.5	% Ω	From resistance measured at T_0 °C If $R < 10\Omega$
10	Operating Temperature Range	T_{op}	-20	+70	°C	
11	Frequency variation with Drive Level	$\frac{\Delta f}{f}$	Not applicable		10^{-6}	
12	Resistance variation with Drive Level	$\frac{\Delta R}{R}$	Not applicable		%	
13	Motional Inductance	L_1	Not applicable		mH	
14	Motional Capacitance	C_1	Not applicable		fF	
15	Static Capacitance	C_0	-	5.0	pF	
16	Q Factor	Q	130 000	-	-	
17	Ratio of Unwanted: Response Resistance to Resonance Resistance or Response Impedance to Resonance Resistance	R_p/R or $ Z_p /R$	2:1	-		In the frequency range: $f_r - 200\text{kHz}$ to $f_r + 200\text{kHz}$
18	Ageing	$\frac{\Delta f}{f}$	-3.0	+3.0	10^{-6}	After burn-in, and per year
19	Terminal Length	L	Figure 2		mm	

TABLE 1(a) - TYPE VARIANT DETAILED INFORMATION

TYPE VARIANT NO. 92

No.	Characteristics	Symbol	Limits		Unit	Remarks
			Min.	Max.		
1	Resonance Frequency	f_r	37.839583		MHz	Swept
2	Reference Temperature	T_0	+24	+26	°C	
3	Overtone Order	-	3			
4	Load Capacitance	C_L	∞		pF	
5	Rated Drive Level	P_0	0.1		mW	
6	Frequency Adjustment Tolerance	$\frac{\Delta f}{f}$	-5.0	+5.0	10^{-6}	At T_0 °C
7	Resonance Resistance	R_r	-	40	Ω	At T_0 °C
8	Frequency Variation with Temperature over T_{op}	$\frac{\Delta f}{f}$	+9.0	-9.0	10^{-6}	From frequency measured at T_0 °C
9	Resistance Variation with Temperature over T_{op}	$\frac{\Delta R}{R}$	-10	+10	%	From resistance measured at T_0 °C
10	Operating Temperature Range	T_{op}	-20	+70	°C	
11	Frequency variation with Drive Level	$\frac{\Delta f}{f}$	Not applicable		10^{-6}	
12	Resistance variation with Drive Level	$\frac{\Delta R}{R}$	Not applicable		%	
13	Motional Inductance	L_1	15	22	mH	
14	Motional Capacitance	C_1	Not applicable		fF	
15	Static Capacitance	C_0	-	7.0	pF	
16	Q Factor	Q	90 000	-	-	
17	Ratio of Unwanted: Response Resistance to Resonance Resistance or Response Impedance to Resonance Resistance	R_p/R or $ Z_p /R$	2:1	-		In the frequency range: $f_r - 50\text{kHz}$ to $f_r + 50\text{kHz}$
18	Ageing	$\frac{\Delta f}{f}$	-3.0	+3.0	10^{-6}	After burn-in, and per year
19	Terminal Length	L	Figure 2		mm	



TABLE 1(a) - TYPE VARIANT DETAILED INFORMATION

TYPE VARIANT NO. 93

No.	Characteristics	Symbol	Limits		Unit	Remarks
			Min.	Max.		
1	Resonance Frequency	f_r	90.875794		MHz	Swept
2	Reference Temperature	T_0	+24	+26	°C	
3	Overtone Order	-	5			
4	Load Capacitance	C_L	∞		pF	
5	Rated Drive Level	P_0	0.1		mW	
6	Frequency Adjustment Tolerance	$\frac{\Delta f}{f}$	-5.0	+5.0	10^{-6}	At T_0 °C
7	Resonance Resistance	R_r	-	45	Ω	At T_0 °C
8	Frequency Variation with Temperature over T_{op}	$\frac{\Delta f}{f}$	-9.0	+9.0	10^{-6}	From frequency measured at T_0 °C
9	Resistance Variation with Temperature over T_{op}	$\frac{\Delta R}{R}$	-20	+20	%	From resistance measured at T_0 °C
10	Operating Temperature Range	T_{op}	-20	+70	°C	
11	Frequency variation with Drive Level	$\frac{\Delta f}{f}$	Not applicable		10^{-6}	
12	Resistance variation with Drive Level	$\frac{\Delta R}{R}$	Not applicable		%	
13	Motional Inductance	L_1	6.5	-	mH	
14	Motional Capacitance	C_1	Not applicable		fF	
15	Static Capacitance	C_0	-	3.0	pF	
16	Q Factor	Q	105 000	-	-	
17	Ratio of Unwanted: Response Resistance to Resonance Resistance or Response Impedance to Resonance Resistance	R_p/R or $ Z_p /R$	2:1	-		In the frequency range: $f_r - 50\text{kHz}$ to $f_r + 50\text{kHz}$
18	Ageing	$\frac{\Delta f}{f}$	-3.0	+3.0	10^{-6}	After burn-in, and per year
19	Terminal Length	L	Figure 2		mm	

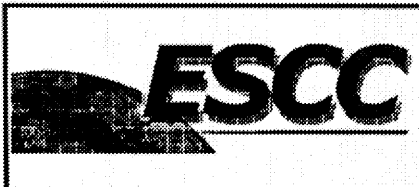

TABLE 1(a) - TYPE VARIANT DETAILED INFORMATION

TYPE VARIANT NO. 94

No.	Characteristics	Symbol	Limits		Unit	Remarks
			Min.	Max.		
1	Resonance Frequency	f_r	90.881675		MHz	Swept
2	Reference Temperature	T_0	+24	+26	°C	
3	Overtone Order	-	5			
4	Load Capacitance	C_L	∞		pF	
5	Rated Drive Level	P_0	0.1		mW	
6	Frequency Adjustment Tolerance	$\frac{\Delta f}{f}$	-5.0	+5.0	10^{-6}	At T_0 °C
7	Resonance Resistance	R_r	-	45	Ω	At T_0 °C
8	Frequency Variation with Temperature over T_{op}	$\frac{\Delta f}{f}$	-9.0	+9.0	10^{-6}	From frequency measured at T_0 °C
9	Resistance Variation with Temperature over T_{op}	$\frac{\Delta R}{R}$	-20	+20	%	From resistance measured at T_0 °C
10	Operating Temperature Range	T_{op}	-20	+70	°C	
11	Frequency variation with Drive Level	$\frac{\Delta f}{f}$	Not applicable		10^{-6}	
12	Resistance variation with Drive Level	$\frac{\Delta R}{R}$	Not applicable		%	
13	Motional Inductance	L_1	6.5	-	mH	
14	Motional Capacitance	C_1	Not applicable		fF	
15	Static Capacitance	C_0	-	3.0	pF	
16	Q Factor	Q	105 000	-	-	
17	Ratio of Unwanted: Response Resistance to Resonance Resistance or Response Impedance to Resonance Resistance	R_p/R or $ Z_p /R$	2:1	-		In the frequency range: $f_r - 50\text{kHz}$ to $f_r + 50\text{kHz}$
18	Ageing	$\frac{\Delta f}{f}$	-3.0	+3.0	10^{-6}	After burn-in, and per year
19	Terminal Length	L	Figure 2		mm	

TABLE 1(a) - TYPE VARIANT DETAILED INFORMATION

TYPE VARIANT NO. 95

No.	Characteristics	Symbol	Limits		Unit	Remarks
			Min.	Max.		
1	Resonance Frequency	f_r	90.88754		MHz	Swept
2	Reference Temperature	T_0	+24	+26	°C	
3	Overtone Order	-	5			
4	Load Capacitance	C_L	∞		pF	
5	Rated Drive Level	P_0	0.1		mW	
6	Frequency Adjustment Tolerance	$\frac{\Delta f}{f}$	-5.0	+5.0	10^{-6}	At T_0 °C
7	Resonance Resistance	R_r	-	45	Ω	At T_0 °C
8	Frequency Variation with Temperature over T_{op}	$\frac{\Delta f}{f}$	-9.0	+9.0	10^{-6}	From frequency measured at T_0 °C
9	Resistance Variation with Temperature over T_{op}	$\frac{\Delta R}{R}$	-20	+20	%	From resistance measured at T_0 °C
10	Operating Temperature Range	T_{op}	-20	+70	°C	
11	Frequency variation with Drive Level	$\frac{\Delta f}{f}$	Not applicable		10^{-6}	
12	Resistance variation with Drive Level	$\frac{\Delta R}{R}$	Not applicable		%	
13	Motional Inductance	L_1	6.5	-	mH	
14	Motional Capacitance	C_1	Not applicable		fF	
15	Static Capacitance	C_0	-	3.0	pF	
16	Q Factor	Q	105 000	-	-	
17	Ratio of Unwanted: Response Resistance to Resonance Resistance or Response Impedance to Resonance Resistance	R_p/R or $ Z_p /R$	2:1	-		In the frequency range: $f_r - 50\text{kHz}$ to $f_r + 50\text{kHz}$
18	Ageing	$\frac{\Delta f}{f}$	-3.0	+3.0	10^{-6}	After burn-in, and per year
19	Terminal Length	L	Figure 2		mm	

TABLE 1(a) - TYPE VARIANT DETAILED INFORMATION

TYPE VARIANT NO. 96

No.	Characteristics	Symbol	Limits		Unit	Remarks
			Min.	Max.		
1	Resonance Frequency	f_r	90.893413		MHz	Swept
2	Reference Temperature	T_0	+24	+26	°C	
3	Overtone Order	-	5			
4	Load Capacitance	C_L	∞		pF	
5	Rated Drive Level	P_0	0.1		mW	
6	Frequency Adjustment Tolerance	$\frac{\Delta f}{f}$	-5.0	+5.0	10^{-6}	At T_0 °C
7	Resonance Resistance	R_r	-	45	Ω	At T_0 °C
8	Frequency Variation with Temperature over T_{op}	$\frac{\Delta f}{f}$	-9.0	+9.0	10^{-6}	From frequency measured at T_0 °C
9	Resistance Variation with Temperature over T_{op}	$\frac{\Delta R}{R}$	-20	+20	%	From resistance measured at T_0 °C
10	Operating Temperature Range	T_{op}	-20	+70	°C	
11	Frequency variation with Drive Level	$\frac{\Delta f}{f}$	Not applicable		10^{-6}	
12	Resistance variation with Drive Level	$\frac{\Delta R}{R}$	Not applicable		%	
13	Motional Inductance	L_1	6.5	-	mH	
14	Motional Capacitance	C_1	Not applicable		fF	
15	Static Capacitance	C_0	-	3.0	pF	
16	Q Factor	Q	105 000	-	-	
17	Ratio of Unwanted: Response Resistance to Resonance Resistance or Response Impedance to Resonance Resistance	R_p/R or $ Z_p /R$	2:1	-		In the frequency range: $f_r - 50\text{kHz}$ to $f_r + 50\text{kHz}$
18	Ageing	$\frac{\Delta f}{f}$	-3.0	+3.0	10^{-6}	After burn-in, and per year
19	Terminal Length	L	Figure 2		mm	

TABLE 1(a) - TYPE VARIANT DETAILED INFORMATION

TYPE VARIANT NO. 97

No.	Characteristics	Symbol	Limits		Unit	Remarks
			Min.	Max.		
1	Resonance Frequency	f_r	99.53704		MHz	Swept
2	Reference Temperature	T_o	+24	+26	°C	
3	Overtone Order	-	5			
4	Load Capacitance	C_L	∞		pF	
5	Rated Drive Level	P_o	0.1		mW	
6	Frequency Adjustment Tolerance	$\frac{\Delta f}{f}$	-5.0	+5.0	10^{-6}	At T_o °C
7	Resonance Resistance	R_r	-	45	Ω	At T_o °C
8	Frequency Variation with Temperature over T_{op}	$\frac{\Delta f}{f}$	+9.0	-9.0	10^{-6}	From frequency measured at T_o °C
9	Resistance Variation with Temperature over T_{op}	$\frac{\Delta R}{R}$	-20	+20	%	From resistance measured at T_o °C
10	Operating Temperature Range	T_{op}	-20	+70	°C	
11	Frequency variation with Drive Level	$\frac{\Delta f}{f}$	Not applicable		10^{-6}	
12	Resistance variation with Drive Level	$\frac{\Delta R}{R}$	Not applicable		%	
13	Motional Inductance	L_1	4.9	-	mH	
14	Motional Capacitance	C_1	Not applicable		fF	
15	Static Capacitance	C_o	-	3.0	pF	
16	Q Factor	Q	95 000	-	-	
17	Ratio of Unwanted: Response Resistance to Resonance Resistance or Response Impedance to Resonance Resistance	R_p/R or $ Z_p /R$	2:1	-		In the frequency range: $f_r - 50\text{kHz}$ to $f_r + 50\text{kHz}$
18	Ageing	$\frac{\Delta f}{f}$	-3.0	+3.0	10^{-6}	After burn-in, and per year
19	Terminal Length	L	Figure 2		mm	



TABLE 1(a) - TYPE VARIANT DETAILED INFORMATION

TYPE VARIANT NO. 98

No.	Characteristics	Symbol	Limits		Unit	Remarks
			Min.	Max.		
1	Resonance Frequency	f_r	20.0		MHz	
2	Reference Temperature	T_0	+25		°C	
3	Overtone Order	-	Fundamental			
4	Load Capacitance	C_L	∞		pF	
5	Rated Drive Level	P_0	0.1		mW	
6	Frequency Adjustment Tolerance	$\frac{\Delta f}{f}$	-50	+50	10^{-6}	At T_0 °C
7	Resonance Resistance	R_r	-	30	Ω	Over T_{op} °C
8	Frequency Variation with Temperature over T_{op}	$\frac{\Delta f}{f}$	-50	+50	10^{-6}	From frequency measured at T_0 °C
9	Resistance Variation with Temperature over T_{op}	$\frac{\Delta R}{R}$	Not applicable		%	From resistance measured at T_0 °C
10	Operating Temperature Range	T_{op}	-55	+105	°C	
11	Frequency variation with Drive Level	$\frac{\Delta f}{f}$	Not applicable		10^{-6}	
12	Resistance variation with Drive Level	$\frac{\Delta R}{R}$	Not applicable		%	
13	Motional Inductance	L_1	Not applicable		mH	
14	Motional Capacitance	C_1	Not applicable		fF	
15	Static Capacitance	C_0	-	7.0	pF	
16	Q Factor	Q	Not applicable		-	
17	Ratio of Unwanted: Response Resistance to Resonance Resistance or Response Impedance to Resonance Resistance	R_p/R or $ Z_p /R$	7:1	-		In the frequency range: $f_r - 1.0\text{MHz}$ to $f_r + 1.0\text{MHz}$
18	Ageing	$\frac{\Delta f}{f}$	-7.5	+7.5	10^{-6}	After burn-in, per year
19	Terminal Length	L	Figure 2		mm	



TABLE 1(a) - TYPE VARIANT DETAILED INFORMATION

TYPE VARIANT NO. 99

No.	Characteristics	Symbol	Limits		Unit	Remarks
			Min.	Max.		
1	Resonance Frequency	f_L	24.5		MHz	
2	Reference Temperature	T_0	+20	+30	°C	
3	Overtone Order	-	Fundamental			
4	Load Capacitance	C_L	32		pF	
5	Rated Drive Level	P_0	0.2		mW	
6	Frequency Adjustment Tolerance	$\frac{\Delta f}{f}$	-5.0	+5.0	10^{-6}	At T_0 °C
7	Resonance Resistance	R_L	-	21	Ω	At T_0 °C
8	Frequency Variation with Temperature over T_{op}	$\frac{\Delta f}{f}$	-7.0	+7.0	10^{-6}	From frequency measured at T_0 °C
9	Resistance Variation with Temperature over T_{op}	$\frac{\Delta R}{R}$	-10 or -1.5	+10 +1.5	% Ω	From resistance measured at T_0 °C If $R < 10\Omega$
10	Operating Temperature Range	T_{op}	-20	+70	°C	
11	Frequency variation with Drive Level	$\frac{\Delta f}{f}$	Not applicable		10^{-6}	
12	Resistance variation with Drive Level	$\frac{\Delta R}{R}$	-10	+10	%	From $P_{S1} = 0.01mW$ to $P_{S2} = 0.5mW$
13	Motional Inductance	L_1	-	6.93	mH	
14	Motional Capacitance	C_1	Not applicable		fF	
15	Static Capacitance	C_0	-	3.0	pF	
16	Q Factor	Q	60 000	-	-	
17	Ratio of Unwanted: Response Resistance to Resonance Resistance or Response Impedance to Resonance Resistance	R_p/R or $ Z_{pl}/R$	3:1	-		In the frequency range: $f_L - 500kHz$ to $f_L + 500kHz$
18	Ageing	$\frac{\Delta f}{f}$	-50	+5.0	10^{-6}	After burn-in, over 10 years
19	Terminal Length	L	Figure 2		mm	

	<p>ESCC Detail Specification No. 3501/001</p>	<p>PAGE 122 ISSUE 4</p>
---	---	-----------------------------

APPENDIX 'A'

Page 1 of 1

AGREED DEVIATIONS FOR RAKON (F)

ITEMS AFFECTED	DESCRIPTION OF DEVIATION
Para. 4.2.2	Para. 9.3, Shock: Shall not be performed.
Para. 4.2.3	Para. 9.11, Radiographic Inspection: Shall not be performed.

	<p>ESCC Detail Specification No. 3501/001</p>		<p>PAGE 123 ISSUE 4</p>
--	---	--	-----------------------------

APPENDIX 'B'

Page 1 of 1

AGREED DEVIATIONS FOR KVG Quartz Crystal Technology GmbH (D)

ITEMS AFFECTED	DESCRIPTION OF DEVIATION
Para. 4.2.2 Para. 4.2.3 Para. 4.2.4 Para. 4.2.5	Para. 9.5.1, Seal Test Fine Leak: The crystal units shall be subjected to MIL-STD-202, Method 112, Procedure IIIa.