




Pages 1 to 22

**EXTRUDED, CROSS-LINKED MODIFIED ETFE  
INSULATED WIRES AND CABLES ON  
SILVER-PLATED COPPER CONDUCTOR,  
LIGHTWEIGHT, BRAIDED  
LOW FREQUENCY, 600V, - 100 TO + 200 °C  
ESCC Detail Specification No. 3901/020**

**ISSUE 3  
June 2008**



Document Custodian: European Space Agency - see <https://escies.org>

	ESCC Detail Specification No. 3901/020		PAGE i ISSUE 3
---	---	--	-------------------

### LEGAL DISCLAIMER AND COPYRIGHT

European Space Agency, Copyright © 2008. All rights reserved.

The European Space Agency disclaims any liability or responsibility, to any person or entity, with respect to any loss or damage caused, or alleged to be caused, directly or indirectly by the use and application of this ESCC publication.

This publication, without the prior permission of the European Space Agency and provided that it is not used for a commercial purpose, may be:

- copied in whole in any medium without alteration or modification.
- copied in part, in any medium, provided that the ESCC document identification, comprising the ESCC symbol, document number and document issue, is removed.



ESCC Detail Specification  
No. 3901/020

PAGE 2

ISSUE 3

**DOCUMENTATION CHANGE NOTICE**

(Refer to <https://escies.org> for ESCC DCR content)

DCR No.	CHANGE DESCRIPTION
403	Specification upissued to incorporate technical and editorial changes per DCR.



**TABLE OF CONTENTS**

	<u>Page</u>
<b>1. <u>GENERAL</u></b>	<b>5</b>
1.1 Scope	5
1.2 Type Variants	5
1.3 Maximum Ratings	5
1.4 Parameter Derating Information	5
1.5 Physical Characteristics	5
1.6 Functional Diagram	5
<b>2. <u>APPLICABLE DOCUMENTS</u></b>	<b>12</b>
<b>3. <u>TERMS, DEFINITIONS, ABBREVIATIONS, SYMBOLS AND UNITS</u></b>	<b>12</b>
<b>4. <u>REQUIREMENTS</u></b>	<b>12</b>
4.1 General	12
4.2 Deviations from Generic Specification	12
4.2.1 Deviations from Special In-process Controls	12
4.2.2 Deviations from Final Production Tests	12
4.2.3 Deviations from Burn-in and Electrical Measurements	12
4.2.4 Deviations from Qualification, Environmental and Endurance Tests	12
4.2.5 Deviations from Lot Acceptance Tests	12
4.3 Mechanical Requirements	13
4.3.1 Dimension Check	13
4.3.2 Weight	13
4.4 Materials and Finishes	14
4.4.1 Conductor	14
4.4.2 Insulation	14
4.4.3 Assembly	15
4.4.4 Shield	15
4.4.5 Jacket	16
4.5 Marking	16
4.5.1 General	16
4.5.2 The ESCC Component Number	16
4.5.3 Characteristics	16
4.5.4 Traceability Information	17
4.5.5 Additional Marking	17
4.6 Electrical Measurements	17
4.6.1 Electrical Measurements at Room Temperature	17
4.6.2 Electrical Measurements at High and Low Temperatures	17
4.6.3 Circuits for Electrical Measurements	17
4.7 Burn-in Tests	17
4.8 Environmental and Endurance Tests	18
4.8.1 Mechanical Properties of Conductor	18
4.8.2 Accelerated Ageing	18
4.8.3 Wrap Test at Ambient Temperature	18
4.8.4 Voltage Test	18
4.8.5 Shrinkage	18
4.8.6 Blocking	18
4.8.7 Cold Bend Test	18
4.8.8 Cut-through Resistance	20
4.8.9 Notch Resistance	20



	<u>Page</u>
4.8.10 Flammability	20
4.8.11 Resistance to Fluids	20
4.8.12 Surface Resistance	20
4.8.13 Abrasion Resistance	20
4.8.14 Soldering	21
4.8.15 Solderability	21
4.8.16 Radiation Resistance	21
4.8.17 Overload Resistance	21
4.8.18 Long-term Ageing Test	21
4.8.19 Anthony and Brown Test	21

### TABLES


1(a) Type Variants	6
1(b) Maximum Ratings	10
A Mandrel Diameters and Loads for Finished Wires	17
B Mandrel Diameters and Loads for Shielded and Jacketed Cables	19
C Mandrel Diameters and Loads for Finished Wires or Cores	20
2 Electrical Measurements at Room Temperature	21

### FIGURES

1 Parameter Derating Information	10
2 Physical Characteristics	11

### APPENDICES (Applicable to specific Manufacturers only)

'A' Agreed Deviations for Tyco Electronics (UK) LTD. (GB)	22
---	----

	<p style="text-align: center;">ESCC Detail Specification No. 3901/020</p>	<p>PAGE 5 ISSUE 3</p>
---	---	---------------------------

**1. GENERAL**

**1.1 SCOPE**

This specification details the ratings, physical and electrical characteristics, test and inspection data for Extruded Cross-linked Modified ETFE Insulated Wires and Cables, Lightweight, Braided, Low Frequency, 600V, -100 to +200 °C.

It shall be read in conjunction with ESCC Generic Specification No. 3901, the requirements of which are supplemented herein.

**1.2 TYPE VARIANTS**

Variants of the basic types of wires and cables specified herein which are also covered by this specification, are listed in Table 1(a).

**1.3 MAXIMUM RATINGS**

The maximum ratings, applicable to the finished wires and cables specified herein, which shall not be exceeded at any time during use or storage in controlled space environment, are scheduled in Table 1(b).

**1.4 PARAMETER DERATING INFORMATION**

The derating information applicable to the finished wires and cables specified herein is as follows:

- The maximum current for each wire used in a bundle shall be:-

$$I_{Bmax} = I_{max} \times \frac{29 - n}{28} \quad (\text{for } 1 < n < 15)$$

$$I_{Bmax} = \frac{I_{max}}{2} \quad (\text{for } n > 15)$$

where n = number of wires in the bundle;

- The temperature derating information is shown in Figure 1 with maximum current  $I_{max}$  for a single wire.
- The derating factors contained herein indicate maximum stress values and do not preclude further derating.

**1.5 PHYSICAL CHARACTERISTICS**

The physical characteristics of the finished wires and cables specified herein are shown in Figure 2.

**1.6 FUNCTIONAL DIAGRAM**

Not applicable.

**TABLE 1(a) - TYPE VARIANTS**

VARIANT No.	SHIELDED	UN-SHIELDED	No. OF CORES	WIRE SIZE ISO/ (AWG)	STRANDING No. OF STRANDS x DIAMETER (mm)	CONDUCTOR CHARACTERISTICS			SHIELD STRAND Ø (mm)	CORE MAX Ø (mm)	FINISHED WIRE OR CABLE CHARACTERISTICS	
						MAX Ø (mm)	NOM SECT. (mm <sup>2</sup> )	MAX OHMIC RESISTANCE (Ω/km)			MAX Ø (mm)	MAX WEIGHT (kg/km)
01		X	1	- / (30)	7 x 0.10 (2)	0.31	0.06	410	-	-	0.56	0.82
02		X	1	- / (28)	7 x 0.12 (2)	0.38	0.08	248.9	-	-	0.63	1.15
03		X	1	001/(26)	19 x 0.10 (1) (2)	0.50	0.15	150	-	-	0.75	1.81
04		X	1	002/(24)	19 x 0.12 (1) (2)	0.62	0.21	106	-	-	0.87	2.50
05		X	1	004/(22)	19 x 0.15 (1)	0.76	0.34	58	-	-	1.01	3.78
06		X	1	006/(20)	19 x 0.20 (1)	1.01	0.60	32.3	-	-	1.26	6.31
07		X	1	010	19 x 0.25 (1)	1.26	0.93	20.3	-	-	1.56	9.72
08		X	1	012/(16)	19 x 0.30 (1)	1.55	1.20	14.8	-	-	1.90	14.05
09		X	1	020	37 x 0.25 (1)	1.82	2.00	10.2	-	-	2.29	19.44
10		X	1	030/(12)	37 x 0.32 (1)	2.28	3.00	6.51	-	-	2.74	29.92
11		X	2	- / (30)	7 x 0.10 (2)	0.31	0.06	423	-	0.56	1.12	1.65
12		X	2	- / (28)	7 x 0.12 (2)	0.38	0.08	256.4	-	0.63	1.26	2.35
13		X	2	001/(26)	19 x 0.10 (1) (2)	0.50	0.15	154.5	-	0.75	1.50	3.73
14		X	2	002/(24)	19 x 0.12 (1) (2)	0.62	0.21	109.2	-	0.87	1.74	5.15
15		X	2	004/(22)	19 x 0.15 (1)	0.76	0.34	59.8	-	1.01	2.02	7.79
16		X	2	006/(20)	19 x 0.20 (1)	1.01	0.60	33.3	-	1.26	2.52	13.00
17		X	2	010	19 x 0.25 (1)	1.26	0.93	20.9	-	1.56	3.12	20.02
18		X	2	012/(16)	19 x 0.30 (1)	1.55	1.20	15.2	-	1.90	3.79	28.31
19		X	2	020	37 x 0.25 (1)	1.82	2.00	10.5	-	2.29	4.58	39.16
20		X	2	030/(12)	37 x 0.32 (1)	2.28	3.00	6.7	-	2.74	5.48	60.58

**NOTES**  
1. In accordance with ISO 2635. AWG sizes are given for reference.  
2. Copper alloy.



ESCC Detail Specification  
No. 3901/020

PAGE 7

ISSUE 3

**TABLE 1(a) - TYPE VARIANTS (CONTINUED)**

VARIANT No.	SHIELDED	UN-SHIELDED	No. OF CORES	WIRE SIZE ISO/ (AWG)	STRANDING No. OF STRANDS x DIAMETER (mm)	CONDUCTOR CHARACTERISTICS			SHIELD STRAND Ø (mm)	CORE MAX Ø (mm)	FINISHED WIRE OR CABLE CHARACTERISTICS	
						MAX Ø (mm)	NOM SECT. (mm <sup>2</sup> )	MAX OHMIC RESISTANCE (Ω/km)			MAX Ø (mm)	MAX WEIGHT (kg/km)
21		X	3	- / (30)	7 x 0.10 (2)	0.31	0.06	423	-	0.56	1.21	2.47
22		X	3	- / (28)	7 x 0.12 (2)	0.38	0.08	256.4	-	0.63	1.36	3.52
23		X	3	001/(26)	19 x 0.10 (1) (2)	0.50	0.15	154.5	-	0.75	1.62	5.59
24		X	3	002/(24)	19 x 0.12 (1) (2)	0.62	0.21	109.2	-	0.87	1.88	7.73
25		X	3	004/(22)	19 x 0.15 (1)	0.76	0.34	59.8	-	1.01	2.18	11.68
26		X	3	006/(20)	19 x 0.20 (1)	1.01	0.60	33.3	-	1.26	2.72	19.50
27		X	3	010	19 x 0.25 (1)	1.26	0.93	20.9	-	1.56	3.37	30.03
28		X	3	012/(16)	19 x 0.30 (1)	1.55	1.20	15.2	-	1.90	4.10	42.51
29		X	3	020	37 x 0.25 (1)	1.82	2.00	10.5	-	2.29	4.95	58.80
30		X	3	030/(12)	37 x 0.32 (1)	2.28	3.00	6.7	-	2.74	5.92	90.88
31		X	4	- / (30)	7 x 0.10 (2)	0.31	0.06	423	-	0.56	1.35	3.30
32		X	4	- / (28)	7 x 0.12 (2)	0.38	0.08	256.4	-	0.63	1.52	4.70
33		X	4	001/(26)	19 x 0.10 (1) (2)	0.50	0.15	154.5	-	0.75	1.81	7.46
34		X	4	002/(24)	19 x 0.12 (1) (2)	0.62	0.21	109.2	-	0.87	2.10	10.30
35		X	4	004/(22)	19 x 0.15 (1)	0.76	0.34	59.8	-	1.01	2.43	15.57
36		X	4	006/(20)	19 x 0.20 (1)	1.01	0.60	33.3	-	1.26	3.04	26.00
37		X	4	010	19 x 0.25 (1)	1.26	0.93	20.9	-	1.56	3.76	40.05
38		X	4	012/(16)	19 x 0.30 (1)	1.55	1.20	15.2	-	1.90	4.57	56.77
39		X	4	020	37 x 0.25 (1)	1.82	2.00	10.5	-	2.29	5.52	78.53
40		X	4	030/(12)	37 x 0.32 (1)	2.28	3.00	6.7	-	2.74	6.60	121.17

**NOTES**  
1. In accordance with ISO 2635. AWG sizes are given for reference.  
2. Copper alloy.





ESCC Detail Specification  
No. 3901/020

**TABLE 1(a) - TYPE VARIANTS (CONTINUED)**

VARIANT No.	SHIELDED	UN-SHIELDED	No. OF CORES	WIRE SIZE ISO/(AWG)	STRANDING No. OF STRANDS x DIAMETER (mm)	CONDUCTOR CHARACTERISTICS			SHIELD STRAND Ø (mm)	CORE MAX Ø (mm)	FINISHED WIRE OR CABLE CHARACTERISTICS	
						MAX Ø (mm)	NOM SECT. (mm <sup>2</sup> )	MAX OHMIC RESISTANCE (Ω/km)			MAX Ø (mm)	MAX WEIGHT (kg/km)
41	X		1	- / (30)	7 x 0.10 (2)	0.31	0.06	410	0.10	0.56	1.39	4.18
42	X		1	- / (28)	7 x 0.12 (2)	0.38	0.08	248.9	0.10	0.63	1.45	4.78
43	X		1	001/(26)	19 x 0.10 (1) (2)	0.50	0.15	150	0.10	0.75	1.57	5.91
44	X		1	002/(24)	19 x 0.12 (1) (2)	0.62	0.21	106	0.10	0.87	1.69	7.06
45	X		1	004/(22)	19 x 0.15 (1)	0.76	0.34	58	0.10	1.01	1.87	9.09
46	X		1	006/(20)	19 x 0.20 (1)	1.01	0.60	32.3	0.10	1.26	2.12	12.57
47	X		1	010	19 x 0.25 (1)	1.26	0.93	20.3	0.10	1.56	2.41	17.10
48	X		1	012/(16)	19 x 0.30 (1)	1.55	1.20	15.2	0.10	1.90	2.78	23.25
49	X		1	020	37 x 0.25 (1)	1.82	2.00	10.5	0.10	2.29	3.17	30.22
50	X		1	030/(12)	37 x 0.32 (1)	2.28	3.00	6.7	0.10	2.74	3.65	42.52
51	X		2	- / (30)	7 x 0.10 (2)	0.31	0.06	423	0.10	0.56	1.92	6.61
52	X		2	- / (28)	7 x 0.12 (2)	0.38	0.08	256.4	0.10	0.63	2.06	7.71
53	X		2	001/(26)	19 x 0.10 (1) (2)	0.50	0.15	154.5	0.10	0.75	2.31	9.86
54	X		2	002/(24)	19 x 0.12 (1) (2)	0.62	0.21	109.2	0.10	0.87	2.55	11.97
55	X		2	004/(22)	19 x 0.15 (1)	0.76	0.34	59.8	0.10	1.01	2.85	15.64
56	X		2	006/(20)	19 x 0.20 (1)	1.01	0.60	33.3	0.10	1.26	3.35	22.39
57	X		2	010	19 x 0.25 (1)	1.26	0.93	20.9	0.10	1.56	3.92	31.19
58	X		2	012/(16)	19 x 0.30 (1)	1.55	1.20	15.2	0.10	1.90	4.61	42.39
59	X		2	020	37 x 0.25 (1)	1.82	2.00	10.5	0.10	2.29	5.46	56.25
60	X		2	030/(12)	37 x 0.32 (1)	2.28	3.00	6.7	0.10	2.74	6.43	81.04

**NOTES** 1. In accordance with ISO 2635. AWG sizes are given for reference.

2. Copper alloy.



ESCC Detail Specification  
No. 3901/020

**TABLE 1(a) - TYPE VARIANTS (CONTINUED)**

VARIANT No.	SHIELDED	UN-SHIELDED	No. OF CORES	WIRE SIZE ISO/(AWG)	STRANDING No. OF STRANDS x DIAMETER (mm)	CONDUCTOR CHARACTERISTICS			SHIELD STRAND Ø (mm)	CORE MAX Ø (mm)	FINISHED WIRE OR CABLE CHARACTERISTICS	
						MAX Ø (mm)	NOM SECT. (mm <sup>2</sup> )	MAX OHMIC RESISTANCE (Ω/km)			MAX Ø (mm)	MAX WEIGHT (kg/km)
61	X		3	- /30	7 x 0.10 (2)	0.31	0.06	423	0.10	0.56	2.01	8.35
62	X		3	- /28	7 x 0.12 (2)	0.38	0.08	256.4	0.10	0.63	2.16	10.10
63	X		3	001/(26)	19 x 0.10 (1) (2)	0.50	0.15	154.5	0.10	0.75	2.43	13.15
64	X		3	002/(24)	19 x 0.12 (1) (2)	0.62	0.21	109.2	0.10	0.87	2.69	16.25
65	X		3	004/(22)	19 x 0.15 (1)	0.76	0.34	59.8	0.10	1.01	3.00	21.22
66	X		3	006/(20)	19 x 0.20 (1)	1.01	0.60	33.3	0.10	1.26	3.55	31.11
67	X		3	010	19 x 0.25 (1)	1.26	0.93	20.9	0.10	1.56	4.16	43.86
68	X		3	012/(16)	19 x 0.30 (1)	1.55	1.20	15.2	0.10	1.90	4.91	59.14
69	X		3	020	37 x 0.25 (1)	1.82	2.00	10.5	0.10	2.29	5.83	78.34
70	X		3	030/(12)	37 x 0.32 (1)	2.28	3.00	6.7	0.10	2.74	6.87	114.39
71	X		4	- /30	7 x 0.10 (2)	0.31	0.06	423	0.10	0.56	2.14	10.03
72	X		4	- /28	7 x 0.12 (2)	0.38	0.08	256.4	0.10	0.63	2.32	12.26
73	X		4	001/(26)	19 x 0.10 (1) (2)	0.50	0.15	154.5	0.10	0.75	2.61	16.15
74	X		4	002/(24)	19 x 0.12 (1) (2)	0.62	0.21	109.2	0.10	0.87	2.91	20.13
75	X		4	004/(22)	19 x 0.15 (1)	0.76	0.34	59.8	0.10	1.01	3.25	26.56
76	X		4	006/(20)	19 x 0.20 (1)	1.01	0.60	33.3	0.10	1.26	3.87	39.41
77	X		4	010	19 x 0.25 (1)	1.26	0.93	20.9	0.10	1.56	4.55	56.04
78	X		4	012/(16)	19 x 0.30 (1)	1.55	1.20	15.2	0.10	1.90	5.37	75.97
79	X		4	020	37 x 0.25 (1)	1.82	2.00	10.5	0.10	2.29	6.40	101.09
80	X		4	030/(12)	37 x 0.32 (1)	2.28	3.00	6.7	0.10	2.74	7.56	147.27

**NOTES**  
1. In accordance with ISO 2635. AWG sizes are given for reference.  
2. Copper alloy.

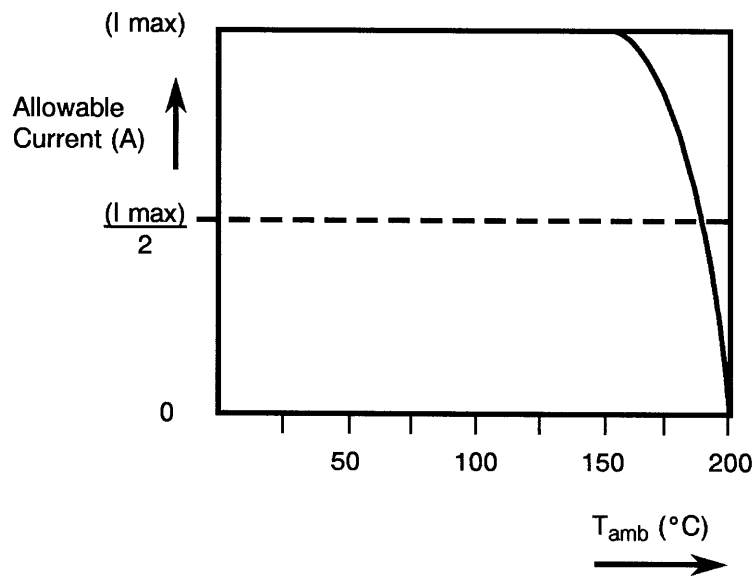
**TABLE 1(b) - MAXIMUM RATINGS**

No.	CHARACTERISTICS	SYMBOL	MAXIMUM RATINGS	UNIT	REMARKS
1	Voltage	$V_p$	600	$V_{rms}$	
2	Maximum Current (Note 1)	$I_{max}$		A	Nom. Sect. (mm <sup>2</sup> )
			1.5	0.06	30
			2.0	0.08	28
			2.5	0.15	26
			3.5	0.21	24
			5.0	0.34	22
			7.5	0.60	20
			10.0	0.93	-
			13.0	1.20	16
			17.0	2.00	-
	23.0	3.00	12		
3	Operating Temperature Range	$T_{amb}$	- 100 to + 200	°C	
4	Storage Temperature Range	$T_{stg}$	- 100 to + 200	°C	

**NOTES**

- The above specified current will generate a temperature rise of approximately 50°C above ambient temperature in a vacuum environment. Precautions shall be taken to prevent the total temperature of the wire (ambient plus rise) exceeding the continuous operating temperature of the wire.

**FIGURE 1 - PARAMETER DERATING INFORMATION**

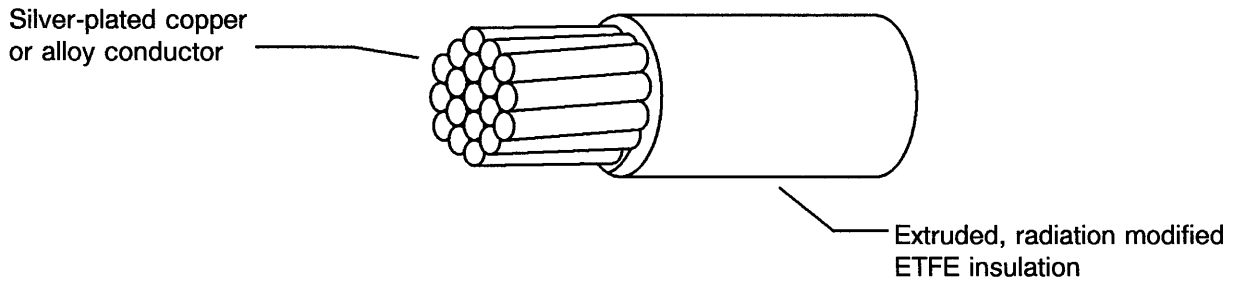


Allowable Current versus Temperature

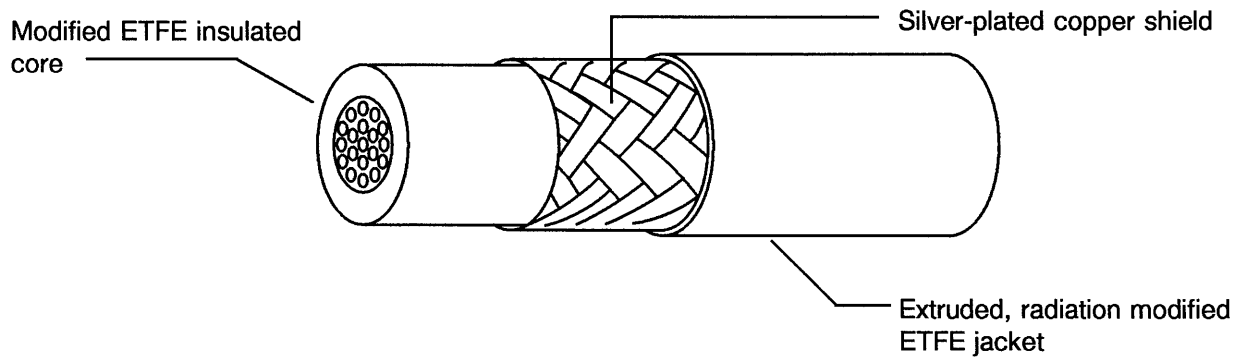
**FIGURE 2 - PHYSICAL CHARACTERISTICS**

Dimensions are given in Table 1(a)

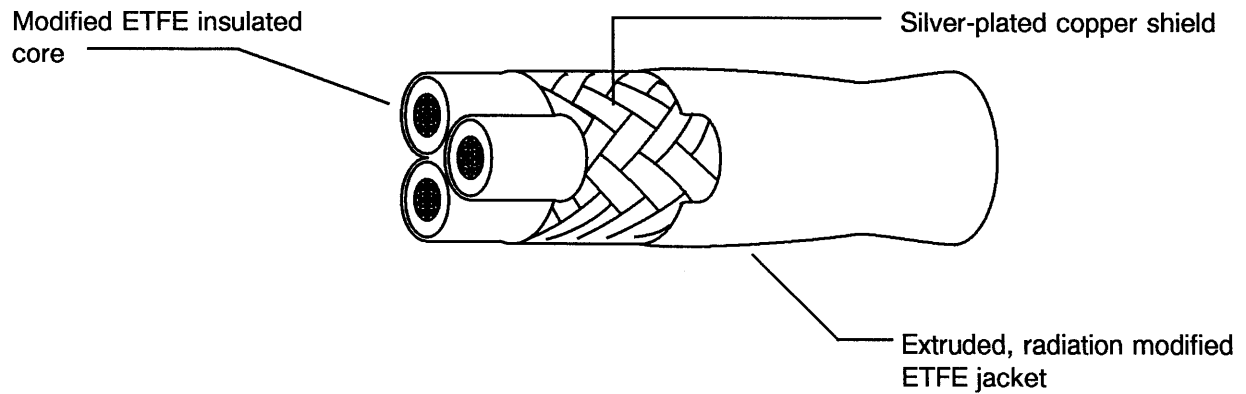
**FIGURE 2(a) - FINISHED WIRES**

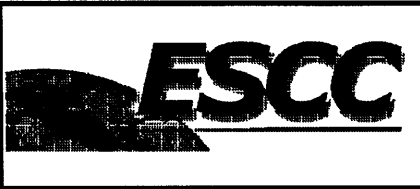


**FIGURE 2(b) - SHIELDED AND JACKETED CABLES**



**FIGURE 2(c) - SHIELDED AND JACKETED CABLES**





## 2. APPLICABLE DOCUMENTS

The following documents form part of this specification and shall be read in conjunction with it:-

- (a) ESCC Generic Specification No. 3901, Wires and Cables, Electrical, 600V, Low Frequency.
- (b) ASTM-B298-74, Silver-coated Soft or Annealed Copper Wires.
- (c) MIL-F-14256, Flux, Soldering, Liquid (Rosin Base).
- (d) ISO 2635, Conductors for General Purpose Aircraft Electrical Cables and Aerospace Applications - Dimensions and Characteristics.

## 3. TERMS, DEFINITIONS, ABBREVIATIONS, SYMBOLS AND UNITS

For the purpose of this specification, the terms, definitions, abbreviations, symbols and units specified in ESCC Basic Specification No. 21300 and ESCC Generic Specification No. 3901 shall apply.

## 4. REQUIREMENTS

### 4.1 GENERAL

The complete requirements for procurement of the finished wires and cables specified herein are stated in this specification and ESCC Generic Specification No. 3901. Deviations from the Generic Specification, applicable to this specification only, are listed in Para 4.2.

Deviations from the applicable Generic Specification and this Detail Specification, formally agreed with specific Manufacturers on the basis that the alternative requirements are equivalent to the ESCC requirements and do not affect the components' reliability, are listed in the Appendices attached to this specification.

### 4.2 DEVIATIONS FROM GENERIC SPECIFICATION

#### 4.2.1 Deviations from Special In-process Controls

None.

#### 4.2.2 Deviations from Final Production Tests (Chart II)

None.

#### 4.2.3 Deviations from Burn-in and Electrical Measurements (Chart III)

Not applicable.

#### 4.2.4 Deviations from Qualification, Environmental and Endurance Tests (Chart IV)

None.

#### 4.2.5 Deviations from Lot Acceptance Tests (Chart V)

None.

4.3 MECHANICAL REQUIREMENTS

4.3.1 Dimension Check

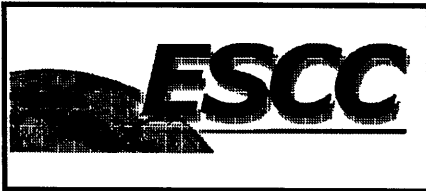
The dimensions of the finished wires and cables specified herein shall be checked; they shall conform to those shown in Table 1(a), Figure 2 and Para 4.4 of this specification (see below for the list of parameters to be checked).

**LIST OF PARAMETERS TO BE CHECKED**

PARAMETER	TABLE 1(a)	FIGURE 2	PARA 4.4
<u>COMPOSITION</u>			
Number of conductors	X		
Gauge	X		
Shielding	X		
Jacket		X	
<u>CONDUCTOR</u>			
Nature			X
Outer diameter	X		
Number of strands	X		
Strand diameter	X		
Length of lay			X
Silver thickness			X
<u>INSULATION</u>			
Composition		X	X
Thickness			X
Concentricity			X
Outer diameter	X		
Core identification			X
Colour			X
<u>SHIELDING</u>			
Number of strands	X		
Type of shielding			X
Strand diameter	X		
Shield strand adhesion			X
Shielding lay			X
Shield coverage			X
<u>JACKET</u>			
Composition		X	X
Thickness			X
Concentricity			X
Outer diameter	X		
Colour			X

4.3.2 Weight

The maximum weight of the finished wires and cables specified herein shall be as specified in Table 1(a).

	<p style="text-align: center;">ESCC Detail Specification No. 3901/020</p>	<p style="text-align: right;">PAGE 14 ISSUE 3</p>
--	---	---

#### 4.4 MATERIALS AND FINISHES

The materials and finishes shall be as specified herein. Where a definite material is not specified, a material which will enable the wires and cables specified herein to meet the performance requirements of this specification shall be used. Acceptance or approval of any constituent material does not guarantee acceptance of the finished product.

##### 4.4.1 Conductor

###### 4.4.1.1 Material Characteristics

All strands used in the manufacture of the conductors shall be silver-plated, high strength copper alloy for sizes 0.06 to 0.21mm<sup>2</sup> inclusive and silver-plated, soft or annealed, high conductivity copper for sizes 0.34 to 3.00mm<sup>2</sup> inclusive. The silver-coating on all strands shall be 2.0µm minimum.

On all copper conductors, any strand shall show a 10% minimum elongation at break and a 220N/mm<sup>2</sup> minimum tensile strength. On all high-strength alloy conductors, any strand shall show a 6% minimum elongation at break and a 350N/mm<sup>2</sup> minimum tensile strength.

The test shall be performed on single strands from the complete conductor, except for copper alloy, where the inner 7 strands shall be tested together to eliminate variance.

For determination of the conductor resistance at +20°C as mentioned in Para. 9.5 of ESCC Generic Specification No. 3901, the 'α' coefficient for copper alloy is 0.0035.

###### 4.4.1.2 Stranding

The conductors shall be constructed of concentrically laid strands to produce a smooth and uniform conductor of circular cross-section and free from any high strands or other surface irregularities.

The length of the lay of the external layer shall not be less than 8, nor more than 16, times the maximum conductor diameter specified in Table 1(a).

###### 4.4.1.3 Silver-Coating Characteristics

###### (a) Continuity

The silver-coating of the conductor strands shall be continuous. It shall not exhibit visible black spots after testing in accordance with the methods outlined in ASTM-B298-74. The test shall be performed on 3 specimens taken before applying the insulation.

###### (b) Adhesion

The silver-coating shall adhere firmly to the surface of the copper and not exhibit visible detachment when tested in accordance with ASTM-B298-74. This test shall be performed on 3 specimens taken before application of the insulation.

##### 4.4.2 Insulation

###### 4.4.2.1 Material

The insulating material shall be a flame-retarded radiation cross-linked ethylene-tetrafluoroethylene copolymer with additives necessary for processing, performance and colour identification.

	<p style="text-align: center;">ESCC Detail Specification No. 3901/020</p>	<p style="text-align: right;">PAGE 15 ISSUE 3</p>
--	---	---

#### 4.4.2.2 Construction

The wire insulation shall consist of a single wall extrusion of polymer directly onto the conductor and of a 0.08 to 0.165mm wall thickness depending upon the conductor size detailed in Table 1(a). The insulation shall have an even wall thickness and shall be concentric with the conductor, having a concentricity value (% ratio of minimum to maximum wall thickness) of 70% minimum.

#### 4.4.2.3 Insulation colour

The insulation shall be extruded in a range of 11 colours as identified in Para. 4.5.3.

#### 4.4.3 Assembly

##### 4.4.3.1 Construction

A multicore cable shall be constructed by assembling the cores in a concentric lay. The length of lay shall not be less than 10, nor more than 16, times the maximum multicore assembly diameter as detailed in Table 1(a).

#### 4.4.4 Shield

##### 4.4.4.1 Material

The shield shall be constructed from silver-coated, soft or annealed high-conductivity copper. Any strand shall show a 10% minimum elongation at break.

##### 4.4.4.2 Construction

The shield shall be made of closely woven round strands and provide not less than 85% coverage, 'K' being calculated by the following formula:-

$$K = (2F - F^2) 100,$$

where:-

$$K = \% \text{ coverage,}$$

$$F = \frac{n \cdot d \cdot P}{\sin a}$$

where:-

n = number of strands per carrier,

d = strand diameter,

P = picks per millimetre,

a = angle of braid in relation to cable axis,

$$\tan a = \frac{2\pi (D + 2d) P}{C}$$

where:-

D = diameter of cable under shield,

C = number of carriers.

##### 4.4.4.3 Silver-Coating Characteristics

The silver-coating characteristics of the shield wires shall conform to those of the conductor as specified in Para. 4.4.1.3.



4.4.5 Jacket

The jacket material shall be an extruded flame-retarded radiation cross-linked ethylene-tetrafluoroethylene copolymer with additives necessary for processing, performance and colour identification.

The jacket shall have an even wall thickness of 0.125mm minimum. The jacket shall be extruded in a range of 11 colours as identified in Para. 4.5.3.

4.5 MARKING

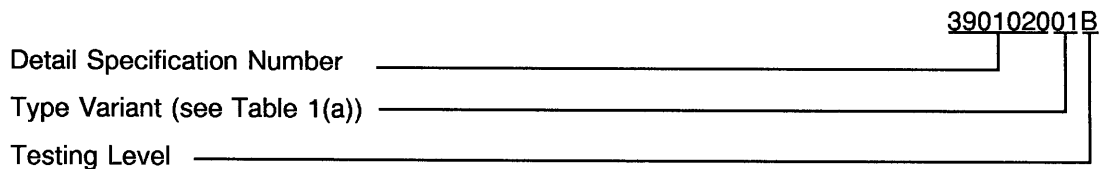
4.5.1 General

The marking of all spools of finished wires and cables delivered to this specification shall be in accordance with the requirements of ESCC Basic Specification No. 21700. Each spool shall be marked in respect of:-

- (a) The ESCC Component Number.
- (b) Characteristics.
- (c) Traceability Information.
- (d) Additional Marking.

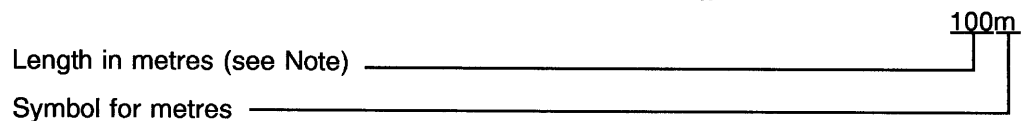
4.5.2 The ESCC Component Number

Each spool shall bear the ESCC Component Number which shall be constituted and marked as follows:-



4.5.3 Characteristics

The characteristics shall show the length(s) of finished wire or cable wound on each spool and the colours used for conductor insulation and jacket. The length shall be marked as follows:-

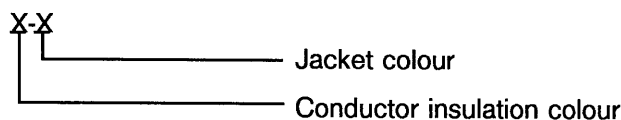


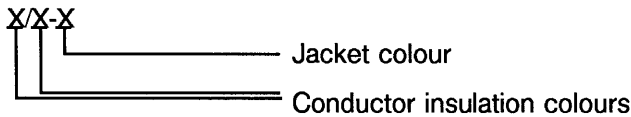
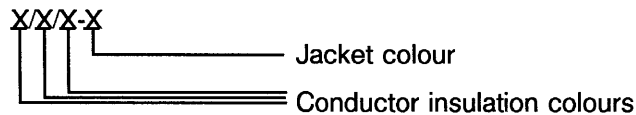
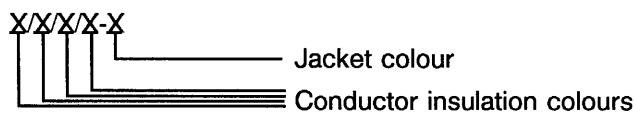
**NOTES**

1. Whenever the length is less than 100 metres, insert a zero in the first block (example: 075m). If more than one length of finished wire or cable is wound on a spool, the characteristics of each length shall be marked as above.

The colours used for conductor insulation and jacket shall be marked as follows:

Single Conductor (Variants 01 to 10 and 41 to 50)



Two Conductors (Variants 11 to 20 and 51 to 60)Three Conductors (Variants 21 to 30 and 61 to 70)Four Conductors (Variants 31 to 40 and 71 to 80)

The following codes shall be used for Conductor Insulation and Jacket colours:

0 = Black	4 = Yellow	8 = Grey
1 = Brown	5 = Green	9 = White
2 = Red	6 = Blue	2L = Pink
3 = Orange	7 = Violet	

For example, the marking "0/2-9" indicates that one conductor is black, the other is red, and the jacket is white.

If no colour coding is specified, the wires and cables shall be delivered with white conductor insulation and jackets.

#### 4.5.4 Traceability Information

Each spool shall be marked in respect of traceability information in accordance with the requirements of ESCC Basic Specification No. 21700.

#### 4.5.5 Additional Marking

Each spool shall bear the cable Manufacturer's Quality Control Inspector's stamp or initials.

### 4.6 ELECTRICAL MEASUREMENTS

#### 4.6.1 Electrical Measurements at Room Temperature

The parameters to be measured at room temperature are scheduled in Table 2. The measurements shall be performed at  $T_{amb} = +22 \pm 3$  °C.

#### 4.6.2 Electrical Measurements at High and Low Temperatures

Not applicable.

#### 4.6.3 Circuits for Electrical Measurements

Not applicable.

### 4.7 BURN-IN TESTS

Not applicable.



4.8 ENVIRONMENTAL AND ENDURANCE TESTS

4.8.1 Mechanical Properties of Conductor

As detailed in Paras. 4.4.1.1, 4.4.4 and 4.4.5 of this specification.

4.8.2 Accelerated Ageing

Ageing Temperature  $+230 \pm 5$  °C.

The mandrel diameter and appropriate weight used for accelerated age testing of the finished wires are given in Table A. For shielded cables, a change in this shield's aspect shall not be cause for rejection.

**TABLE A - MANDREL DIAMETERS AND LOADS FOR FINISHED WIRES**

Wire Size (mm <sup>2</sup> )	Mandrel Diameter (mm)	Weight (kg)
0.06	6.5	0.060
0.08	6.5	0.060
0.15	10.0	0.060
0.21	10.0	0.115
0.34	13.0	0.170
0.60	13.0	0.230
0.93	13.0	0.230
1.20	20.0	0.340
2.00	25.0	0.450
3.00	38.0	0.680

4.8.3 Wrap Test at Ambient Temperature

The mandrel diameters and applied loads for wrap testing of finished wires are given in Table A. The mandrel diameters and applied loads for screened and jacketed cables are given in Table B.

4.8.4 Voltage Test

No particular conditions are applicable.

4.8.5 Shrinkage

The shrinkage temperature shall be  $+200 \pm 5$  °C

4.8.6 Blocking

The blocking temperature shall be  $+200 \pm 5$  °C.

4.8.7 Cold Bend Test

The mandrel diameters and loads shall be as specified in Table C.

**TABLE B - MANDREL DIAMETERS AND LOADS FOR SHIELDED  
AND JACKETED CABLES**

CABLE SIZE (mm <sup>2</sup> )	NUMBER OF CORES	MANDREL DIAMETER (mm)	LOAD (kg)
0.06	1	19	0.06
	2	19	0.12
	3	19	0.18
	4	25	0.24
0.08	1	19	0.06
	2	25	0.12
	3	25	0.18
	4	25	0.24
0.15	1	19	0.06
	2	25	0.12
	3	25	0.18
	4	32	0.24
0.21	1	19	0.12
	2	25	0.23
	3	25	0.35
	4	32	0.40
0.34	1	19	0.17
	2	32	0.34
	3	32	0.51
	4	44	0.68
0.60	1	25	0.23
	2	32	0.46
	3	44	0.69
	4	44	0.92
0.93	1	25	0.23
	2	44	0.46
	3	44	0.69
	4	57	0.92
1.20	1	25	0.34
	2	44	0.68
	3	44	1.02
	4	57	1.36
2.00	1	32	0.45
	2	57	0.68
	3	57	1.35
	4	57	1.80
3.00	1	32	0.68
	2	57	1.36
	3	76	2.04
	4	76	2.72

**TABLE C - MANDREL DIAMETERS AND LOADS FOR  
FINISHED WIRES OR CORES**

Wire Size (mm <sup>2</sup> )	Mandrel Diameter (mm)	Weight (kg)
0.06	10.0	0.23
0.08	10.0	0.23
0.15	12.5	0.23
0.21	12.5	0.45
0.34	20.0	0.45
0.60	20.0	0.45
0.93	25.4	0.45
1.20	25.4	0.45
2.00	38.1	1.30
3.00	50.8	1.36

**4.8.8 Cut-through Resistance**

The mean load measured during the required tests shall not be less than the relevant value specified below:-

Wire Size (mm <sup>2</sup> )	0.06	0.08	0.15	0.21	0.34	0.60	0.93	1.20	2.00	3.00
Cut-through Load (kg)	1.0	1.5	2	2.5	3.5	4.5	5.5	6.5	7	7.5

**4.8.9 Notch Resistance**

The depth of notch shall be one third of the nominal wall thickness.

**4.8.10 Flammability**

No particular conditions are applicable.

**4.8.11 Resistance to Fluids**

No particular conditions are applicable.

**4.8.12 Surface Resistance**

No particular conditions are applicable.

**4.8.13 Abrasion Resistance**

The weight to be applied to the needle is specified below:-

Wire Size (mm <sup>2</sup> )	0.06	0.08	0.15	0.21	0.34	0.60	0.93	1.20	2.00	3.00
Scrape Abrasion (kg)	0.2	0.2	0.3	0.3	0.4	0.4	0.5	0.6	0.9	0.9

**4.8.14 Soldering**

No particular conditions are applicable.

**4.8.15 Solderability (Applicable to the shield only)**

RMA type flux according to MIL-F-14256 shall be used.

**4.8.16 Radiation Resistance**

No particular conditions are applicable.

**4.8.17 Overload Resistance**

No particular conditions are applicable.

**4.8.18 Long-term Ageing Test**

The long-term ageing temperature shall be +200°C. For shielded cables, a change in the shield's aspect shall not be cause for rejection.

**4.8.19 Anthony and Brown Test**

No particular conditions are applicable.

**TABLE 2 - ELECTRICAL MEASUREMENTS AT ROOM TEMPERATURE**

No.	CHARACTERISTICS	SPEC. AND/OR TEST METHOD	TEST CONDITION	LIMITS	UNIT
1	Conductor Resistance	ESCC No. 3901, Section 9	Para 9.5	Table 1(a)	Ω/km
2	Spark Test	ESCC No. 3901, Section 9	Para 9.6	Insulation : 3.0 Jacket : 1.5	kV
3	Voltage Test	ESCC No. 3901, Section 9	Para 9.7	Para 9.7	kV
4	Insulation Resistance	ESCC No. 3901, Section 9	Para 9.8	Insulation : 750 Jacket : 300	MΩ.km
5	Surface Resistance	ESCC No. 3901, Section 9	Para 9.22	: 125	MΩ.mm

	<p style="text-align: center;">ESCC Detail Specification No. 3901/020</p>	<p style="text-align: right;">PAGE 22 ISSUE 3</p>
---	---	---

**APPENDIX 'A'**

Page 1 of 1

**AGREED DEVIATIONS FOR TYCO ELECTRONICS (UK) LTD. (GB)**

ITEMS AFFECTED	DESCRIPTION OF DEVIATIONS
Para. 4.2.1	<p>The silver coating thickness on soft annealed copper may be determined by electron microscopy and electromechanical mass removal calculation (Kocur technique). The electron microscope shall have a magnification greater than <math>\times 600</math> and enable measurement of the minimal radial-thickness of a single strand.</p> <p><b><u>N.B.</u></b> The criteria specified in ESCC Generic Specification No. 3901 Para. 5.3.2 remain unchanged.</p>
Para. 4.2.2	<p>"Stripping Capability" may be performed using the test methods specified below:-</p> <p>The stripping of the wire insulation shall be conducted using a mechanical wire stripper with preset precision die blades designed for wires conforming to MIL-W-22759. The following procedure shall be used to assess the wire's strippability:-</p> <ol style="list-style-type: none"> <li>(a) The appropriate set of die blades are selected and correctly positioned in the hand held tool.</li> <li>(b) The wire is positioned on the appropriately sized die and 25mm of the insulation is stripped.</li> </ol> <p>The insulation must strip on the first application of the hand tool without difficulty.</p> <p>Stripping of the cable jacket shall be conducted with a hand held tool to make a shallow notch in the jacket at a distance of 50mm from the cable end. The cable is then gently flexed to propagate the notch through the jacket wall and the excess jacket material is then removed by hand with a firm pulling and twisting action.</p> <p>Alternatively, thermal strippers can be used for both the wire insulation and the cable jacket. In keeping with industrial hygiene practices, avoid inhalation of smoke or fumes arising from the thermal strippers.</p> <p><b><u>N.B.</u></b> The criteria specified in ESCC Generic Specification No. 3901 Para. 9.9 remain unchanged.</p>
Paras. 4.2.4 and 4.2.5	<p>Para. 9.18, Cut-through Resistance: The load may be applied directly to the needle, in which case the rate of loading shall be 6.0kg/minute.</p>