



**DIODES, MICROWAVE, SILICON,  
PIN, FAST SWITCHING,  
BASED ON TYPES DH50151 TO DH50157  
ESCC Detail Specification No. 5513/031**

**ISSUE 1  
October 2002**



	ESCC Detail Specification		PAGE ii ISSUE 1
---	---------------------------	--	--------------------

### **LEGAL DISCLAIMER AND COPYRIGHT**

European Space Agency, Copyright © 2002. All rights reserved.

The European Space Agency disclaims any liability or responsibility, to any person or entity, with respect to any loss or damage caused, or alleged to be caused, directly or indirectly by the use and application of this ESCC publication.

This publication, without the prior permission of the European Space Agency and provided that it is not used for a commercial purpose, may be:

- copied in whole in any medium without alteration or modification.
- copied in part, in any medium, provided that the ESCC document identification, comprising the ESCC symbol, document number and document issue, is removed.



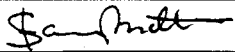

**european space agency  
agence spatiale européenne**

Pages 1 to 25

**DIODES, MICROWAVE, SILICON,  
PIN, FAST SWITCHING,  
BASED ON TYPES DH50151 TO DH50157  
ESA/SCC Detail Specification No. 5513/031**



**space components  
coordination group**

Issue/Rev.	Date	Approved by	
		SCCG Chairman	ESA Director General or his Deputy
Issue 1	July 1997		



**SCC**

ESA/SCC Detail Specification  
No. 5513/031

PAGE 2

ISSUE 1

**DOCUMENTATION CHANGE NOTICE**

Rev. Letter	Rev. Date	Reference	CHANGE Item	Approved DCR No.

**TABLE OF CONTENTS**

	<u>Page</u>
<b>1. <u>GENERAL</u></b>	<b>5</b>
1.1 Scope	5
1.2 Component Type Variants	5
1.3 Maximum Ratings	5
1.4 Parameter Derating Information	5
1.5 Physical Dimensions	5
1.6 Functional Diagram	5
1.7 Handling Precautions	5
<b>2. <u>APPLICABLE DOCUMENTS</u></b>	<b>5</b>
<b>3. <u>TERMS, DEFINITIONS, ABBREVIATIONS, SYMBOLS AND UNITS</u></b>	<b>5</b>
<b>4. <u>REQUIREMENTS</u></b>	<b>14</b>
4.1 General	14
4.2 Deviations from Generic Specification	14
4.2.1 Deviations from Special In-process Controls	14
4.2.2 Deviations from Final Production Tests	14
4.2.3 Deviations from Burn-in and Electrical Measurements	14
4.2.4 Deviations from Qualification Tests	14
4.2.5 Deviations from Lot Acceptance Tests	15
4.3 Mechanical and Environmental Requirements	15
4.3.1 Dimension Check	15
4.3.2 Weight	15
4.3.3 Terminal Strength	15
4.4 Materials and Finishes	15
4.4.1 Case	15
4.4.2 Lead Materials and Finish	16
4.5 Marking	16
4.5.1 General	16
4.5.2 Cathode Identification	16
4.5.3 The SCC Component Number	16
4.5.4 Traceability Information	16
4.6 Electrical Measurements	16
4.6.1 Electrical Measurements at Room Temperature	16
4.6.2 Electrical Measurements at High and Low Temperatures	17
4.6.3 Circuits for Electrical Measurements	17
4.7 Burn-in Tests	17
4.7.1 Parameter Drift Values	17
4.7.2 Conditions for High Temperature Reverse Bias Burn-in	17
4.7.3 Conditions for Power Burn-in	17
4.7.4 Electrical Circuits for High Temperature Reverse Bias and Power Burn-in	17
4.8 Environmental and Endurance Tests	23
4.8.1 Electrical Measurements on Completion of Environmental Tests	23
4.8.2 Electrical Measurements at Intermediate Points and on Completion of Endurance Tests	23
4.8.3 Conditions for Operating Life Tests	23
4.8.4 Electrical Circuits for Operating Life Tests	23
4.9 Total Dose Irradiation Testing	23
4.10 Special Testing	23

**SCC**ESA/SCC Detail Specification  
No. 5513/031

PAGE 4

ISSUE 1

Page**TABLES**

1(a)	Type Variants	6
1(b)	Maximum Ratings	8
2	Electrical Measurements at Room Temperature - D.C. Parameters	18
	Electrical Measurements at Room Temperature - A.C. Parameters	18
3	Electrical Measurements at High and Low Temperatures	19
4	Parameter Drift Values	19
5(a)	Conditions for High Temperature Reverse Bias Burn-in	21
5(b)	Conditions for Power Burn-in	21
5(c)	Conditions for Operating Life Tests	21
6	Electrical Measurements at Intermediate Points and on Completion of Endurance Testing	24
7	Electrical Measurements During and on Completion of Irradiation Testing	24

**FIGURES**

1	Parameter Derating Information	9
2	Physical Dimensions	10
3	Functional Diagram	13
4	Circuits for Electrical Measurements	20
5(a)	Electrical Circuit for High Temperature Reverse Bias Burn-in	22
5(b)	Electrical Circuit for Power Burn-in and Operating Life Tests	22
6	Bias Conditions for Irradiation Testing	24

**APPENDICES (Applicable to specific Manufacturers only)**

'A'	Agreed Deviations for Tekelec/Temex (F)	25
-----	---	----

**1. GENERAL****1.1 SCOPE**

This specification details the ratings, physical and electrical characteristics, test and inspection data for a Diode, Microwave, Silicon, PIN, Fast Switching, based on Types DH50151 to DH50157. It shall be read in conjunction with ESA/SCC Generic Specification No. 5010, the requirements of which are supplemented herein.

**1.2 COMPONENT TYPE VARIANTS**

Variants of the basic diodes specified herein, which are also covered by this specification are given in Table 1(a).

**1.3 MAXIMUM RATINGS**

The maximum ratings, which shall not be exceeded at any time during use or storage, applicable to the diodes specified herein, are as scheduled in Table 1(b).

**1.4 PARAMETER DERATING INFORMATION**

The derating information applicable to the diodes specified herein is shown in Figure 1.

**1.5 PHYSICAL DIMENSIONS**

The physical dimensions of the diodes specified herein are shown in Figure 2.

**1.6 FUNCTIONAL DIAGRAM**

The functional diagram, showing lead identification, of the diodes specified herein, is shown in Figure 3.

**1.7 HANDLING PRECAUTIONS**

These devices are susceptible to damage by electrostatic discharge. Therefore, suitable precautions shall be employed for protection during all phases of manufacture, testing, packaging, shipment and any handling.

These components are Categorised as Class 2 with a Minimum Critical Path Failure Voltage of 1400V.

**2. APPLICABLE DOCUMENTS**

The following documents form part of this specification and shall be read in conjunction with it:

- (a) ESA/SCC Generic Specification No. 5010 for Discrete Microwave Semiconductor Components.

**3. TERMS, DEFINITIONS, ABBREVIATIONS, SYMBOLS AND UNITS**

For the purpose of this specification, the terms, definitions, abbreviations, symbols and units specified in ESA/SCC Basic Specification No. 21300 shall apply. In addition, the following symbols are used:

- $C_T$  = Total Capacitance.



**TABLE 1(a) - TYPE VARIANTS**

(1) VARIANT	(2) BASED ON TYPE	(3) FIGURE	(4) TOTAL CAPACITANCE $C_T$ (pF) (MAX.)	(5) FORWARD SERIES RESISTANCE $R_{SF}$ ( $\Omega$ ) (MAX.)	(6) MINORITY CARRIER LIFETIME $\tau_L$ (ns) (MIN.)	(7) BODY-LID AND LEAD MATERIAL AND FINISH
01	DH50151	2(a)	0.19	2.0	160	D7-E2
02	DH50151	2(b)	0.19	2.0	160	D7
03	DH50151	2(c)	0.19	2.0	160	D7-E2
04	DH50151	2(d)	0.19	2.0	160	D7-E2
05	DH50151	2(e)	0.19	2.0	160	D7-E2
06	DH50151	2(f)	0.19	2.0	160	D7-E2
07	DH50151	2(g)	0.26	2.0	160	A7-D7
08	DH50152	2(a)	0.21	1.7	185	D7-E2
09	DH50152	2(b)	0.21	1.7	185	D7
10	DH50152	2(c)	0.21	1.7	185	D7-E2
11	DH50152	2(d)	0.21	1.7	185	D7-E2
12	DH50152	2(e)	0.21	1.7	185	D7-E2
13	DH50152	2(f)	0.21	1.7	185	D7-E2
14	DH50152	2(g)	0.28	1.7	185	A7-D7
15	DH50153	2(a)	0.25	1.5	240	D7-E2
16	DH50153	2(b)	0.25	1.5	240	D7
17	DH50153	2(c)	0.25	1.5	240	D7-E2
18	DH50153	2(d)	0.25	1.5	240	D7-E2
19	DH50153	2(e)	0.25	1.5	240	D7-E2
20	DH50153	2(f)	0.25	1.5	240	D7-E2
21	DH50153	2(g)	0.32	1.5	240	A7-D7
22	DH50154	2(a)	0.30	1.4	400	D7-E2
23	DH50154	2(b)	0.30	1.4	400	D7
24	DH50154	2(c)	0.30	1.4	400	D7-E2
25	DH50154	2(d)	0.30	1.4	400	D7-E2
26	DH50154	2(e)	0.30	1.4	400	D7-E2
27	DH50154	2(f)	0.30	1.4	400	D7-E2
28	DH50154	2(g)	0.37	1.4	400	A7-D7
29	DH50155	2(a)	0.36	1.0	440	D7-E2
30	DH50155	2(b)	0.36	1.0	440	D7
31	DH50155	2(c)	0.36	1.0	440	D7-E2
32	DH50155	2(d)	0.36	1.0	440	D7-E2
33	DH50155	2(e)	0.36	1.0	440	D7-E2
34	DH50155	2(f)	0.36	1.0	440	D7-E2
35	DH50155	2(g)	0.43	1.0	440	A7-D7





**TABLE 1(a) - TYPE VARIANTS (CONTINUED)**

(1) VARIANT	(2) BASED ON TYPE	(3) FIGURE	(4) JUNCTION CAPACITANCE $C_J$ (pF)  (MAX.)	(5) FORWARD SERIES RESISTANCE $R_{SF}$ ( $\Omega$ ) (MAX.)	(6) MINORITY CARRIER LIFETIME $\tau_L$ (ns) (MIN.)	(7) BODY-LID AND LEAD MATERIAL AND FINISH
36	DH50156	2(a)	0.53	0.8	640	D7-E2
37	DH50156	2(b)	0.53	0.8	640	D7
38	DH50156	2(c)	0.53	0.8	640	D7-E2
39	DH50156	2(d)	0.53	0.8	640	D7-E2
40	DH50156	2(e)	0.53	0.8	640	D7-E2
41	DH50156	2(f)	0.53	0.8	640	D7-E2
42	DH50156	2(g)	0.60	0.8	640	A7-D7
43	DH50157	2(a)	0.73	0.6	760	D7-E2
44	DH50157	2(b)	0.73	0.6	760	D7
45	DH50157	2(c)	0.73	0.6	760	D7-E2
46	DH50157	2(d)	0.73	0.6	760	D7-E2
47	DH50157	2(e)	0.73	0.6	760	D7-E2
48	DH50157	2(f)	0.73	0.6	760	D7-E2
49	DH50157	2(g)	0.80	0.6	760	A7-D7

**TABLE 1(b) - MAXIMUM RATINGS**

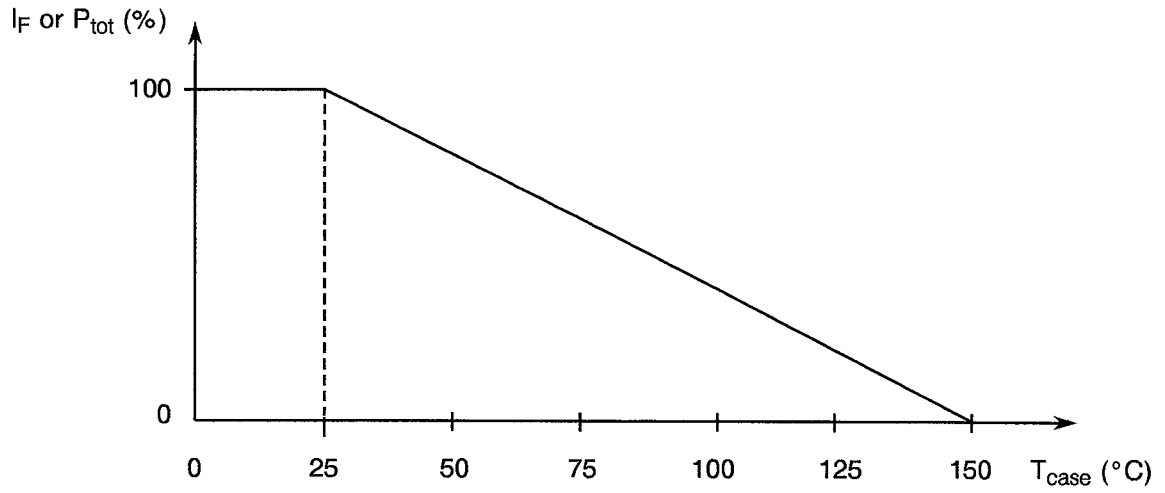
No.	CHARACTERISTIC	SYMBOL	MAXIMUM RATINGS	UNIT	REMARKS
1	D.C. Reverse Voltage	$V_R$	- 150	V	$I_R = 10\mu A$
2	D.C. Forward Current (Continuous) Variants 01 to 28 Variants 29 to 49	$I_F$	100 200	mA	Note 1
3	R.F. Power Dissipation Variants 01 to 06, 08 to 13 Variants 07, 14 Variants 15 to 20 Variant 21 Variants 22 to 27 Variant 28 Variants 29 to 34 Variant 35 Variants 36 to 41, 43 to 48 Variants 42, 49	$P_{tot}$	1.38 2.50 1.47 2.70 1.56 3.10 1.66 3.50 1.78 4.10	W	Note 1
4	Operating Temperature Range	$T_{op}$	- 55 to + 150	°C	$T_{case}$
5	Storage Temperature Range	$T_{stg}$	- 65 to + 175	°C	
6	Soldering Temperature	$T_{sol}$	+ 220	°C	Note 2
7	Thermal Resistance (Junction to Case) Variants 01 to 06, 08 to 13 Variants 07, 14 Variants 15 to 20 Variant 21 Variants 22 to 27 Variant 28 Variants 29 to 34 Variant 35 Variants 36 to 41, 43 to 48 Variants 42, 49	$R_{TH(J-C)}$	90 50 85 45 80 40 75 35 70 30	°C/W	

**NOTES**

1. At  $T_{case} = +25^\circ C$ . For derating at  $T_{case} > +25^\circ C$ , see Figure 1.
2. Duration 5 seconds maximum and the same termination shall not be resoldered until 3 minutes have elapsed.



**FIGURE 1 - PARAMETER DERATING INFORMATION**

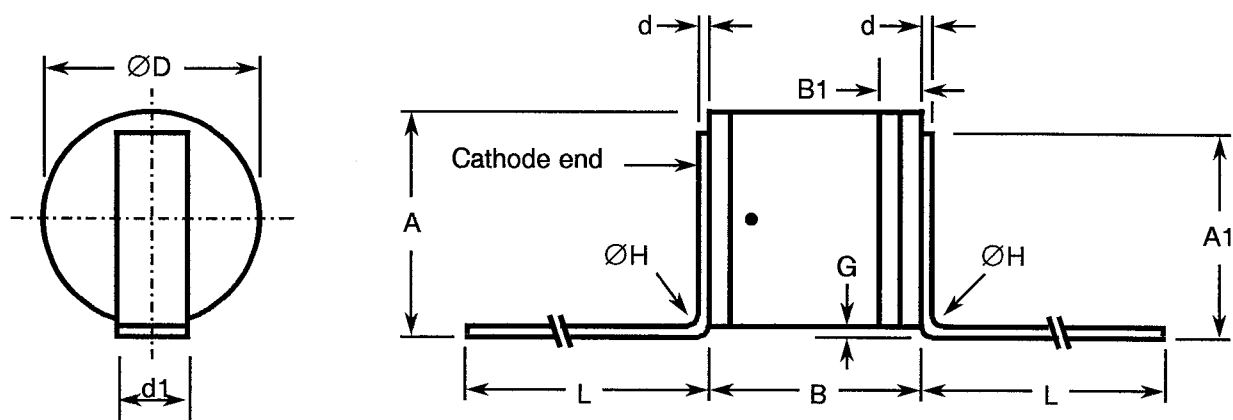


**Forward Current or Power Dissipation versus Temperature**

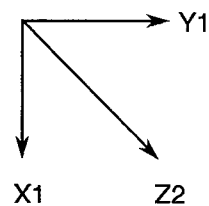


**FIGURE 2 - PHYSICAL DIMENSIONS**

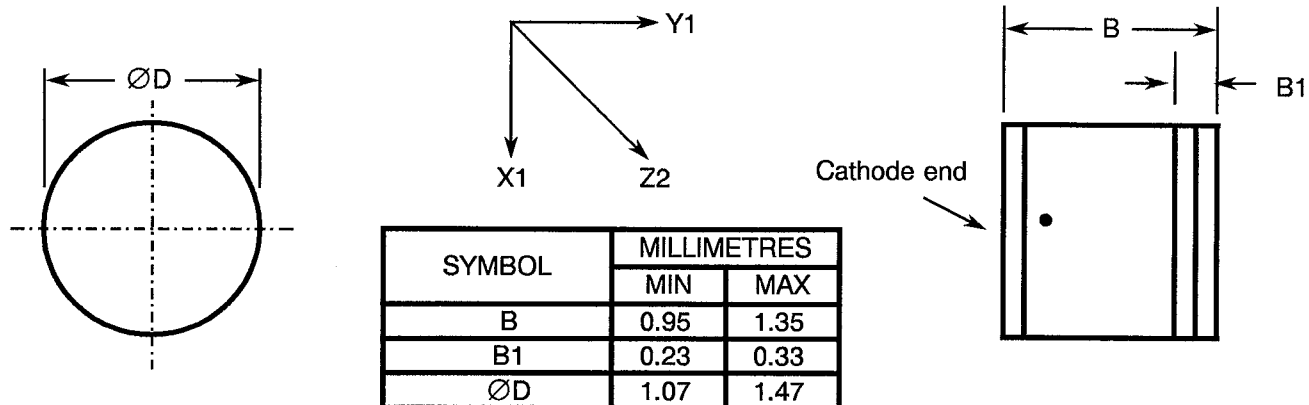
**FIGURE 2(a) - VARIANTS 01, 08, 15, 22, 29, 36, 43**



SYMBOL	MILLIMETRES	
	MIN.	MAX.
A	1.30	1.90
A1	1.22	1.82
B	0.95	1.35
B1	0.23	0.33
d	0.06	0.10
d1	0.55	0.65
ØD	1.07	1.47
G	0.10	0.50
ØH	-	0.30
L	2.50	-



**FIGURE 2(b) - VARIANTS 02, 09, 16, 23, 30, 37, 44**



SYMBOL	MILLIMETRES	
	MIN	MAX
B	0.95	1.35
B1	0.23	0.33
ØD	1.07	1.47



**FIGURE 2 - PHYSICAL DIMENSIONS (CONTINUED)**

FIGURE 2(c) - VARIANTS 03, 10, 17, 24, 31, 38, 45

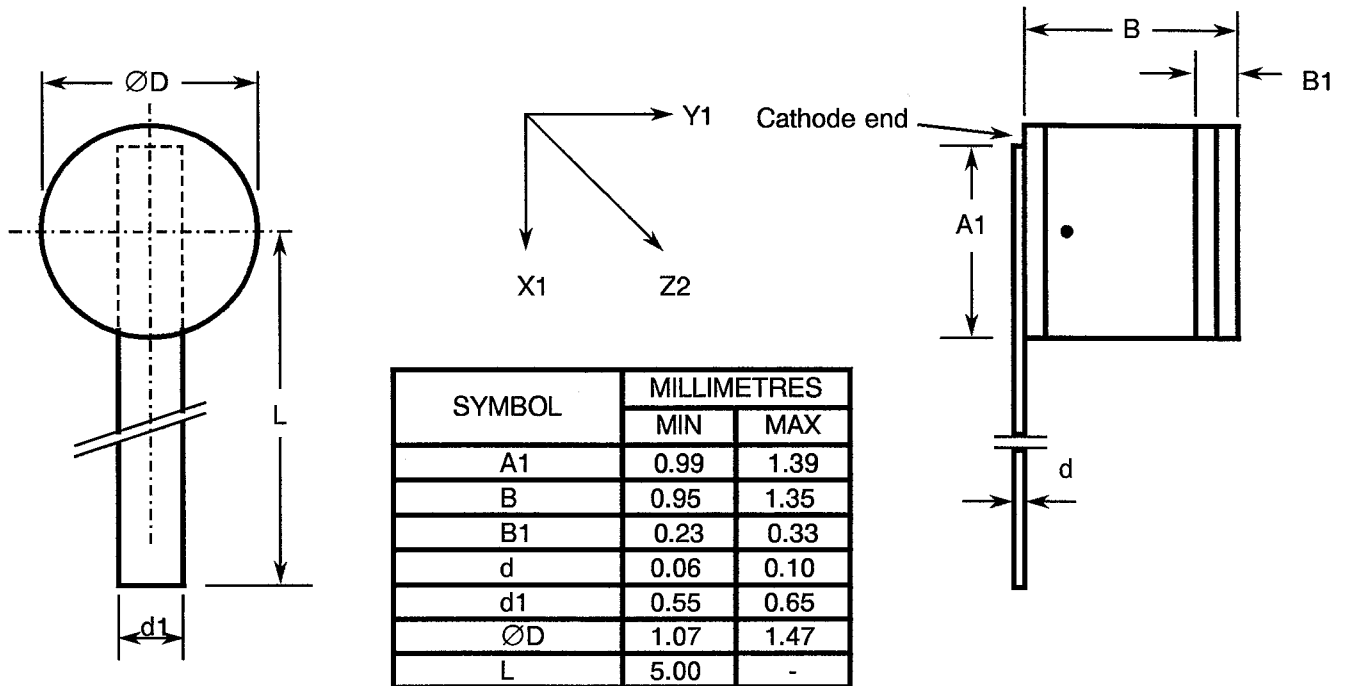
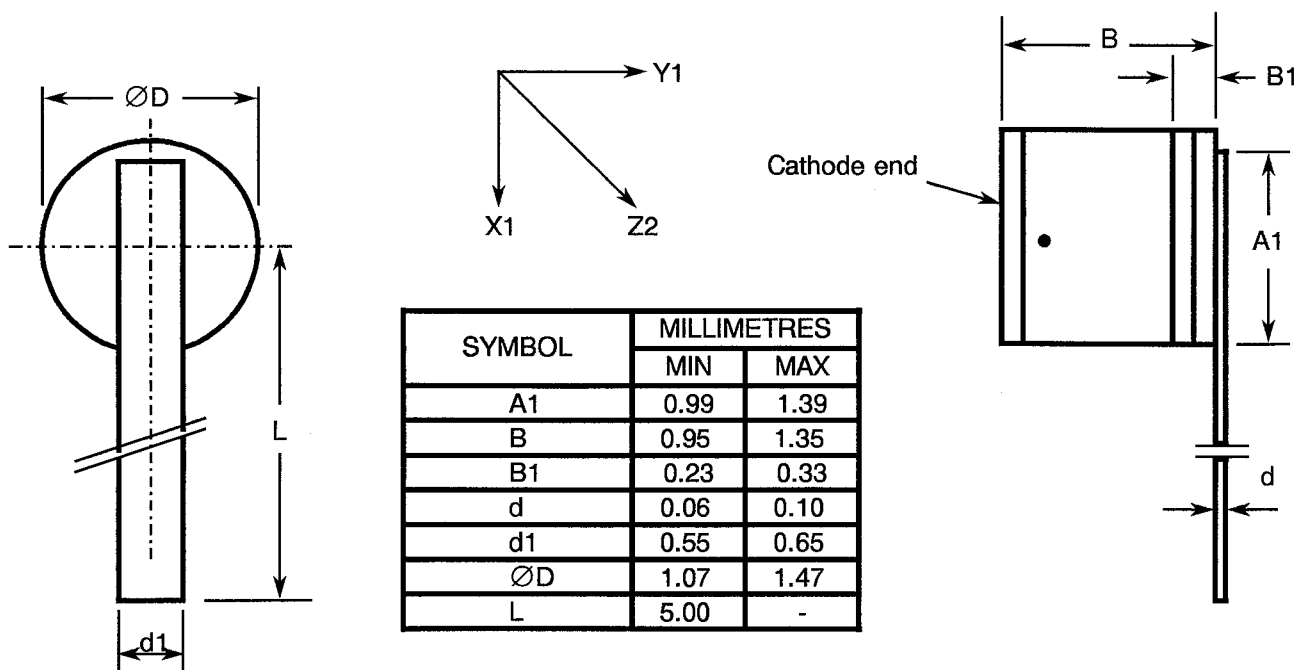


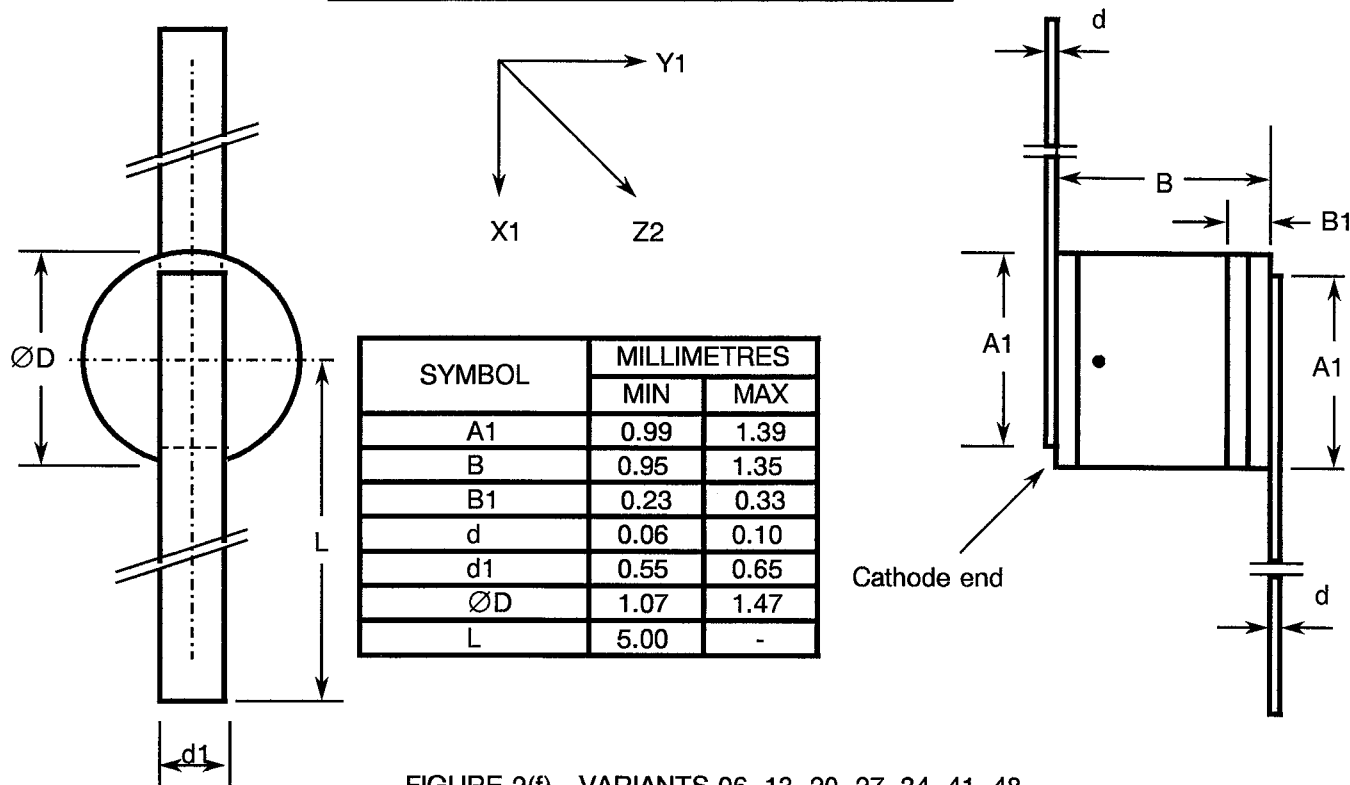
FIGURE 2(d) - VARIANTS 04, 11, 18, 25, 32, 39, 46



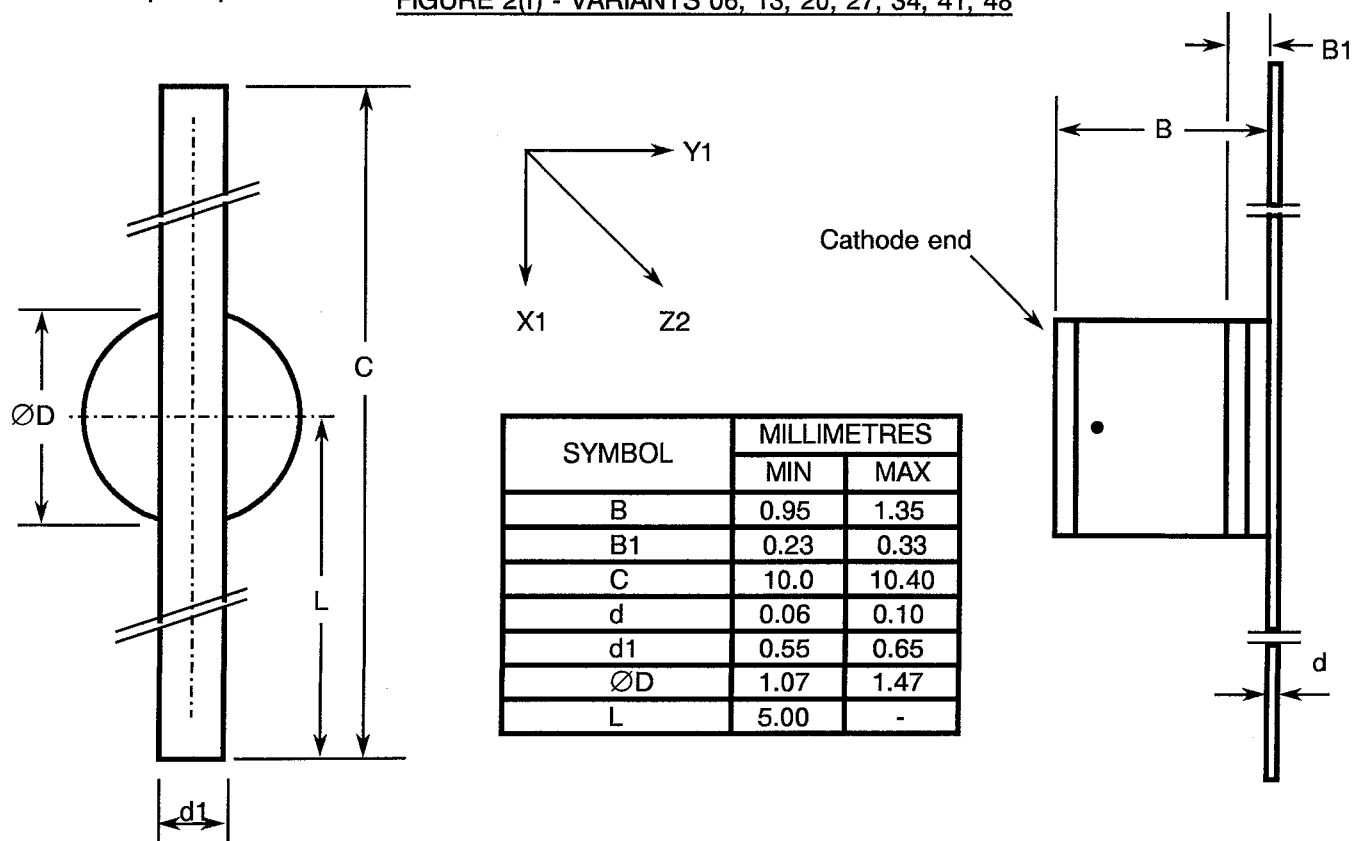


**FIGURE 2 - PHYSICAL DIMENSIONS (CONTINUED)**

**FIGURE 2(e) - VARIANTS 05, 12, 19, 26, 33, 40, 47**



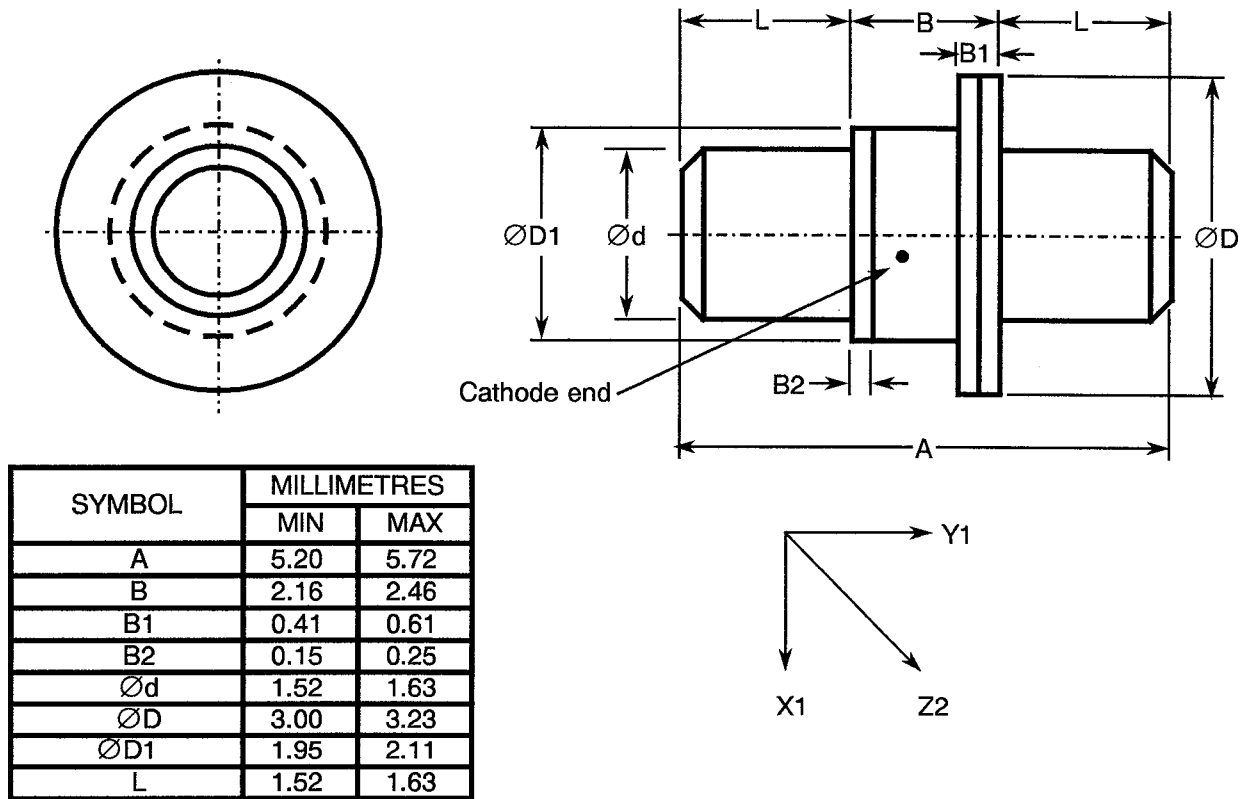
**FIGURE 2(f) - VARIANTS 06, 13, 20, 27, 34, 41, 48**



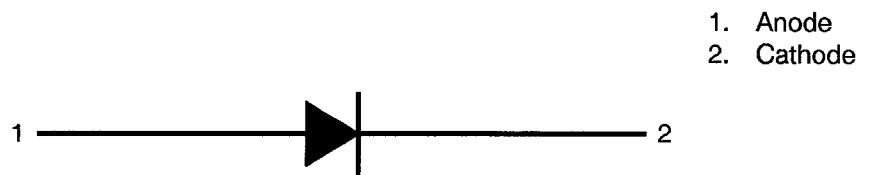


**FIGURE 2 - PHYSICAL DIMENSIONS (CONTINUED)**

FIGURE 2(g) - VARIANTS 07, 14, 21, 28, 35, 42, 49



**FIGURE 3 - FUNCTIONAL DIAGRAM**



**NOTES**

1. The cathode end shall be marked with a black dot. The marking will not be on the cathode connection but adjacent to it.



#### **4. REQUIREMENTS**

##### **4.1 GENERAL**

The complete requirements for procurement of the diodes specified herein shall be as stated in this specification and ESA/SCC Generic Specification No. 5010 for Discrete Microwave Semiconductor Components. Deviations from the Generic Specification applicable to this specification only, are listed in Para. 4.2.

Deviations from the applicable Generic Specification and this Detail Specification, formally agreed with specific Manufacturers on the basis that the alternative requirements are equivalent to the ESA/SCC requirements and do not affect the components' reliability, are listed in the appendices attached to this specification.

##### **4.2 DEVIATIONS FROM GENERIC SPECIFICATION**

###### **4.2.1 Deviations from Special In-process Controls**

- (a) Para. 5.3, Wafer Lot Acceptance: S.E.M. Inspection shall be performed on 3 dice, after Wafer Dicing.
- (b) Para. 5.3, Wafer Lot Acceptance : Minority Carrier Lifetime measurements shall be performed on 10 devices assembled into one of the cases defined in Figure 2 of this specification, or similar.

###### **4.2.2 Deviations from Final Production Tests (Chart II)**

- (a) Para. 6.2, Pre-burn-in: Shall be performed in accordance with Para. 9.21(a) using the conditions specified in Table 5(a) of this specification for a duration of 48 hours minimum.
- (b) Para. 9.2.2, Die Shear: Individual forces need not be recorded and the minimum residual die area shall be  $\geq 50\%$  of the original die size.
- (c) Para 9.6, Constant Acceleration: Shall not be performed.
- (d) Para. 9.14, Vibration, Variable Frequency: Shall not be performed.

###### **4.2.3 Deviations from Burn-in and Electrical Measurements (Chart III)**

- (a) Para. 7.1.1(a), High Temperature Reverse Bias Burn-in: Shall be performed at 75% of rated  $V_R$ .
- (b) Para. 9.9.1, Initial Parameter Drift Value measurements : Parameters measured in Chart II during Para. 9.9.3, Electrical Measurements at Room Temperature, need not be repeated for Initial Measurements.

###### **4.2.4 Deviations from Qualification Tests (Chart IV)**

- (a) Para. 9.2.4, Die-Shear: Individual forces need not be recorded and the minimum residual die area shall be  $\geq 50\%$  of the original die size.
- (b) Para. 9.14, Vibration Test: Shall not be performed.
- (c) Para. 9.15, Constant Acceleration : Shall not be performed.
- (d) Para. 9.23, Special Testing: Shall not be performed.



**4.2.5 Deviations from Lot Acceptance Tests (Chart V)**

- (a) Para. 9.14, Vibration: Shall not be performed.
- (b) Para. 9.15, Constant Acceleration : Shall not be performed.
- (c) Para. 9.23, Special Testing: Shall not be performed.

**4.3 MECHANICAL AND ENVIRONMENTAL REQUIREMENTS****4.3.1 Dimension Check**

The dimensions of the diodes specified herein shall be checked. They shall conform to those shown in Figure 2.

**4.3.2 Weight**

The maximum weight of the diodes specified herein shall be 0.15 grammes for Variants 07, 14, 21, 28, 35, 42 and 49 and 0.02 grammes for all other Variants.

**4.3.3 Terminal Strength**

The requirements for terminal strength testing are specified in Section 9 of ESA/SCC Generic Specification No. 5010. The test conditions shall be as follows:-

**(a) Condition: 'A' (Tension)**

Variants 01, 03, 04, 05, 06, 08, 10, 11, 12, 15, 17, 18, 19, 20, 22, 24, 25, 26, 27, 29, 31, 32, 33, 34, 36, 38, 39, 40, 41, 43, 45, 46, 47 and 48:

- Force: 1.25N.
- Duration: 10 seconds.

**4.4 MATERIALS AND FINISHES**

The materials and finishes shall be as specified herein. Where a definite material is not specified, a material which will enable the diodes specified herein to meet the performance requirements of this specification shall be used. Acceptance or approval of any constituent material shall not guarantee acceptance of the finished product.

**4.4.1 Case**

The case shall be hermetically sealed and have a ceramic body. The lid shall be welded or preform soldered.



4.4.2 Lead Materials and Finish

- (a) For Variants 01, 03, 04, 05, 06, 08, 10, 11, 12, 13, 15, 17, 18, 19, 20, 22, 24, 25, 26, 27, 29, 31, 32, 33, 34, 36, 38, 39, 40, 41, 43, 45, 46, 47, and 48, the body/lid material shall be Type 'D' with Type '7' finish and the lead material shall be Type 'E' with Type '2' finish, in accordance with the requirements of ESA/SCC Basic Specification No. 23500.
- (b) For Variants 02, 09, 16, 23, 30, 37 and 44, the body and lid material shall be Type 'D' with Type '7' finish, in accordance with the requirements of ESA/SCC Basic Specification No. 23500.
- (c) For Variants 07, 14, 21, 28, 35, 42 and 49, the body material shall be Type 'A' with Type '7' finish, and the lid material shall be Type 'D' with Type '7' finish, in accordance with the requirements of ESA/SCC Basic Specification No. 23500.

4.5 MARKING

4.5.1 General

The marking of all components delivered to this specification shall be in accordance with the requirements of ESA/SCC Basic Specification No. 21700 and the following paragraphs. When the component is too small to accommodate all of the marking specified, as much as space permits shall be marked and the marking information, in full, shall accompany the component in its primary package.

The information to be marked and the order of precedence, shall be as follows:-

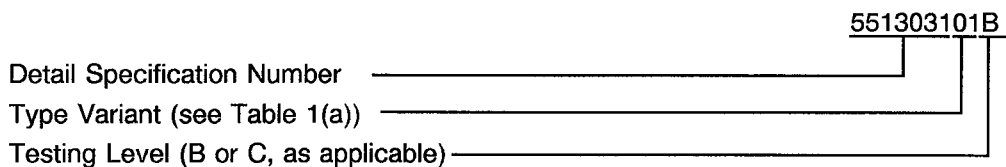
- (a) Cathode Identification.
- (b) The SCC Component Number.
- (c) Traceability Information.

4.5.2 Cathode Identification

Cathode identification shall be as shown in Figures 2 and 3 of this specification.

4.5.3 The SCC Component Number

Each component shall bear the SCC Component Number which shall be constituted and marked as follows:



4.5.4 Traceability Information

Each component shall be marked in respect of traceability information as defined in ESA/SCC Basic Specification No. 21700.

4.6 ELECTRICAL MEASUREMENTS

4.6.1 Electrical Measurements at Room Temperature

The parameters to be measured at room temperature are scheduled in Table 2. Unless otherwise specified, the measurements shall be performed at  $T_{amb} = +22 \pm 3 \text{ }^\circ\text{C}$ .



#### 4.6.2 Electrical Measurements at High and Low Temperatures

The parameters to be measured at high and low temperatures are scheduled in Table 3. Unless otherwise specified, the measurements shall be performed at  $+150(+0-3)$  °C.

#### 4.6.3 Circuits for Electrical Measurements

Circuits for use in performing electrical measurements listed in Table 2 of this specification are shown in Figure 4.

#### 4.7 BURN-IN TESTS

Burn-in shall be Category 3 of Chart III(a).

##### 4.7.1 Parameter Drift Values

The parameter drift values applicable to burn-in are specified in Table 4 of this specification. Unless otherwise stated, the measurements shall be performed at  $T_{amb} = +22 \pm 3$  °C. The parameter drift values ( $\Delta$ ) applicable to the scheduled parameters shall not be exceeded. In addition to these drift value requirements for a given parameter, the appropriate limit value specified in Table 2 shall not be exceeded.

##### 4.7.2 Conditions for High Temperature Reverse Bias Burn-in

The requirements for the high temperature reverse bias burn-in are specified in Section 7 of ESA/SCC Generic Specification No. 5010. The conditions for high temperature reverse bias burn-in shall be as specified in Table 5(a) of this specification.

##### 4.7.3 Conditions for Power Burn-in

The requirements for power burn-in are specified in Section 7 of ESA/SCC Generic Specification No. 5010. The conditions for power burn-in shall be as specified in Table 5(b) of this specification.

##### 4.7.4 Electrical Circuits for High Temperature Reverse Bias and Power Burn-in

Circuits for use in performing the high temperature reverse bias and power burn-in tests are shown in Figures 5(a) and 5(b) of this specification.



**TABLE 2 - ELECTRICAL MEASUREMENTS AT ROOM TEMPERATURE - D.C. PARAMETERS**

No.	CHARACTERISTICS	SYMBOL	MIL-STD-750 TEST METHOD	TEST CONDITIONS	LIMITS		UNIT
					MIN.	MAX.	
1	Reverse Current 1	$I_{R1}$	4016	$V_R = -150V$	-	10	$\mu A$
2	Reverse Current 2	$I_{R2}$	4016	$V_R = -75V$	-	500	nA
3	Forward Voltage	$V_F$	4011	$I_F = 100mA$	-	1.1	V
4	Thermal Resistance	$R_{TH(J-C)}$	3101	Variants 01 to 21 Applied Power = 0.5W Variants 22 to 49 Applied Power = 1.0W Note 1	-	Note 2	$^{\circ}C/W$

**NOTES**

1. Pulsed measurement, pulse width = 10ms.
2. See Item 7 of Table 1(b).

**TABLE 2 - ELECTRICAL MEASUREMENTS AT ROOM TEMPERATURE - A.C. PARAMETERS**

No.	CHARACTERISTICS	SYMBOL	MIL-STD-750 TEST METHOD	TEST FIG.	TEST CONDITIONS	LIMITS		UNIT
						MIN.	MAX.	
5	Total Capacitance	$C_T$	4001	-	$V_R = -50V$ $f = 1.0MHz$	-	Note 1	pF
6	Forward Series Resistance	$R_{SF}$	4056	-	$I_F = 10mA$ $f_o = 120MHz$	-	Note 2	$\Omega$
7	Minority Carrier Lifetime	$\tau_L$	-	4(a)	$I_F = 10mA$ $I_R = 6.0mA$ Note 3	Note 4	-	ns

**NOTES**

1. See Column 4 of Table 1(a). Junction capacitance = Total capacitance - case capacitance.  
Typical case capacitance for cases in Figures 2(a) to 2(f) = 0.12pF.  
Typical case capacitance for cases in Figure 2(g) = 0.18pF.
2. See column 5 of Table 1(a).
3. Measurements to be performed only during Wafer Lot Acceptance on 10 devices assembled into one of the cases defined in Figure 2 of this specification, or similar..
4. See Column 6 of Table 1(a).

**TABLE 3 - ELECTRICAL MEASUREMENTS AT HIGH AND LOW TEMPERATURES**

No.	CHARACTERISTICS	SYMBOL	SPEC AND/OR TEST METHOD	TEST CONDITIONS	LIMITS		UNIT
					MIN.	MAX.	
2	Reverse Current	$I_R$	As per Table 2	As per Table 2	-	50	$\mu A$

**TABLE 4 - PARAMETER DRIFT VALUES**

No.	CHARACTERISTICS	SYMBOL	SPEC.AND/OR TEST METHOD	TEST CONDITIONS	CHANGE LIMITS ( $\Delta$ )	UNIT
2	Reverse Current 2	$I_{R2}$	As per Table 2	As per Table 2	$\pm 50$ (1) or (2) $\pm 100$ (1)	nA %
3	Forward Voltage	$V_F$	As per Table 2	As per Table 2	$\pm 5.0$ (1)	%
5	Total Capacitance	$C_T$	As per Table 2	As per Table 2	$\pm 5.0$ (1)(3)	%

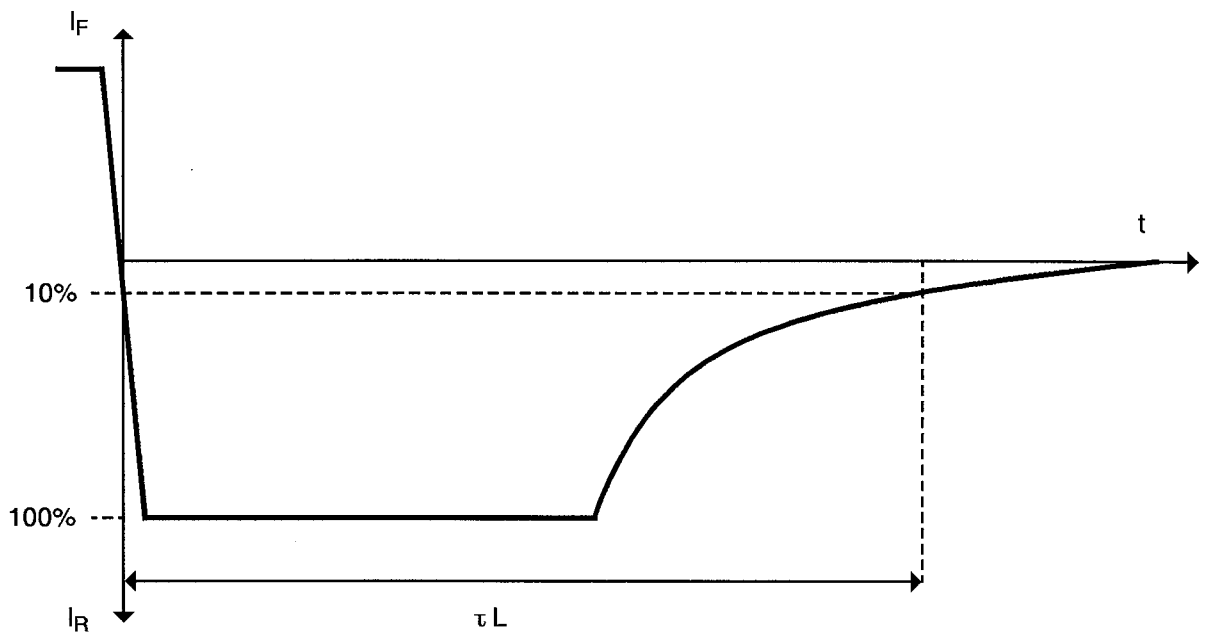
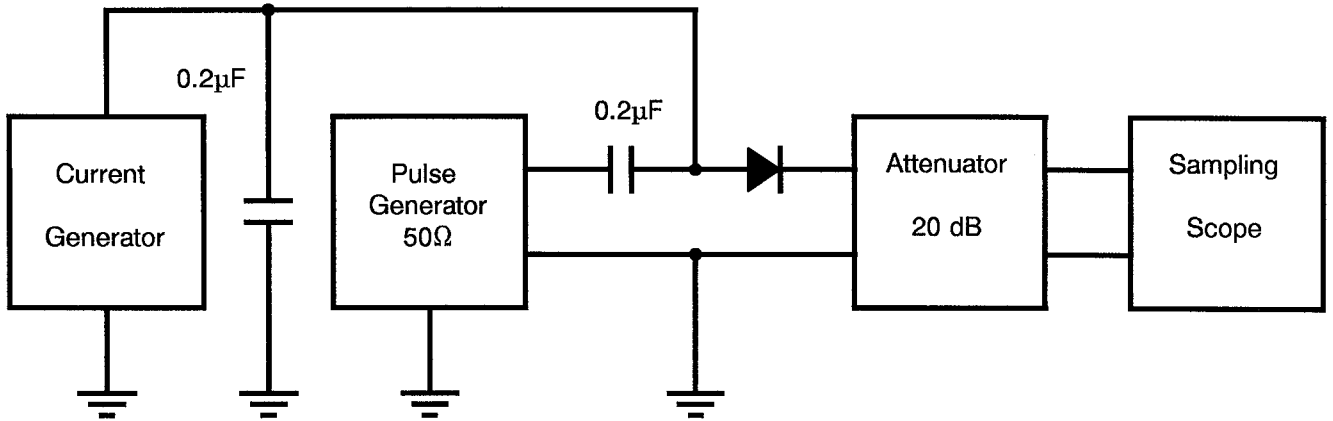
**NOTES**

- $\Delta 1 = \Delta 2 = \Delta 3$
- Whichever is the greater, referred to the initial measurement.
- Rounded upwards to the nearest 0.01pF. If  $C_T < 0.25pF$  then  $\Delta = \pm 10\%$ .



**FIGURE 4 - CIRCUITS FOR ELECTRICAL MEASUREMENTS**

**FIGURE 4(a) - MINORITY CARRIER LIFETIME**



Output waveform

**TABLE 5(a) - CONDITIONS FOR HIGH TEMPERATURE REVERSE BIAS BURN-IN**

No.	CHARACTERISTICS	SYMBOL	CONDITIONS	UNIT
1	Ambient Temperature	$T_{amb}$	+ 150(+ 0 - 3)	°C
2	Reverse Voltage	$V_R$	- 112.5	V

**TABLE 5(b) - CONDITIONS FOR POWER BURN-IN**

No.	CHARACTERISTICS	SYMBOL	CONDITIONS	UNIT
1	Ambient Temperature	$T_{amb}$	+ 125(+ 0 - 3)	°C
2	Forward Current	$I_F$	Note 1	mA

**NOTES**

1. See Table 1(b) Item 2 and Figure 1.

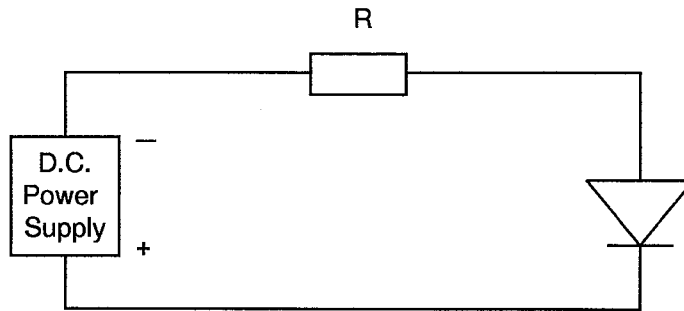
**TABLE 5(c) - CONDITIONS FOR OPERATING LIFE TESTS**

No.	CHARACTERISTICS	SYMBOL	CONDITIONS	UNIT
1	Ambient Temperature 1	$T_{amb1}$	+ 135(+ 0 - 3)	°C
2	Forward Current 1	$I_{F1}$	Note 1	mA
3	Ambient Temperature 2	$T_{amb2}$	+ 125(+ 0 - 3)	°C
4	Forward Current 2	$I_{F2}$	Note 1	mA

**NOTES**

1. See Table 1(b) Item 2 and Figure 1.

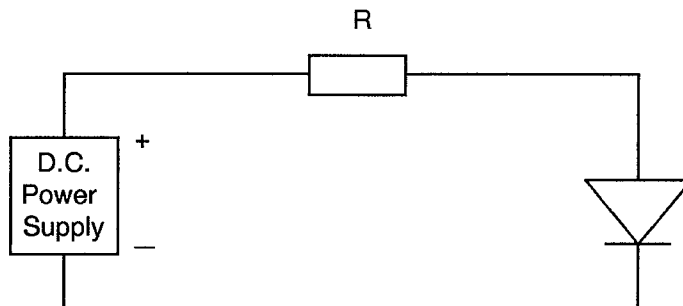
**FIGURE 5(a) - ELECTRICAL CIRCUIT FOR HIGH TEMPERATURE REVERSE BIAS BURN-IN**



**NOTES**

1. At the end of the high temperature reverse bias test,  $T_{amb}$  shall be decreased to room temperature and the reverse bias shall remain applied until  $T_{amb} < +35^{\circ}\text{C}$ .

**FIGURE 5(b) - ELECTRICAL CIRCUIT FOR POWER BURN-IN AND OPERATING LIFE TESTS**







- 4.8 ENVIRONMENTAL AND ENDURANCE TESTS (CHARTS IV AND V OF ESA/SCC GENERIC SPECIFICATION NO. 5010)
- 4.8.1 Electrical Measurements on Completion of Environmental Tests  
The parameters to be measured on completion of environmental tests are scheduled in Table 2. Unless otherwise stated, the measurements shall be performed at  $T_{amb} = +22 \pm 3 \text{ }^\circ\text{C}$ .
- 4.8.2 Electrical Measurements at Intermediate Points and on Completion of Endurance Tests  
The parameters to be measured at intermediate points and on completion of endurance tests are scheduled in Table 6. Unless otherwise stated, the measurements shall be performed at  $T_{amb} = +22 \pm 3 \text{ }^\circ\text{C}$ .
- 4.8.3 Conditions for Operating Life Tests (Part of Endurance Testing)  
The requirements for operating life testing are specified in Section 9 of ESA/SCC Generic Specification No. 5010. The conditions for operating life testing are specified in Table 5(c) of this specification.
- 4.8.4 Electrical Circuits for Operating Life Tests  
The circuit to be used for performance of the operating life test shall be the same as shown in Figure 5(b) for Power Burn-in.
- 4.9 TOTAL DOSE IRRADIATION TESTING  
Not applicable.
- 4.10 SPECIAL TESTING  
Not applicable.

**TABLE 6 - ELECTRICAL MEASUREMENTS AT INTERMEDIATE POINTS AND ON COMPLETION OF ENDURANCE TESTING**

No.	CHARACTERISTICS	SYMBOL	SPEC. AND/OR TEST METHOD	TEST CONDITIONS	LIMITS		UNIT
					MIN.	MAX.	
1	Reverse Current 1	$I_{R1}$	As per Table 2	As per Table 2	-	10	$\mu$ A
2	Reverse Current 2	$I_{R2}$	As per Table 2	As per Table 2	-	500	nA
3	Forward Voltage	$V_F$	As per Table 2	As per Table 2	-	1.1	V
5	Total Capacitance	$C_T$	As per Table 2	As per Table 2	-	Note 1	pF

**NOTES**



1. See Column 4 of Table 1(a)

**FIGURE 6 - BIAS CONDITIONS FOR IRRADIATION TESTING**

Not applicable.

**TABLE 7 - ELECTRICAL MEASUREMENTS DURING AND ON COMPLETION OF IRRADIATION TESTING**

Not applicable.

		<p>ESA/SCC Detail Specification No. 5513/031</p>	<p>PAGE 25 ISSUE 1</p>
---	---	--	----------------------------

**APPENDIX 'A'**

Page 1 of 1

AGREED DEVIATIONS FOR TEKELEC/TEMEX (F)

ITEMS AFFECTED	DESCRIPTION OF DEVIATIONS
Para. 4.2.2	Para. 9.12, Radiographic Inspection, may be performed after Para. 9.7, Particle Impact Noise Detection (PIND) test, in X and Z axes only.
Para. 4.2.3	Para. 9.12, Radiographic Inspection, may be performed in Chart II.