



**TRANSISTORS, SILICON, SWITCHING, PNP,
BASED ON TYPE 2N3467
ESCC Detail Specification No. 5208/009**

**ISSUE 1
October 2002**



	ESCC Detail Specification		PAGE ii ISSUE 1
--	---------------------------	--	--------------------

LEGAL DISCLAIMER AND COPYRIGHT

European Space Agency, Copyright © 2002. All rights reserved.

The European Space Agency disclaims any liability or responsibility, to any person or entity, with respect to any loss or damage caused, or alleged to be caused, directly or indirectly by the use and application of this ESCC publication.

This publication, without the prior permission of the European Space Agency and provided that it is not used for a commercial purpose, may be:

- copied in whole in any medium without alteration or modification.
- copied in part, in any medium, provided that the ESCC document identification, comprising the ESCC symbol, document number and document issue, is removed.



europaean space agency
agence spatiale européenne

Pages 1 to 22

TRANSISTORS, SILICON, SWITCHING, PNP

BASED ON TYPE 2N3467

ESA/SCC Detail Specification No. 5208/009



**space components
coordination group**

Issue/Rev.	Date	Approved by	
		SCCG Chairman	ESA Director General or his Deputy
Issue 1	June 1984		
Revision 'A'	February 1992	<i>Pommes</i>	<i>[Signature]</i>
Revision 'B'	August 1996	<i>San Mill</i>	<i>[Signature]</i>



SCC

ESA/SCC Detail Specification
No. 5208/009

Rev. 'B'

PAGE 2

ISSUE 1

DOCUMENTATION CHANGE NOTICE

Rev. Letter	Rev. Date	Reference	CHANGE Item	Approved DCR No.
'A'	Feb. '92	P1. Cover page P2. DCN P5. Para. 1.2 P11. Para. 2 Para. 4.2.2 Para. 4.2.3 Para. 4.2.4 P18. Table 3	: Paragraph amended : "ESA/SCC Basic Spec. No. 23500" added : Bond Strength and Die Shear Test deviations deleted : PIND deviation deleted : H.T.R.B. deviation deleted : Radiographic Inspection deviation deleted : Bond Strength and Die Shear Test deviations deleted, subsequent deviation renumbered : Reference to Note 2 deleted, Note 1 put under this table	None None 21021 21025 23499 21043 23499 21049 23499 21047
		This document has been transferred from hardcopy to electronic format. The content is unchanged but minor differences in presentation exist.		
'B'	Aug. '96	P1. Cover page P2. DCN P5. Para. 1.7	: Text amended	None None 21083





 	<p style="text-align: center;">ESA/SCC Detail Specification No. 5208/009</p>		<p>PAGE 3 ISSUE 1</p>
---	--	--	---------------------------

TABLE OF CONTENTS

		<u>Page</u>
1.	<u>GENERAL</u>	5
1.1	Scope	5
1.2	Component Type Variants	5
1.3	Maximum Ratings	5
1.4	Parameter Derating Information	5
1.5	Physical Dimensions	5
1.6	Functional Diagram	5
1.7	High Temperature Test Precautions	5
2.	<u>APPLICABLE DOCUMENTS</u>	11
3.	<u>TERMS, DEFINITIONS, ABBREVIATIONS, SYMBOLS AND UNITS</u>	11
4.	<u>REQUIREMENTS</u>	11
4.1	General	11
4.2	Deviations from Generic Specification	11
4.2.1	Deviations from Special In-process Controls	11
4.2.2	Deviations from Final Production Tests (Chart II)	11
4.2.3	Deviations from Burn-in and Electrical Measurements (Chart III)	11
4.2.4	Deviations from Qualification Tests (Chart IV)	11
4.2.5	Deviations from Lot Acceptance Tests (Chart V)	12
4.3	Mechanical Requirements	12
4.3.1	Dimension Check	12
4.3.2	Weight	12
4.3.3	Terminal Strength	12
4.4	Materials and Finishes	12
4.4.1	Case	12
4.4.2	Lead Material and Finish	12
4.5	Marking	12
4.5.1	General	12
4.5.2	Lead Identification	13
4.5.3	The SCC Component Number	13
4.5.4	Traceability Information	13
4.5.5	Marking of Small Components	13

		<p style="text-align: center;">ESA/SCC Detail Specification No. 5208/009</p>	<p>PAGE 4 ISSUE 1</p>
---	---	--	---------------------------

	<u>Page</u>	
4.6	Electrical Measurements	13
4.6.1	Electrical Measurements at Room Temperature	13
4.6.2	Electrical Measurements at High and Low Temperatures	13
4.6.3	Circuits for Electrical Measurements	14
4.7	Burn-in Tests	14
4.7.1	Parameter Drift Values	14
4.7.2	Conditions for High Temperature Reverse Bias and Burn-in	14
4.7.3	Electrical Circuits for Burn-in	14
4.8	Environmental and Endurance Tests	20
4.8.1	Electrical Measurements on Completion of Environmental Tests	20
4.8.2	Electrical Measurements at Intermediate Points during Endurance Tests	20
4.8.3	Electrical Measurements on Completion of Endurance Tests	20
4.8.4	Conditions for Operating Life Tests	20
4.8.5	Electrical Circuits for Operating Life Tests	20
4.8.6	Conditions for High Temperature Storage Test	20

TABLES

1(a)	Type Variants	6
1(b)	Maximum Ratings	7
2	Electrical Measurements at Room Temperature - d.c. Parameters	15
	Electrical Measurements at Room Temperature - a.c. Parameters	16
3	Electrical Measurements at High and Low Temperatures	18
4	Parameter Drift Values	18
5(a)	Conditions for High Temperature Reverse Bias Burn-in	19
5(b)	Conditions for Burn-in and Operating Life Tests	19
6	Electrical Measurements after Environmental Tests and at Intermediate Points and on Completion of Endurance Testing	21

FIGURES

1	Parameter Derating Information	8
2	Physical Dimensions	9
3	Functional Diagram	10
4	Circuits for Electrical Measurements	17

APPENDICES (Applicable to specific Manufacturers only)

'A'	Agreed Deviations for Motorola (F)	22
-----	------------------------------------	----

	<p style="text-align: center;">ESA/SCC Detail Specification No. 5208/009</p>	<p style="text-align: center;">Rev. 'B'</p>	<p>PAGE 5 ISSUE 1</p>
---	--	---	---------------------------

1. GENERAL

1.1 SCOPE

This specification details the ratings, physical and electrical characteristics, test and inspection data for a Transistor, Switching, PNP, based on Type 2N3437. It shall be read in conjunction with ESA/SCC Generic Specification No. 5000, the requirements of which are supplemented herein.

1.2 COMPONENT TYPE VARIANTS

See Table 1(a).

1.3 MAXIMUM RATINGS

The maximum ratings, which shall not be exceeded at any time during use or storage, applicable to the transistors specified herein are scheduled in Table 1(b).

1.4 PARAMETER DERATING INFORMATION

The derating information applicable to the transistors specified herein is shown in Figure 1.

1.5 PHYSICAL DIMENSIONS

The physical dimensions of the transistors specified herein are shown in Figure 2.

1.6 FUNCTIONAL DIAGRAM

The functional diagram showing lead identification, of the transistors specified herein, is shown in Figure 3.

1.7 HIGH TEMPERATURE TEST PRECAUTIONS

For tin-lead plated or solder-dipped lead finish, all tests to be performed at a temperature that exceeds +125°C shall be carried out in a 100% inert atmosphere.

TABLE 1(a) - TYPE VARIANTS

VARIANT	CASE	FIGURE	LEAD MATERIAL AND FINISH
01	TO39	2	D2
02	TO39	2	D3 or D4

TABLE 1(b) - MAXIMUM RATINGS

No.	CHARACTERISTICS	SYMBOL	MAXIMUM RATINGS	UNIT	REMARKS
1	Collector-Emitter Voltage	V_{CE}	- 40	Vdc	
2	Collector-Base Voltage	V_{CB}	- 40	Vdc	
3	Emitter-Base Voltage	V_{EB}	- 5.0	Vdc	
4	Collector Current (Continuous)	I_C	- 1.0	Adc	
5	Power Dissipation (Continuous)	P_{tot}	1.0	W	$T_{amb} \leq +25^{\circ}C$ Note 1
6	Operating Junction Temperature Range	T_{op}	- 65 to + 200	$^{\circ}C$	
7	Storage Temperature Range	T_{stg}	- 65 to + 200	$^{\circ}C$	
8	Soldering Temperature	T_{sol}	+ 265	$^{\circ}C$	Note 2

NOTES

- For derating at $T_{amb} > +25^{\circ}C$, see Figure 1.
- Duration 10 seconds maximum at a distance of not less than 1.5mm from the device body and the same lead shall not be resoldered until 3 minutes have elapsed.

FIGURE 1 - PARAMETER DERATING INFORMATION

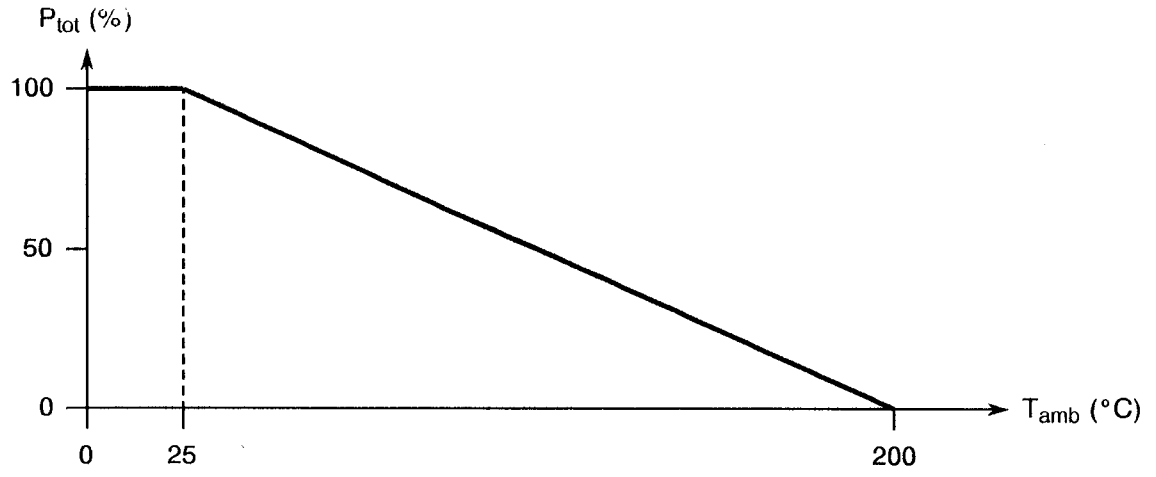

Power Dissipation versus Temperature

FIGURE 2 - PHYSICAL DIMENSIONS

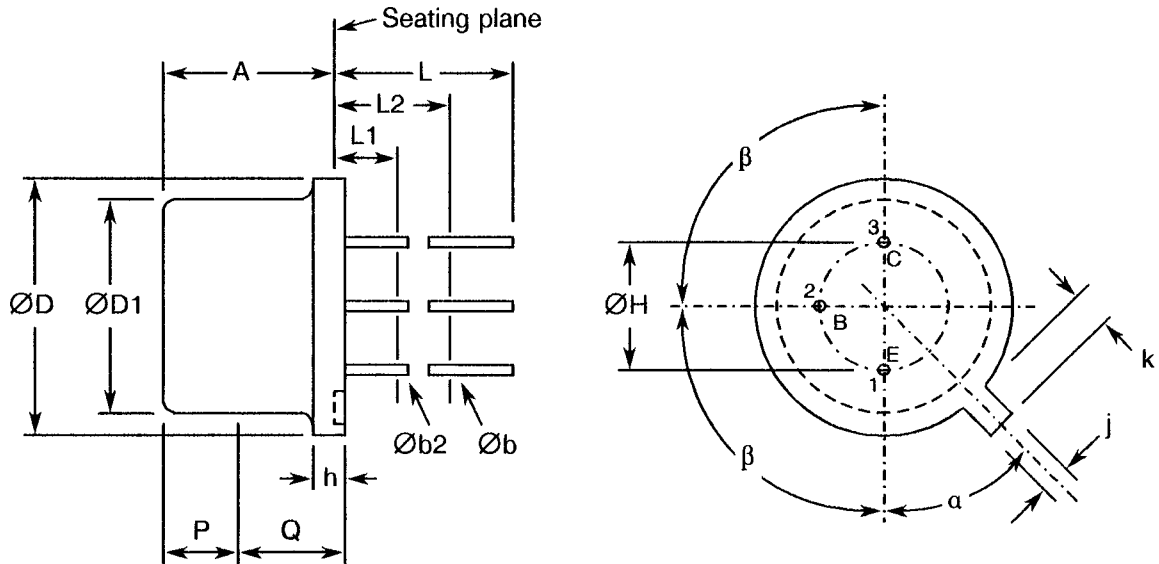

SYMBOL	INCHES		MILLIMETRES		NOTES
	MIN.	MAX.	MIN.	MAX.	
A	0.240	0.260	6.10	6.60	
Øb	0.016	0.021	0.406	0.522	2
Øb2	0.016	0.019	0.406	0.483	2
ØD	0.335	0.370	8.51	9.40	
ØD1	0.305	0.335	7.75	8.51	
ØH	-	0.200	-	5.08	
h	0.009	0.125	0.23	3.18	
j	0.028	0.034	0.71	0.86	
k	0.029	0.045	0.74	1.14	3
L	0.500	-	12.70	-	2
L1	-	0.050	-	1.27	2
L2	0.250	-	6.35	-	2
P	0.100	-	2.54	-	1
Q	-	-	-	-	4
α	45° NOM.		45° NOM.		
β	90° NOM.		90° NOM.		



NOTES: See Page 10.

**FIGURE 2 - PHYSICAL DIMENSIONS (CONTINUED)****NOTES**

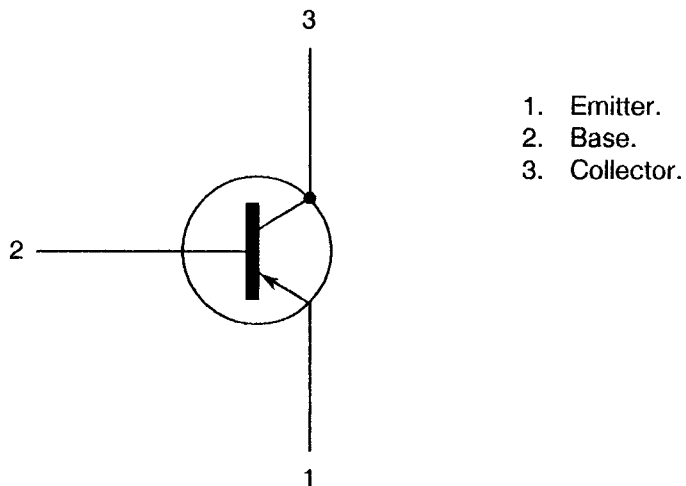
1. This zone is controlled for automatic handling. The variation in actual diameter within this zone shall not exceed 0.010 inches (0.254mm).
2. (3 leads). Dimension $\varnothing b_2$ applies between L1 and L2. Dimension $\varnothing b$ applies between L2 and 0.5 inches (12.7mm) from the seating plane. Diameter is uncontrolled in L1 and beyond 0.5 inches (12.7mm) from the seating plane.
3. Measured from maximum diameter of the actual device.
4. Details of outline in this zone optional.

FIGURE 3 - FUNCTIONAL DIAGRAM**NOTES**

1. The collector is electrically connected to the case.

 	<p style="text-align: center;">ESA/SCC Detail Specification No. 5208/009</p>	<p style="text-align: center;">Rev. 'A'</p>	<p>PAGE 11 ISSUE 1</p>
---	--	---	----------------------------

2. APPLICABLE DOCUMENTS

The following documents form part of this specification and shall be read in conjunction with it:-

- (a) ESA/SCC Generic Specification No. 5000 for Discrete Semiconductor Components.
- (b) MIL-STD-750, Test Methods and Procedures for Semiconductor Devices.
- (c) ESA/SCC Basic Specification No. 23500, Requirements for Lead Materials and Finishes for Components for Space Application.

3. TERMS, DEFINITIONS, ABBREVIATIONS, SYMBOLS AND UNITS

For the purpose of this specification, the terms, definitions, abbreviations, symbols and units specified in ESA/SCC Basic Specification No. 21300 shall apply.

4. REQUIREMENTS

4.1 GENERAL

The complete requirements for procurement of the transistors specified herein are stated in this specification and ESA/SCC Generic Specification No. 5000. Deviations from the Generic Specification, applicable to this specification only, are listed in Para. 4.2.

Deviations from the applicable Generic Specification and this Detail Specification, formally agreed with specific Manufacturers on the basis that the alternative requirements are equivalent to the ESA/SCC requirements and do not affect the components' reliability, are listed in the appendices attached to this specification.

4.2 DEVIATIONS FROM GENERIC SPECIFICATION

4.2.1 Deviations from Special In-process Controls

None.

4.2.2 Deviations from Final Production Tests (Chart II)

None.

4.2.3 Deviations from Burn-in and Electrical Measurements (Chart III)

None.

4.2.4 Deviations from Qualification Tests (Chart IV)

- (a) The electrical measurements specified at the end of Subgroup I and II tests shall be performed as stated in Table 6 of this specification.

	ESA/SCC Detail Specification No. 5208/009	PAGE 12 ISSUE 1
---	--	--------------------

4.2.5 Deviations from Lot Acceptance Tests (Chart V)

None.

4.3 MECHANICAL REQUIREMENTS

4.3.1 Dimension Check

The dimensions of the transistors specified herein shall be checked. They shall conform to those shown in Figure 2.

4.3.2 Weight

The maximum weight of the transistors specified herein shall be 1.2 grammes.

4.3.3 Terminal Strength

The requirements for terminal strength testing are specified in Section 9 of ESA/SCC Generic Specification No. 5000. The test conditions shall be as follows:-

Test Condition: 'E', Lead Fatigue.

Applied Force: 2.5 ± 0.1 Newtons.

4.4 MATERIALS AND FINISHES

The materials and finishes shall be as specified herein. Where a definite material is not specified, a material which will enable the transistors specified herein to meet the performance requirements of this specification shall be used. Acceptance or approval of any constituent material does not guarantee acceptance of the finished product.

4.4.1 Case

Metal case, hermetically sealed, similar to JEDEC TO-39.

4.4.2 Lead Material and Finish

The lead material shall be Type 'D' with either Type '2' or Type '3 or 4' finish in accordance with the requirements of ESA/SCC Basic Specification No. 23500. (See Table 1(a) for Type Variants).

4.5 MARKING

4.5.1 General

The marking of all components delivered to this specification shall be in accordance with the requirements of ESA/SCC Basic Specification No. 21700. Each component shall be marked in respect of:-

- (a) Lead Identification.
- (b) The SCC Component Number.
- (c) Traceability Information.

4.5.2 Lead Identification

Lead identification shall be as shown in Figures 2 and 3.

4.5.3 The SCC Component Number

Each component shall bear the SCC Component Number which shall be constituted and marked as follows:-

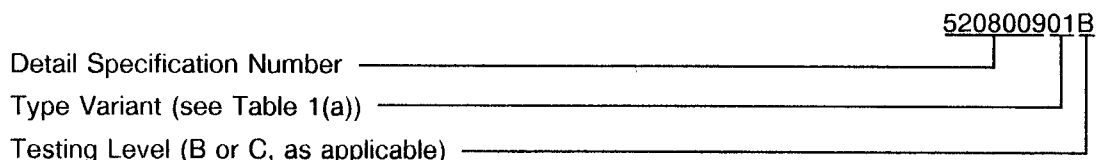

4.5.4 Traceability Information

Each component shall be marked in respect of traceability information in accordance with the requirements of ESA/SCC Basic Specification No. 21700.

4.5.5 Marking of Small Components

When it is considered that the component is too small to accommodate the marking as specified above, as much as space permits shall be marked. The order of precedence shall be as follows:-

- (a) Lead Identification.
- (b) The SCC Component Number.
- (c) Traceability Information.

The marking information in full shall accompany each component in its primary package.

4.6 ELECTRICAL MEASUREMENTS

4.6.1 Electrical Measurements at Room Temperature

The parameters to be measured at room temperature are scheduled in Table 2. Unless otherwise specified, measurements shall be performed at $T_{amb} = +25 \pm 3$ °C.

4.6.2 Electrical Measurements at High and Low Temperatures

The parameters to be measured at high and low temperatures are scheduled in Table 3.



4.6.3 Circuits for Electrical Measurements

Circuits for use in performing the electrical measurements listed in Tables 2 and 3 of this specification are shown in Figure 4.

4.7 BURN-IN TESTS

4.7.1 Parameter Drift Values

The parameter drift values applicable to burn-in are specified in Table 4 of this specification. Unless otherwise stated, measurements shall be performed at $T_{amb} = +25 \pm 3$ °C. The parameter drift values (Δ) applicable to the parameters scheduled shall not be exceeded. In addition to these drift value requirements, the appropriate limit value specified for a given parameter in Table 2 shall not be exceeded.

4.7.2 Conditions for High Temperature Reverse Bias and Burn-in

The requirements for high temperature reverse bias and burn-in are specified in Section 7 of ESA/SCC Generic Specification No. 5000. The conditions for high temperature reverse bias and burn-in are specified in Tables 5(a) and 5(b) of this specification.

4.7.3 Electrical Circuits for Burn-in

Not applicable.

TABLE 2 - ELECTRICAL MEASUREMENTS AT ROOM TEMPERATURE - d.c. PARAMETERS

No.	CHARACTERISTICS	SYMBOL	MIL-STD-750 TEST METHOD	TEST CONDITIONS	LIMITS		UNIT
					MIN	MAX	
1	Collector-Base Breakdown Voltage	BV_{CBO}	3001 Bias Cond. D	$I_C = -10\mu A$ $I_B = 0A$	-40	-	V
2	Collector-Emitter Breakdown Voltage	BV_{CEO}	3011 Bias Cond. D	$I_C = -10mA$ $I_E = 0A$ Note 1	-40	-	V
3	Emitter-Base Breakdown Voltage	BV_{EBO}	3066	$I_E = -10\mu A$ $I_B = 0A$	-5.0	-	V
4	Collector-Emitter Cut-off Current	I_{CEX}	3041 Bias Cond. A	$V_{BE} = -3.0V$ $V_{CE} = -30V$	-	-100	nA
5	Collector-Base Cut-off Current	I_{CBO}	3036 Bias Cond. D	$V_{CB} = -30V$ $I_E = 0A$	-	-100	nA
6	D.C. Forward Current Transfer Ratio 1	h_{FE1}	3076	$V_{CE} = -1.0V$ $I_C = -150mA$, Note 1	40	-	-
7	D.C. Forward Current Transfer Ratio 2	h_{FE2}	3076	$V_{CE} = -1.0V$ $I_C = -500mA$, Note 1	40	120	-
8	D.C. Forward Current Transfer Ratio 3	h_{FE3}	3076	$V_{CE} = -5.0V$ $I_C = -1.0A$, Note 1	40	-	-
9	Collector-Emitter Saturation Voltage 1	$V_{CE(SAT)1}$	3071	$I_C = -150mA$ $I_B = -15mA$, Note 1	-	-0.35	V
10	Collector-Emitter Saturation Voltage 2	$V_{CE(SAT)2}$	3071	$I_C = -500mA$ $I_B = -50mA$, Note 1	-	-0.6	V
11	Collector-Emitter Saturation Voltage 3	$V_{CE(SAT)3}$	3071	$I_C = -1.0mA$ $I_B = -100mA$, Note 1	-	-1.2	V
12	Base-Emitter Saturation Voltage 1	$V_{BE(SAT)1}$	3066 Bias Cond. A	$I_C = -150mA$ $I_B = -15mA$, Note 1	-	-1.0	V
13	Base-Emitter Saturation Voltage 2	$V_{BE(SAT)2}$	3066 Bias Cond. A	$I_C = -500mA$ $I_B = -50mA$, Note 1	-	-1.2	V
14	Base-Emitter Saturation Voltage 3	$V_{BE(SAT)3}$	3066 Bias Cond. A	$I_C = -1.0A$ $I_B = -100mA$, Note 1	-	-1.6	V

NOTES: See Page 16.

TABLE 2 - ELECTRICAL MEASUREMENTS AT ROOM TEMPERATURE - a.c. PARAMETERS

No.	CHARACTERISTICS	SYMBOL	MIL-STD-750 TEST METHOD	TEST FIG.	TEST CONDITIONS (NOTE 2)	LIMITS		UNIT
						MIN	MAX	
15	A.C. Forward Current Transfer Ratio	h_{fe}	3306	-	$I_C = -50mA$ $V_{CE} = -10V$ $f = 100MHz$	1.8	-	-
16	Output Capacitance	C_{ob}	3236	-	$V_{CB} = -10V$ $I_E = 0A$ $f = 100kHz$	-	25	pF
17	Input Capacitance	C_{ib}	3240	-	$V_{EB} = -0.5V$ $I_C = 0A$ $f = 100kHz$	-	100	pF
18	Delay Time	t_d	-	4(a)	$I_C = -500mA$ $I_{B1} = -50mA$ $V_{BE} = -2.0V$ $V_{CE} = -30V$	-	10	ns
19	Rise Time	t_r	-	4(a)	$I_C = -500mA$ $I_{B1} = -50mA$ $V_{BE} = -2.0V$ $V_{CE} = -30V$	-	30	ns
20	Storage Time	t_s	-	4(b)	$I_C = -500mA$ $I_{B1} = I_{B2} = -50mA$ $V_{CC} = -30V$	-	60	ns
21	Fall Time	t_f	-	4(b)	$I_C = -500mA$ $I_{B1} = I_{B2} = -50mA$ $V_{CC} = -30V$	-	30	ns

NOTES

1. Pulsed measurement: Pulse Width $\leq 2.0\mu s$, Duty Cycle $\leq 1.0\%$.
2. Measurements shall be performed on a sample basis, LTPD7 or less.



FIGURE 4 - CIRCUITS FOR ELECTRICAL MEASUREMENTS

FIGURE 4(a) - DELAY AND RISE TIMES

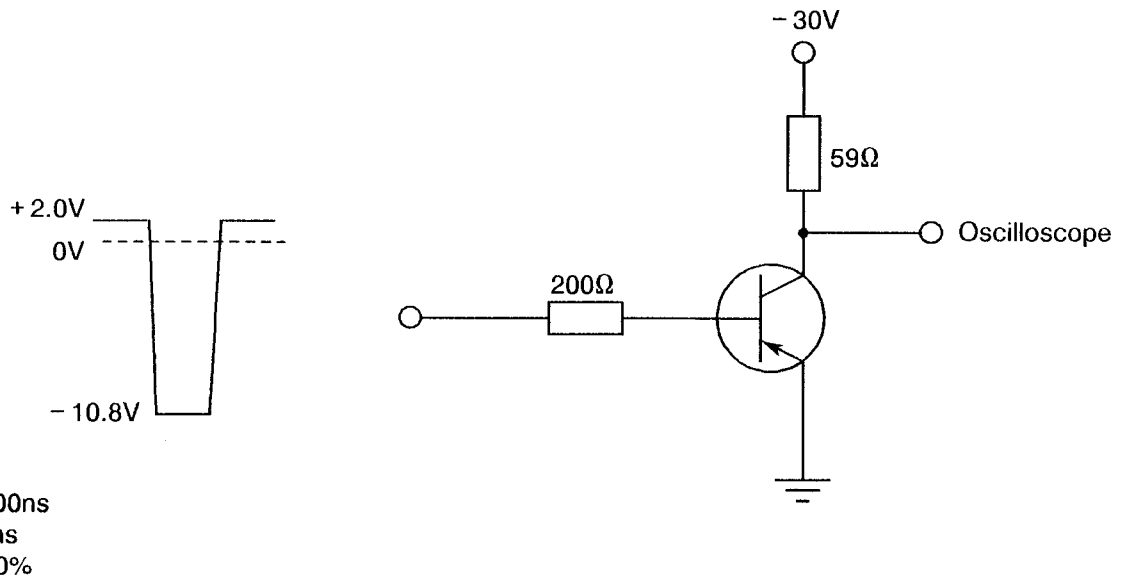
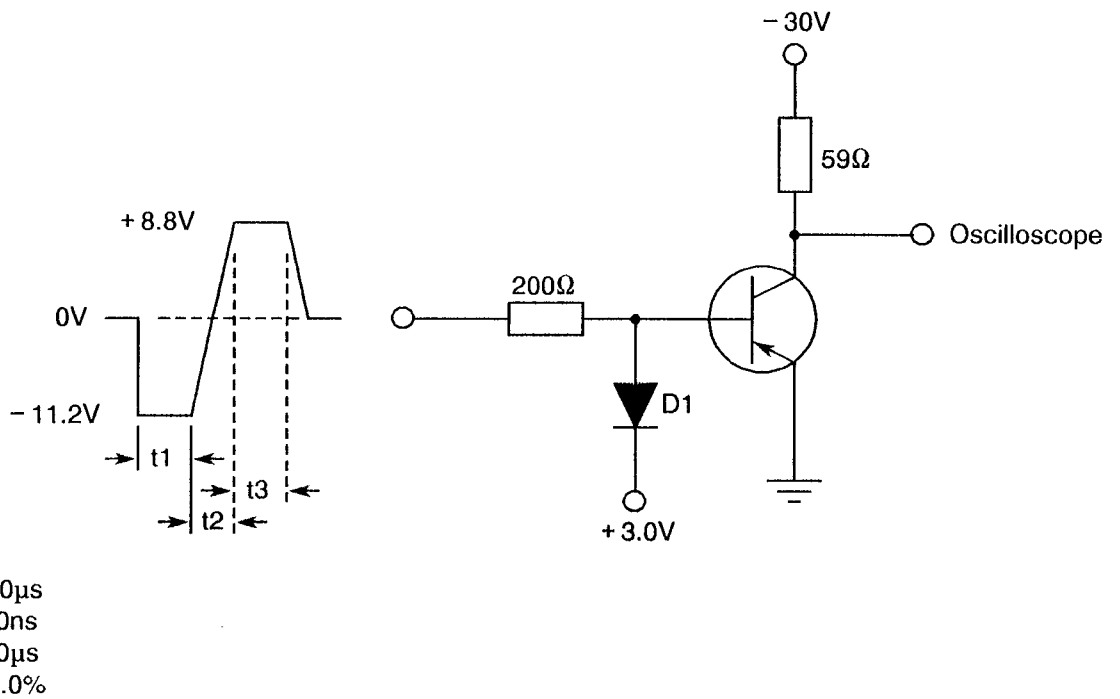

FIGURE 4(b) - STORAGE AND FALL TIMES



NOTES

1. D1 similar to 1N914 or equivalent.

TABLE 3 - ELECTRICAL MEASUREMENTS AT HIGH AND LOW TEMPERATURES

No.	CHARACTERISTICS	SYMBOL	MIL-STD-750 TEST METHOD	TEST CONDITIONS	LIMITS		UNIT
					MIN	MAX	
5	Collector-Base Cut-off Current	I_{CBO}	3036 Bias Cond. D	$T_{case} = +150^{\circ}C$ $V_{CB} = -30V$ $I_E = 0A$	-	-50	μA
6	D.C. Forward Current Transfer Ratio 1	h_{FE1}	3076	$T_{amb} = -55^{\circ}C$ $I_C = -150mA$ $V_{CE} = -1.0V$ Note 1	16	-	-

NOTES

1. Pulsed measurement: Pulse Width $\leq 2.0\mu s$, Duty Cycle $\leq 1.0\%$.

TABLE 4 - PARAMETER DRIFT VALUES

No.	CHARACTERISTICS	SYMBOL	SPEC. AND/OR TEST METHOD	TEST CONDITIONS	CHANGE LIMITS (Δ)	UNIT
5	Collector-Base Cut-off Current	I_{CBO}	As per Table 2	As per Table 2	± 30 or (1) ± 100	nA %
7	D.C. Forward Current Transfer Ratio 2	h_{FE2}	As per Table 2	As per Table 2	± 15	%
9	Collector-Emitter Saturation Voltage 1	$V_{CE(SAT)1}$	As per Table 2	As per Table 2	± 50 or (1) ± 15	mV %

NOTES

1. Whichever is greater, referred to the initial value.

TABLE 5(a) - CONDITIONS FOR HIGH TEMPERATURE REVERSE BIAS BURN-IN

No.	CHARACTERISTICS	SYMBOL	CONDITIONS	UNIT
1	Ambient Temperature	T_{amb}	+ 150	°C
2	Collector-Base Voltage	V_{CB}	- 30	V
3	Duration	t	48	Hrs

TABLE 5(b) - CONDITIONS FOR BURN-IN AND OPERATING LIFE TESTS

No.	CHARACTERISTICS	SYMBOL	CONDITIONS	UNIT
1	Ambient Temperature	T_{amb}	+ 25	°C
2	Collector-Base Voltage	V_{CB}	- 30	V
3	Power Dissipation	P_{tot}	1.0	W



- 4.8 ENVIRONMENTAL AND ENDURANCE TESTS (CHARTS IV AND V OF ESA/SCC GENERIC SPECIFICATION NO. 5000)
- 4.8.1 Electrical Measurements on Completion of Environmental Tests
The parameters to be measured on completion of environmental tests are scheduled in Table 6. The measurements shall be performed at $T_{amb} = +25 \pm 3 \text{ }^\circ\text{C}$.
- 4.8.2 Electrical Measurements at Intermediate Points during Endurance Tests
The parameters to be measured at intermediate points during endurance tests are scheduled in Table 6 of this specification.
- 4.8.3 Electrical Measurements on Completion of Endurance Tests
The parameters to be measured on completion of endurance testing are scheduled in Table 6 of this specification. The measurements shall be performed at $T_{amb} = +25 \pm 3 \text{ }^\circ\text{C}$.
- 4.8.4 Conditions for Operating Life Tests (Part of Endurance Testing)
The requirements for operating life testing are specified in Section 9 of ESA/SCC Generic Specification No. 5000. The conditions for operating life testing shall be the same as specified in Table 5(b) for the burn-in test.
- 4.8.5 Electrical Circuits for Operating Life Tests
Not applicable.
- 4.8.6 Conditions for High Temperature Storage Test (Part of Endurance Testing)
The requirements for the high temperature storage test are specified in ESA/SCC Generic Specification No. 5000. The conditions for high temperature storage shall be $T_{amb} = +200(+0 - 5) \text{ }^\circ\text{C}$

TABLE 6 - ELECTRICAL MEASUREMENTS AFTER ENVIRONMENTAL TESTS AND AT INTERMEDIATE POINTS AND ON COMPLETION OF ENDURANCE TESTING

No.	CHARACTERISTICS	SYMBOL	SPEC. AND/OR TEST METHOD	TEST CONDITIONS	LIMITS		UNIT
					MIN.	MAX.	
5	Collector-Base Cut-off Current	I_{CBO}	As per Table 2	As per Table 2	-	- 100	nA
7	D.C. Forward Current Transfer Ratio 2	h_{FE2}	As per Table 2	As per Table 2	40	120	-
10	Collector-Emitter Saturation Voltage 2	$V_{CE(SAT)2}$	As per Table 2	As per Table 2	-	- 0.6	V

	<p>ESA/SCC Detail Specification No. 5208/009</p>		<p>PAGE 22 ISSUE 1</p>
---	--	--	----------------------------

APPENDIX 'A'

Page 1 of 1

AGREED DEVIATIONS FOR MOTOROLA (F)

ITEMS AFFECTED	DESCRIPTION OF DEVIATIONS
Para. 4.2.2	<p>Deviations from Final Production Tests (Chart II)</p> <p>(a) Para. 9.1, Internal Visual Inspection: Shall be performed in accordance with Motorola Specification 12 MRT 03700A Issue E.</p>