



**TRANSISTORS, LOW POWER, PNP,
BASED ON TYPE 2N2907A
ESCC Detail Specification No. 5202/001**

**ISSUE 1
October 2002**



	ESCC Detail Specification		PAGE ii ISSUE 1
---	---------------------------	--	--------------------

LEGAL DISCLAIMER AND COPYRIGHT

European Space Agency, Copyright © 2002. All rights reserved.

The European Space Agency disclaims any liability or responsibility, to any person or entity, with respect to any loss or damage caused, or alleged to be caused, directly or indirectly by the use and application of this ESCC publication.

This publication, without the prior permission of the European Space Agency and provided that it is not used for a commercial purpose, may be:

- copied in whole in any medium without alteration or modification.
- copied in part, in any medium, provided that the ESCC document identification, comprising the ESCC symbol, document number and document issue, is removed.



european space agency
agence spatiale européenne

Pages 1 to 20

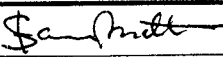

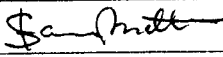
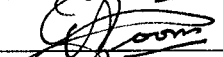
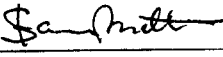
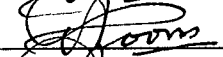
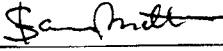
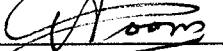
TRANSISTORS, LOW POWER, PNP,

BASED ON TYPE 2N2907A

ESA/SCC Detail Specification No. 5202/001



**space components
coordination group**

Issue/Rev.	Date	Approved by	
		SCCG Chairman	ESA Director General or his Deputy
Issue 6	August 1996		
Revision 'A'	December 1996		
Revision 'B'	April 1997		
Revision 'C'	June 1999		

**DOCUMENTATION CHANGE NOTICE**

Rev. Letter	Rev. Date	Reference	CHANGE Item	Approved DCR No.
		This Issue supersedes Issue 5 and incorporates all modifications defined in Revisions 'A' and 'B' to Issue 5 and the changes agreed in the following DCR's:-		
		Cover page		None
		DCN		None
		Para. 1.2	: Existing text deleted and new text added	221358
		Para. 2	: Item (c) deleted	221358
		Table 1(a)	: Lead Material column heading amended	221358
			: Figure numbers amended	221358
			: Variant 04 added	221358
		Table 1(b)	: No. 4, Variant references added to Characteristics	221358
			: No. 5, Variant references added to Characteristics	221358
			, New Maximum Rating added	221358
			, Note reference amended to "2" in Remarks	221358
			: No. 6, Variant references added to Characteristics	221358
			, Note reference amended to "2" in Remarks	221358
			: No. 7, Symbol amended to "T _{op} " and "T _{amb} " added to Remarks	221358
			: No. 9, Variant references added to Characteristics	221358
			, "+ 245" added to Maximum Ratings	221358
			, Existing Remarks deleted and Note references added	221358
			: NOTES, Note 1 amended and renumbered as "2"	221358
			, New Notes 1, 3 and 4 added	221358
		Figure 2	: Existing Figure Titled as Figure 2(a)	221358
			: Imperial Dimensions deleted from Table and Notes	221358
			: Notes and Note references renumbered	221358
		Figure 2(b)	: New Figure added	221358
		Figure 3	: Note amended	221358
		Para. 4.3.2	: Text amended	221358
		Para. 4.3.3	: Second sentence amended	221358
			: Applied Force deleted	221332
		Para. 4.4.1	: Existing text amended and new text added	221358
		Para. 4.4.2	: Existing text amended and new text added	221358
		Para. 4.5.1	: Existing text deleted and new text added	221358
		Para. 4.5.5	: Deleted in toto	221358
		Para. 4.7.2	: New paragraph added	221358
			: Existing paragraph renumbered to "4.7.3" and second sentence amended	221358
		Para. 4.7.3	: Renumbered as "4.7.5" and text amended	221358
		Para. 4.7.4	: Title and text amended	221358
		Table 5	: Main heading deleted and Tables reversed in sequence	221358
			: New Titles added	221358
		Table 5(b)	: No. 2, "1" added to Characteristics and Symbol	221358
			, "Note 1" added to Conditions	221358
			: Note 1 added	221358
		Figure 5	: Main heading deleted and existing Titles amended	221358
		Para. 4.8.1	: Second sentence expanded	221358
		Para. 4.8.2	: Second sentence added	221358
		Paras 4.8.3 and 4.8.4	: In the text, "5" amended to "5(b)"	221358

**TABLE OF CONTENTS**

	<u>Page</u>
1. <u>GENERAL</u>	5
1.1 Scope	5
1.2 Component Type Variants	5
1.3 Maximum Ratings	5
1.4 Parameter Derating Information	5
1.5 Physical Dimensions	5
1.6 Functional Diagram	5
1.7 High Temperature Test Precautions	5
2. <u>APPLICABLE DOCUMENTS</u>	5
3. <u>TERMS, DEFINITIONS, ABBREVIATIONS, SYMBOLS AND UNITS</u>	5
4. <u>REQUIREMENTS</u>	10
4.1 General	10
4.2 Deviations from Generic Specification	10
4.2.1 Deviations from Special In-process Controls	10
4.2.2 Deviations from Final Production Tests	10
4.2.3 Deviations from Burn-in and Electrical Measurements	10
4.2.4 Deviations from Qualification Tests	10
4.2.5 Deviations from Lot Acceptance Tests	10
4.3 Mechanical Requirements	10
4.3.1 Dimension Check	10
4.3.2 Weight	10
4.3.3 Terminal Strength	10
4.4 Materials and Finishes	11
4.4.1 Case	11
4.4.2 Lead Material and Finish	11
4.5 Marking	11
4.5.1 General	11
4.5.2 Lead Identification	11
4.5.3 The SCC Component Number	11
4.5.4 Traceability Information	11
4.6 Electrical Measurements	12
4.6.1 Electrical Measurements at Room Temperature	12
4.6.2 Electrical Measurements at High and Low Temperatures	12
4.6.3 Circuits for Electrical Measurements	12
4.7 Burn-in Tests	12
4.7.1 Parameter Drift Values	12
4.7.2 Conditions for High Temperature Reverse Bias Burn-in	12
4.7.3 Conditions for Power Burn-in	12
4.7.4 Electrical Circuits for High Temperature Reverse Bias Burn-in	12
4.7.5 Electrical Circuits for Power Burn-in	12
4.8 Environmental and Endurance Tests	18
4.8.1 Electrical Measurements on Completion of Environmental Tests	18
4.8.2 Electrical Measurements at Intermediate Points and on Completion of Endurance Tests	18
4.8.3 Conditions for Operating Life Tests	18
4.8.4 Electrical Circuits for Operating Life Tests	18
4.8.5 Conditions for High Temperature Storage Test	18

**SCC**ESA/SCC Detail Specification
No. 5202/001

Rev. 'B'

PAGE 4

ISSUE 6

TABLES

	<u>Page</u>
1(a) Type Variants	6
1(b) Maximum Ratings	6
2 Electrical Measurements at Room Temperature - d.c. Parameters	13
Electrical Measurements at Room Temperature - a.c. Parameters	14
3 Electrical Measurements at High and Low Temperatures	14
4 Parameter Drift Values	16
5(a) Conditions for High Temperature Reverse Bias Burn-in	17
5(b) Conditions for Power Burn-in and Operating Life Tests	17
6 Electrical Measurements at Intermediate Points and on Completion of Endurance Testing	19

FIGURES

1 Parameter Derating Information	7
2 Physical Dimensions	8
3 Functional Diagram	9
4 Circuits for Electrical Measurements	15
5(a) Electrical Circuit for High Temperature Reverse Bias Burn-in	17
5(b) Electrical Circuit for Power Burn-in and Operating Life Tests	17

APPENDICES (Applicable to specific Manufacturers only)

'A' Agreed Deviations for SGS-Thomson (F)	20
---	----

**1. GENERAL****1.1 SCOPE**

This specification details the ratings, physical and electrical characteristics, test and inspection data for a Transistor, Low Power, PNP, based on Type 2N2907A. It shall be read in conjunction with ESA/SCC Generic Specification No.5000, the requirements of which are supplemented herein.

1.2 COMPONENT TYPE VARIANTS

Variants of the basic transistors specified herein, which are also covered by this specification, are given in Table 1(a).

1.3 MAXIMUM RATINGS

The maximum ratings, which shall not be exceeded at any time during use or storage, applicable to the transistors specified herein, are scheduled in Table 1(b).

1.4 PARAMETER DERATING INFORMATION

The derating information applicable to the transistors specified herein is shown in Figure 1.

1.5 PHYSICAL DIMENSIONS

The physical dimensions of the transistors specified herein are shown in Figure 2.

1.6 FUNCTIONAL DIAGRAM

The functional diagram, showing lead identification, of the transistors specified herein, is shown in Figure 3.

1.7 HIGH TEMPERATURE TEST PRECAUTIONS

For tin-lead plated or solder-dipped lead finish, all tests to be performed at a temperature that exceeds + 125°C shall be carried out in 100% inert atmosphere.

2. APPLICABLE DOCUMENTS

The following documents form part of this specification and shall be read in conjunction with it:-

- (a) ESA/SCC Generic Specification No. 5000 for Discrete Semiconductors.
- (b) MIL-STD-750, Test Methods and Procedures for Semiconductor Devices.

3. TERMS, DEFINITIONS, ABBREVIATIONS, SYMBOLS AND UNITS

For the purpose of this specification, the terms, definitions, abbreviations, symbols and units specified in ESA/SCC Basic Specification No. 21300 shall apply.

TABLE 1(a) - TYPE VARIANTS

VARIANT	BASED ON TYPE	CASE	FIGURE	LEAD MATERIAL AND/OR FINISH
01	2N2907A	TO18	2(a)	D2
02	2N2907A	TO18	2(a)	D3 or D4
03	2N2907A	TO18	2(a)	D7
04	2N2907A	CHIP CARRIER	2(b)	2
05	2N2907A	CHIP CARRIER	2(b)	4

TABLE 1(b) - MAXIMUM RATINGS

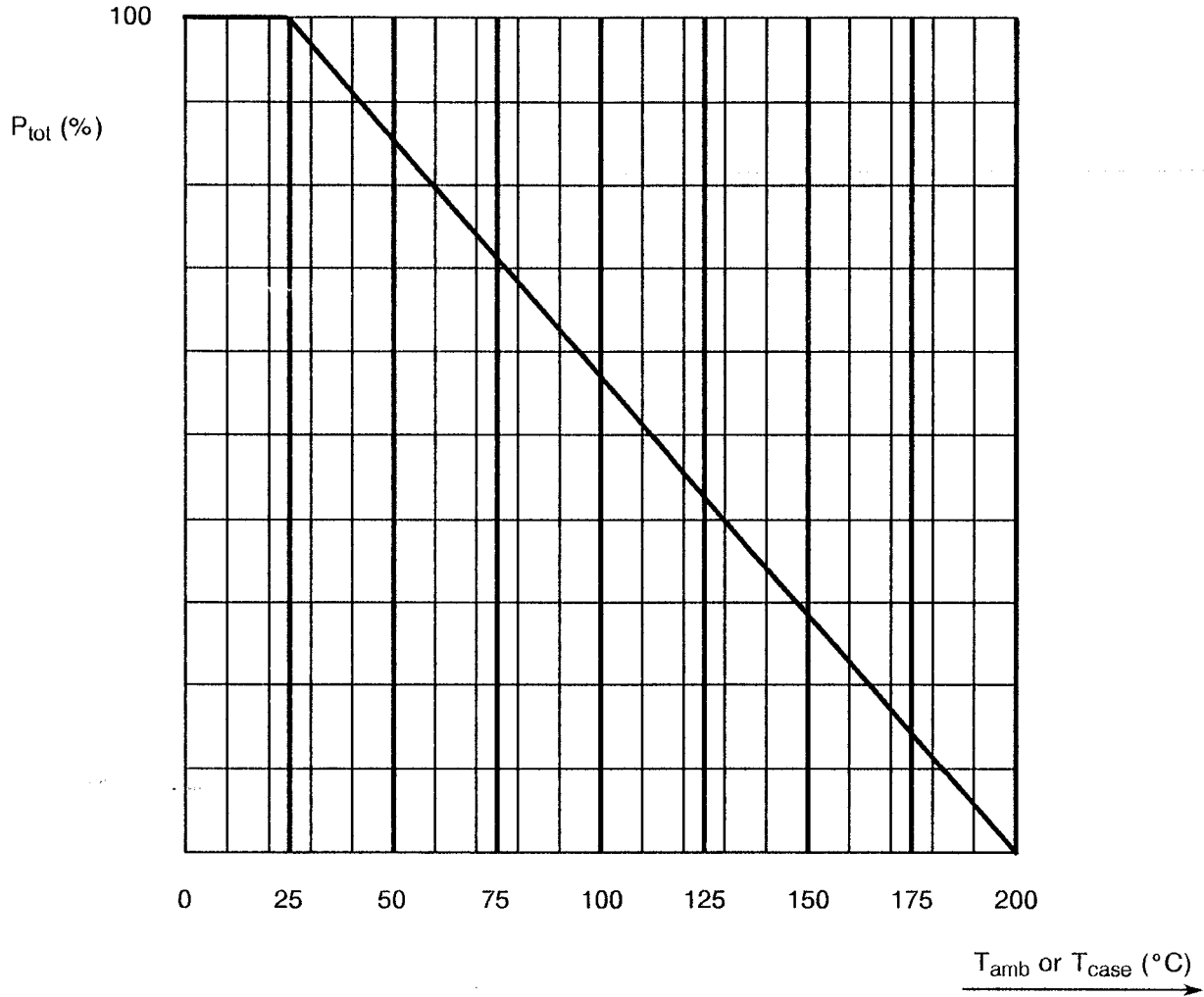
No.	CHARACTERISTICS	SYMBOL	MAXIMUM RATING	UNIT	REMARKS
1	Collector-Base Voltage	V_{CBO}	- 60	V	
2	Collector-Emitter Voltage	V_{CEO}	- 60	V	
3	Emitter-Base Voltage	V_{EBO}	- 5.0	V	
4	Collector Current (Continuous) Variants 01 to 03 Variants 04 and 05	I_C	- 0.6 - 0.5	A	
5	Power Dissipation 1 All Variants Variants 04 and 05	P_{tot1}	0.4 0.73 (1)	W	At $T_{amb} \leq +25^\circ\text{C}$ Note 2
6	Power Dissipation 2 Variants 01 to 03	P_{tot2}	1.8	W	At $T_{case} \leq +25^\circ\text{C}$ Note 2
7	Operating Temperature Range	T_{op}	- 65 to + 200	$^\circ\text{C}$	T_{amb}
8	Storage Temperature Range	T_{stg}	- 65 to + 200	$^\circ\text{C}$	
9	Soldering Temperature Variants 01 to 03 Variants 04 and 05	T_{sol}	+ 260 + 245	$^\circ\text{C}$	Note 3 Note 4

NOTES

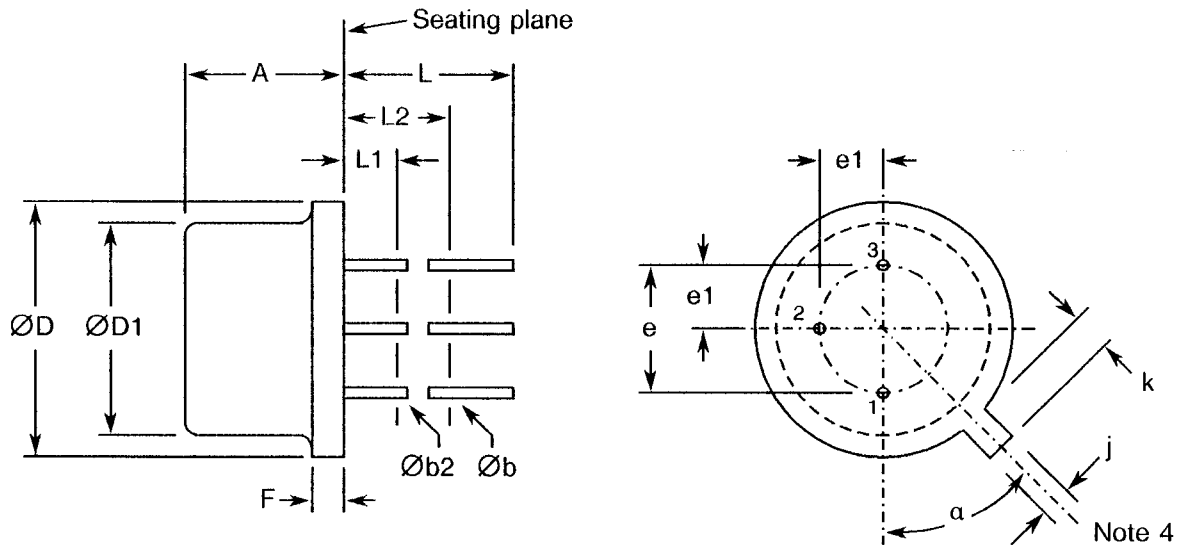
- When mounted on a 15×15×0.6mm ceramic substrate.
- For derating at T_{amb} or $T_{case} > +25^\circ\text{C}$, see Figure 1.
- Duration 10 seconds maximum at a distance of not less than 1.5mm from the device body and the same lead shall not be resoldered until 3 minutes have elapsed.
- Duration 5 seconds maximum and the same terminal shall not be resoldered until 3 minutes have elapsed.



FIGURE 1 - PARAMETER DERATING INFORMATION



Power Dissipation versus Temperature

**FIGURE 2 - PHYSICAL DIMENSIONS****FIGURE 2(a) - VARIANTS 01 TO 03**

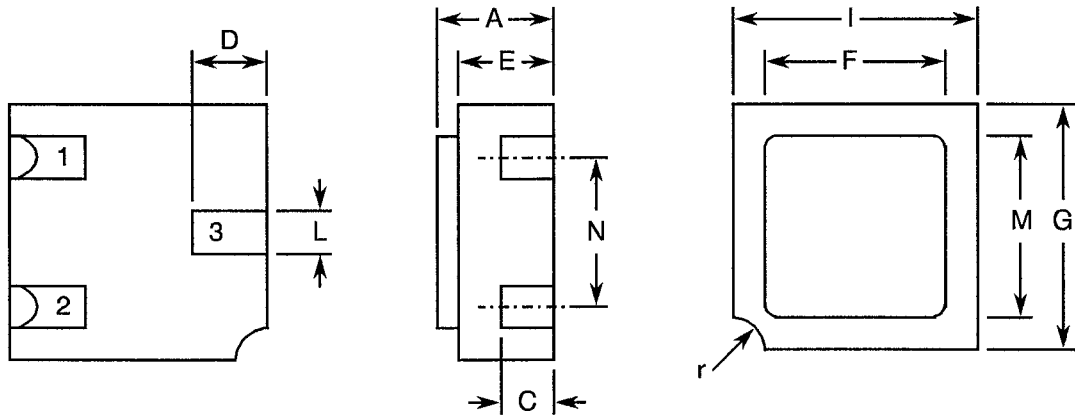
SYMBOL	MILLIMETRES		NOTES
	MIN.	MAX	
A	4.32	5.33	
Øb	0.406	0.533	1
Øb2	0.406	0.483	1
ØD	5.31	5.84	
ØD1	4.52	4.95	
e	2.54 TYP.		2
e1	1.27 TYP.		2
F	-	0.762	
j	0.914	1.17	
k	0.711	1.22	3
L	12.70	-	1
L1	-	1.27	1
L2	6.35	-	1
a	45° TYP.		4

NOTES

1. (Three leads) Øb2 applies between L1 and L2. Øb applies between L2 and 12.70mm from the seating plane. Diameter is uncontrolled in L1 and beyond 12.70mm from the seating plane.
2. Leads having maximum diameter 0.483mm measured in the gauging plane 1.37mm + 0.025mm - 0.00mm below the seating plane of the device shall be within 0.178mm of their true position relative to a maximum-width-tab.
3. Measured from maximum diameter of the actual device.
4. Tab centreline.

FIGURE 2 - PHYSICAL DIMENSIONS (CONTINUED)

FIGURE 2(b) - VARIANTS 04 AND 05

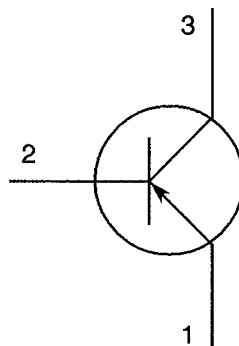


SYMBOL	MILLIMETRES		NOTES
	MIN.	MAX.	
A	1.15	1.50	
C	0.45	0.56	1
D	0.60	0.91	1
E	0.91	1.12	
F	1.90	2.15	
G	2.90	3.25	
I	2.40	2.85	
L	0.40	0.60	1
M	2.40	2.65	
N	1.80	2.00	
r	0.3 TYP.		

NOTES

1. The three pads have the same dimensions.



FIGURE 3 - FUNCTIONAL DIAGRAM



1. Emitter.
2. Base.
3. Collector.

NOTES

1. For Variants 01 to 03, the collector is internally connected to the case.

 	<p style="text-align: center;">ESA/SCC Detail Specification No. 5202/001</p>	<p style="text-align: center;">Rev. 'C'</p>	<p style="text-align: right;">PAGE 10 ISSUE 6</p>
---	--	---	---

4. REQUIREMENTS

4.1 GENERAL

The complete requirements for procurement of the transistors specified herein shall be as stated in this specification and ESA/SCC Generic Specification No. 5000 for Discrete Semiconductors. Deviations from the Generic Specification, applicable to this specification only, are listed in Para. 4.2.

Deviations from the applicable Generic Specification and this Detail Specification, formally agreed with specific Manufacturers on the basis that the alternative requirements are equivalent to the ESA/SCC requirements and do not affect the components' reliability, are listed in the appendices attached to this specification.

4.2 DEVIATIONS FROM GENERIC SPECIFICATION

4.2.1 Deviations from Special In-process Controls

None.

4.2.2 Deviations from Final Production Tests (Chart II)

None.

4.2.3 Deviations from Burn-in and Electrical Measurements (Chart III)

None.

4.2.4 Deviations from Qualification Tests (Chart IV)

None.

4.2.5 Deviations from Lot Acceptance Tests (Chart V)

None.

4.2.5 Deviations from Lot Acceptance Tests (Chart V)

None.

4.3 MECHANICAL REQUIREMENTS

4.3.1 Dimension Check

The dimensions of the transistors specified herein shall be checked. They shall conform to those shown in Figure 2.



4.3.2 Weight

The maximum weight of the transistors specified herein shall be 0.4 grammes for Variants 01 to 03 and 0.06 grammes for Variants 04 and 05.

4.3.3 Terminal Strength

The requirements for terminal strength testing are specified in Section 9 of ESA/SCC Generic Specification No. 5000. For Variants 01 to 03, the test conditions shall be as follows:-

Test Condition: 'E', Lead Fatigue.

		ESA/SCC Detail Specification No. 5202/001	Rev. 'C'	PAGE 11 ISSUE 6
---	---	--	----------	--------------------

4.4 MATERIALS AND FINISHES

The materials and finishes shall be as specified herein. Where a definite material is not specified, a material which will enable the transistors specified herein to meet the performance requirements of this specification shall be used. Acceptance or approval of any constituent material does not guarantee acceptance of the finished product.

4.4.1 Case

For Variants 01 to 03, the case shall be hermetically sealed and have a metal body with hard glass seals and the lid shall be welded, brazed, preform soldered or glass frit sealed.

For Variants 04 and 05, the case shall be hermetically sealed and have a ceramic body with a kovar lid.

4.4.2 Lead Material and Finish

For Variants 01 to 03, the lead material shall be Type 'D' with either Type '2', Type '3 or 4' or Type '7' finish in accordance with the requirements of ESA/SCC Basic Specification No. 23500. (See Table 1(a) for Type Variants).

For Variants 04 and 05, the terminal finish shall be either Type '2' or Type '4' in accordance with the requirements of ESA/SCC Basic Specification No. 23500. (See Table 1(a) for Type Variants).

4.5 MARKING

4.5.1 General

The marking of all components delivered to this specification shall be in accordance with the requirements of ESA/SCC Basic Specification No. 21700 and the following paragraphs. When the component is too small to accommodate all of the marking specified, as much as space permits shall be marked and the marking information, in full, shall accompany the component in its primary package.

The information to be marked and the order of precedence, shall be as follows:-

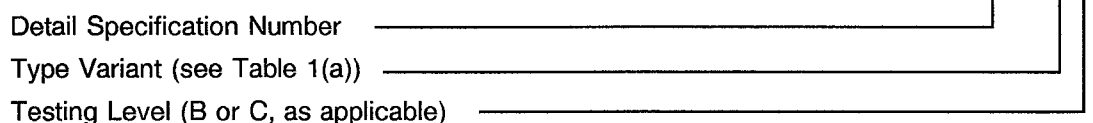
- (a) Lead Identification.
- (b) The SCC Component Number.
- (c) Traceability Information.

4.5.2 Lead Identification

Lead identification shall be as shown in Figures 2 and 3.

4.5.3 The SCC Component Number

Each component shall bear the SCC Component Number which shall be constituted and marked



4.5.4 Traceability Information

Each component shall be marked in respect of traceability information in accordance with the requirements of ESA/SCC Basic Specification No. 21700.



4.6 ELECTRICAL MEASUREMENTS

4.6.1 Electrical Measurements at Room Temperature

The parameters to be measured at room temperature are scheduled in Table 2. Unless otherwise specified, the measurements shall be performed at $T_{amb} = +22 \pm 3$ °C.

4.6.2 Electrical Measurements at High and Low Temperatures

The parameters to be measured at high and low temperatures are scheduled in Table 3.

4.6.3 Circuits for Electrical Measurements

Circuits for use in performing the electrical measurements listed in Tables 2 and 3 of this specification are shown in Figure 4.

4.7 BURN-IN TESTS

4.7.1 Parameter Drift Values

The parameter drift values applicable to burn-in are specified in Table 4 of this specification. Unless otherwise stated, the measurements shall be performed at $T_{amb} = +22 \pm 3$ °C. The parameter drift values (Δ) applicable to the parameters scheduled, shall not be exceeded. In addition to these drift value requirements, the appropriate limit value specified for a given parameter in Table 2 shall not be exceeded.

4.7.2 Conditions for High Temperature Reverse Bias Burn-in

The requirements for high temperature reverse bias burn-in are specified in Section 7 of ESA/SCC Generic Specification No. 5000. The conditions for high temperature reverse bias burn-in shall be as specified in Table 5(a) of this specification.

4.7.3 Conditions for Power Burn-in

The requirements for power burn-in are specified in Section 7 of ESA/SCC Generic Specification No. 5000. The conditions for power burn-in shall be as specified in Table 5(b) of this specification.

4.7.4 Electrical Circuits for High Temperature Reverse Bias Burn-in

Circuits for use in performing the high temperature reverse bias burn-in are shown in Figure 5(a) of this specification.

4.7.5 Electrical Circuits for Power Burn-in

Circuits for use in performing the power burn-in tests are shown in Figure 5(b) of this specification.

**TABLE 2 - ELECTRICAL MEASUREMENTS AT ROOM TEMPERATURE - d.c. PARAMETERS**

No.	CHARACTERISTICS	SYMBOL	MIL-STD-750 TEST METHOD	TEST CONDITIONS	LIMITS		UNIT
					MIN.	MAX.	
1	Collector-Emitter Breakdown Voltage	$V_{(BR)CEO}$	3011	$I_C = -10\text{mA}$ $I_B = 0\text{mA}$ Note 1	-60	-	V
2	Collector-Base Breakdown Voltage	$V_{(BR)CBO}$	3001	$I_C = -10\mu\text{A}$ $I_E = 0\text{mA}$	-60	-	V
3	Emitter-Base Breakdown Voltage	$V_{(BR)EBO}$	3026	$I_E = -10\mu\text{A}$ $I_C = 0\text{mA}$	-5.0	-	V
4	Collector-Emitter Cut-off Current	I_{CEX}	3041	$V_{CE} = -30\text{V}$ $V_{BE} = 0.5\text{V}$	-	-50	nA
5	Collector-Base Cut-off Current	I_{CBO}	3036	$V_{CB} = -50\text{V}$ $I_E = 0\text{mA}$	-	-10	nA
6	D.C. Forward Current Transfer Ratio 1	h_{FE1}	3076	$I_C = -0.1\text{mA}$ $V_{CE} = -10\text{V}$	75	-	-
7	D.C. Forward Current Transfer Ratio 2	h_{FE2}	3076	$I_C = -10\text{mA}$ $V_{CE} = -10\text{V}$	100	-	-
8	D.C. Forward Current Transfer Ratio 3	h_{FE3}	3076	$I_C = -150\text{mA}$ $V_{CE} = -10$ Note 1	100	300	-
9	D.C. Forward Current Transfer Ratio 4	h_{FE4}	3076	$I_C = -500\text{mA}$ $V_{CE} = -10\text{V}$ Note 1	50	-	-
10	Collector-Emitter Saturation Voltage	$V_{CE(SAT)}$	3071	$I_C = -150\text{mA}$ $I_B = -15\text{mA}$ Note 1	-	-0.4	V
11	Base-Emitter Saturation Voltage	$V_{BE(SAT)}$	3066	$I_C = -150\text{mA}$ $I_B = -15\text{mA}$ Note 1	-	-1.3	V

NOTES1. Pulsed measurement: Pulse Width $\leq 300\mu\text{s}$, Duty Cycle $\leq 2.0\%$.

**TABLE 2 - ELECTRICAL MEASUREMENTS AT ROOM TEMPERATURE - a.c. PARAMETERS**

No.	CHARACTERISTICS	SYMBOL	MIL-STD-750 TEST METHOD	TEST CONDITIONS (NOTE 1)	LIMITS		UNIT
					MIN.	MAX.	
12	A.C. Forward Current Transfer Ratio	h_{fe}	3206	$I_C = -50\text{mA}$ $V_{CE} = -20\text{V}$ $f = 100\text{MHz}$	2.0	-	-
13	Output Capacitance	C_{obo}	3236	$V_{CB} = -10\text{V}$ $I_E = 0\text{mA}$ $100\text{kHz} \leq f \leq 1.0\text{MHz}$	-	8.0	pF
14	Switching Times	t_{on}	Figure 4	$V_{CC} = -30\text{V}$ $I_C = -150\text{mA}$ $I_{B1} = -15\text{mA}$	-	45	ns
15		t_{off}		$V_{CC} = -30\text{V}$ $I_C = -150\text{mA}$ $I_{B1} = I_{B2} = -15\text{mA}$	-	300	

NOTES

1. Performed on a sample basis, LTPD = 7, or less.

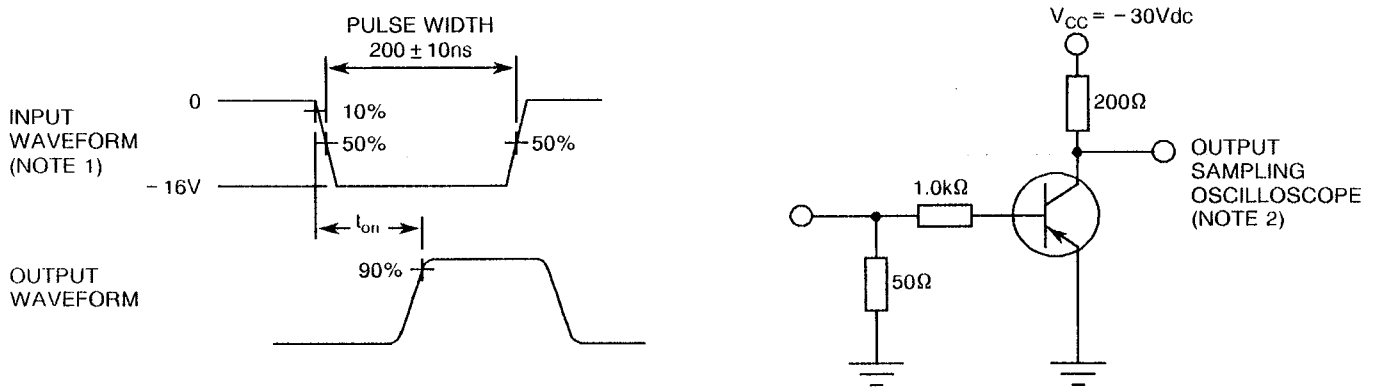
TABLE 3 - ELECTRICAL MEASUREMENTS AT HIGH AND LOW TEMPERATURES

No.	CHARACTERISTICS	SYMBOL	MIL-STD-750 TEST METHOD	TEST CONDITIONS	LIMITS		UNIT
					MIN.	MAX.	
5	Collector-Base Cut-off Current	I_{CBO}	3036	$T_{amb} = +150^\circ\text{C}$ $V_{CB} = -50\text{V}$ $I_E = 0\text{mA}$	-	10	μA

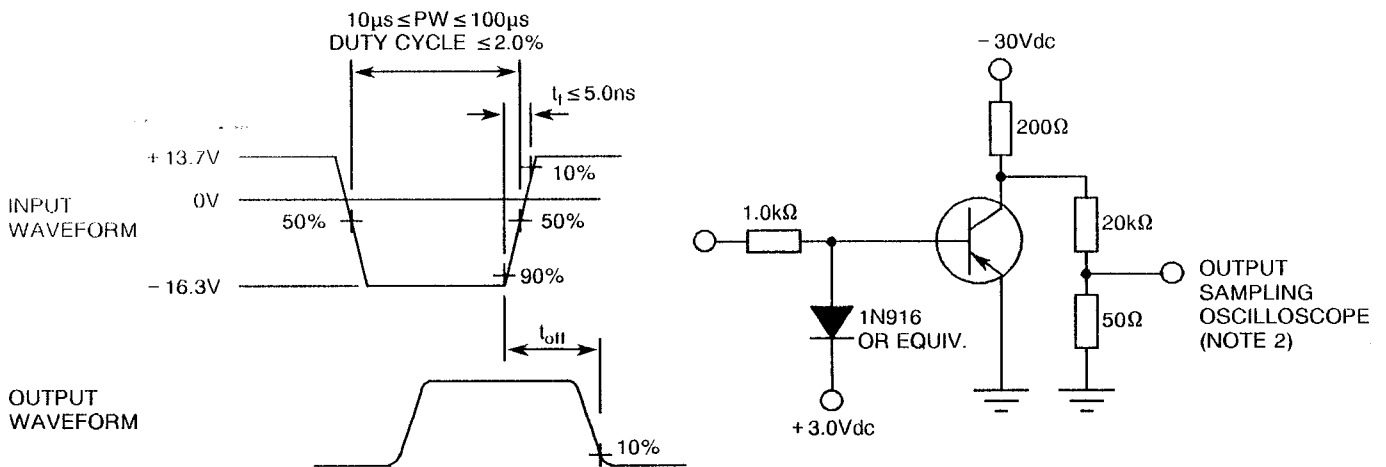


FIGURE 4 - CIRCUITS FOR ELECTRICAL MEASUREMENTS

SATURATED TURN-ON SWITCHING TIME TEST CIRCUIT



SATURATED TURN-OFF SWITCHING TIME TEST CIRCUIT



NOTES

1. The rise time (t_r) of the applied pulse shall be $\leq 2.0\text{ns}$, duty cycle $\leq 2.0\%$ and the generator source impedance shall be 50Ω .
2. Sampling Oscilloscope: $Z_{in} \geq 100\text{k}\Omega$, $C_{in} \leq 12\text{pF}$, rise time $\leq 5.0\text{ns}$.

**TABLE 4 - PARAMETER DRIFT VALUES**

No.	CHARACTERISTICS	SYMBOL	SPEC. AND/OR TEST METHOD	TEST CONDITIONS	CHANGE LIMIT (Δ)	UNIT
5	Collector-Base Cut-off Current	I_{CBO}	As per Table 2	As per Table 2	± 2.0 or (1) ± 100	nA %
8	D.C. Forward Current Transfer Ratio	h_{FE3}	As per Table 2	As per Table 2	± 15	%
10	Collector-Emitter Saturation Voltage	$V_{CE(SAT)}$	As per Table 2	As per Table 2	± 50 or (1) ± 15	mV %

NOTES

1. Whichever is the greater, referred to the initial value.

**TABLE 5(a) - CONDITIONS FOR HIGH TEMPERATURE REVERSE BIAS BURN-IN**

No.	CHARACTERISTICS	SYMBOL	CONDITION	UNIT
1	Ambient Temperature	T_{amb}	+ 150	°C
2	Collector-Base Voltage	V_{CB}	- 50	V
3	Duration	-	48 (+ 4 - 0)	hrs

TABLE 5(b) - CONDITIONS FOR POWER BURN-IN AND OPERATING LIFE TESTS

No.	CHARACTERISTICS	SYMBOL	CONDITION	UNIT
1	Ambient Temperature	T_{amb}	+ 20 to + 50	°C
2	Power Dissipation 1	P_{tot1}	Max. rating at T_{amb} according to derating curve (Note 1)	W
3	Collector-Base Voltage	V_{CB}	40	V

NOTES

1. See Item 5 of Table 1(b) and Figure 1.

FIGURE 5(a) - ELECTRICAL CIRCUIT FOR HIGH TEMPERATURE REVERSE BIAS BURN-IN

Not applicable.

FIGURE 5(b) - ELECTRICAL CIRCUIT FOR POWER BURN-IN AND OPERATING LIFE TESTS

Not applicable.



- 4.8 ENVIRONMENTAL AND ENDURANCE TESTS (CHARTS IV AND V OF ESA/SCC GENERIC SPECIFICATION No. 5000)
- 4.8.1 Electrical Measurements on Completion of Environmental Tests
The parameters to be measured on completion of environmental tests are scheduled in Table 2. Unless otherwise stated, the measurements shall be performed at $T_{amb} = +22 \pm 3$ °C.
- 4.8.2 Electrical Measurements at Intermediate Points and on Completion of Endurance Tests
The parameters to be measured at intermediate points and on completion of endurance testing are scheduled in Table 6 of this specification. Unless otherwise stated, the measurements shall be performed at $T_{amb} = +22 \pm 3$ °C.
- 4.8.3 Conditions for Operating Life Tests (Part of Endurance Testing)
The requirements for operating life testing are specified in Section 9 of ESA/SCC Generic Specification No. 5000. The conditions for operating life testing shall be the same as specified in Table 5(b) for the power burn-in test.
- 4.8.4 Electrical Circuits for Operating Life Tests
The circuit to be used for performance of the operating life test shall be the same as shown in Figure 5(b) for power burn-in.
- 4.8.5 Conditions for High Temperature Storage Test (Part of Endurance Testing)
The requirements for the high temperature storage test are specified in ESA/SCC Generic Specification No. 5000. The temperature to be applied shall be the maximum storage temperature specified in Table 1(b) of this specification.

**SEA**ESA/SCC Detail Specification
No. 5202/001

PAGE 19

ISSUE 6

TABLE 6 - ELECTRICAL MEASUREMENTS AT INTERMEDIATE POINTS AND ON COMPLETION OF ENDURANCE TESTING

No.	CHARACTERISTICS	SYMBOL	SPEC. AND/OR TEST METHOD	TEST CONDITIONS	LIMITS		UNIT
					MIN.	MAX.	
5	Collector-Base Cut-off Current	I_{CBO}	As per Table 2	As per Table 2	-	10	nA
8	D.C. Forward Current Transfer Ratio 3	h_{FE3}	As per Table 2	As per Table 2	100	300	-
10	Collector-Emitter Saturation Voltage	$V_{CE(SAT)}$	As per Table 2	As per Table 2	-	-0.4	V

APPENDIX 'A'

AGREED DEVIATIONS FOR SGS-THOMSON (F)

ITEMS AFFECTED	DESCRIPTION OF DEVIATIONS
<p>Para. 4.2.2</p>	<p>For Chip Carrier Variants, the visual criteria called up by Para. 9.1, as specified in Paras. 3.2.5(i) and (j) of ESA/SCC Basic Specification No. 2045000, may be omitted provided that a Radiographic Inspection to verify the die-attach process is performed in accordance with Para. 9.12.</p> <p>The Radiographic Inspection shall be performed on a sample basis in accordance with STC Procedure 0011828.</p>