



Pages 1 to 19

**CONNECTOR SAVERS, ELECTRICAL,
RECTANGULAR, MINIATURE,
REMOVEABLE CONTACTS,
BASED ON TYPE D*BMA
ESCC Detail Specification No. 3401/020**

**ISSUE 4
December 2006**



Document Custodian: European Space Agency - see <https://escies.org>

	ESCC Detail Specification No. 3401/020		PAGE i ISSUE 4
---	---	--	-------------------

LEGAL DISCLAIMER AND COPYRIGHT

European Space Agency, Copyright © 2006. All rights reserved.

The European Space Agency disclaims any liability or responsibility, to any person or entity, with respect to any loss or damage caused, or alleged to be caused, directly or indirectly by the use and application of this ESCC publication.

This publication, without the prior permission of the European Space Agency and provided that it is not used for a commercial purpose, may be:

- copied in whole in any medium without alteration or modification.
- copied in part, in any medium, provided that the ESCC document identification, comprising the ESCC symbol, document number and document issue, is removed.

DOCUMENTATION CHANGE NOTICE

(Refer to <https://escies.org> for ESCC DCR content)

DCR No.	CHANGE DESCRIPTION
250	Specification upissued to incorporate editorial and technical changes per DCR.

TABLE OF CONTENTS

		<u>Page</u>
1.	<u>GENERAL</u>	5
1.1	Scope	5
1.2	Range of Components and Component Type Variants	5
1.3	Maximum Ratings	5
1.4	Parameter Derating Information	5
1.5	Physical Dimensions	5
2.	<u>APPLICABLE DOCUMENTS</u>	5
3.	<u>TERMS, DEFINITIONS, ABBREVIATIONS, SYMBOLS AND UNITS</u>	5
4.	<u>REQUIREMENTS</u>	10
4.1	General	10
4.2	Deviations from Generic Specification	10
4.2.1	Deviations from Special In-process Controls	10
4.2.2	Deviations from Final Production Tests	10
4.2.3	Deviations from Burn-in and Electrical Measurements	10
4.2.4	Deviations from Qualification Tests	10
4.2.5	Deviations from Lot Acceptance Tests	10
4.3	Mechanical Requirements	10
4.3.1	Dimension Check	10
4.3.2	Weight	10
4.3.3	Contact Capability	10
4.3.4	Contact Retention (in Insert)	11
4.3.5	Mating and Unmating Forces	11
4.3.6	Insert Retention (in Shell)	11
4.3.7	Jackscrew Retention	11
4.3.8	Contact Insertion and Withdrawal Forces	11
4.3.9	Engagement and Separation Forces	11
4.3.10	Oversize Pin Exclusion	11
4.3.11	Probe Damage	11
4.3.12	Solderability	11
4.4	Materials and Finishes	11
4.4.1	Shells	11
4.4.2	Inserts	11
4.4.3	Spacers	12
4.4.4	Contacts	12
4.4.5	Contact Retaining Clip	12
4.4.6	Guiding and Locking Devices	12
4.4.7	Magnetism Level	12
4.5	Marking	12
4.5.1	General	12
4.5.2	Contact Identification	12
4.5.3	The ESCC Component Number	12
4.5.4	Characteristics	13
4.5.5	Traceability Information	14
4.6	Electrical Measurements	14
4.6.1	Electrical Measurements at Room Temperature	14
4.6.2	Electrical Measurements at High and Low Temperatures	14
4.6.3	Circuit for Electrical Measurements	16
4.7	Burn-in and Electrical Measurements	16

	<p style="text-align: center;">ESCC Detail Specification No. 3401/020</p>		<p>PAGE 4 ISSUE 4</p>
---	---	--	---------------------------

	<u>Page</u>
4.8 Environmental and Endurance Tests	16
4.8.1 Measurements and Inspections on Completion of Environmental Tests	16
4.8.2 Measurements and Inspections at Intermediate Points during Endurance Tests	16
4.8.3 Measurements and Inspections on Completion of Endurance Tests	16
4.8.4 Conditions for Operating Life Test	16
4.8.5 Electrical Circuits for Operating Life Tests	16
4.8.6 Conditions for High Temperature Storage Test	16

TABLES

1(a) Range of Components and Type Variants	6
1(b) Maximum Ratings	6
2 Electrical Measurements at Room Temperature	15
3 Not applicable	N/A
4 Not applicable	N/A
5 Not applicable	N/A
6 Measurements and Inspections on Completion of Environmental and Endurance Tests	17

FIGURES

1 Parameter Derating Information	7
2 Physical Dimensions	8

APPENDICES (Applicable to specific Manufacturers only)

'A' ITT CANNON (F)	19
--------------------	----

	<p style="text-align: center;">ESCC Detail Specification No. 3401/020</p>		<p>PAGE 5 ISSUE 4</p>
---	---	--	---------------------------

1. GENERAL

1.1 SCOPE

This specification details the ratings, physical and electrical characteristics, test and inspection data for Connector Savers, Electrical, Rectangular with Removable Contacts, Standard (Gauge 20) and High Density (Gauge 22) Contact Arrangements, based on Type D*BMA.
It shall be read in conjunction with:-

ESCC Generic Specification No. 3401, Connectors, Electrical, Non-Filtered, Circular and Rectangular.

ESCC Detail Specification No. 3401/021, Contacts, Electrical, Male/Female Type, for 3401/020 Connector Savers.

ESCC Detail Specification No. 3401/022, Accessories for Rectangular Connectors 3401/001, 3401/002 and Connector Savers 3401/020.

the requirements of which are supplemented herein.

1.2 RANGE OF COMPONENTS AND COMPONENT TYPE VARIANTS

The different sizes of connector savers specified herein, which are also covered by this specification, together with their mechanical characteristics, are given in Table 1(a).

1.3 MAXIMUM RATINGS

The maximum ratings, which shall not be exceeded at any time during use or storage, applicable to the connector savers specified herein, are scheduled in Table 1(b).

1.4 PARAMETER DERATING INFORMATION

The applicable derating information for the connector savers specified herein is shown in Figure 1.

1.5 PHYSICAL DIMENSIONS

The physical dimensions of the connector savers specified herein are shown in Figure 2.

2. APPLICABLE DOCUMENTS

The following documents form part of this specification and shall be read in conjunction with it:-

- (a) ESCC Generic Specification No. 3401 for Connectors, Electrical, Non-Filtered, Circular and Rectangular.
- (b) ESCC Detail Specification No. 3401/021, Contacts, Electrical, Male/Female Type, for 3401/020 Connector Savers.
- (c) ESCC Detail Specification No. 3401/022, Accessories for Rectangular Connectors 3401/001, 3401/002 and Connector Savers 3401/020.
- (d) QQ-B-613, Brass Material.
- (e) MIL-G-45204, Gold Plating, Electro-deposited.
- (f) MIL-C-14550, Copper Plating, Electro-deposited.
- (g) MIL-P-19833, Glass, Fibre-filled Diallyl Phthalate Resin.
- (h) MIL-C-24308, Rack and Panel Connectors, Miniature.
- (i) MIL-M-14, Moulding Plastics and Moulded Plastic Parts, Thermosetting.

3. TERMS, DEFINITIONS, ABBREVIATIONS, SYMBOLS AND UNITS

For the purpose of this specification, the terms, definitions, abbreviations, symbols and units specified in ESCC Basic Specification No. 21300 shall apply.

TABLE 1(a) - RANGE OF COMPONENTS AND TYPE VARIANTS

SHELL SIZE (1)	MAX. WEIGHT (g) (2)		MATING FORCE (N. max)		UNMATING FORCE			
					N. min		N. max	
	Var. 01 (3)	Var. 02 (4)	Var. 01 (3)	Var. 02 (4)	Var. 01 (3)	Var. 02 (4)	Var. 01 (3)	Var. 02 (4)
E	9.9	9.5	30	46	3.5	3.4	20	28
A	13.7	13.2	50	77	4.5	4.5	34	46
B	18.4	17.8	83	127	8.0	7.9	55	77
C	23.9	23.2	123	177	11.0	11.3	83	109
D	26.8	26.1	166	222	14.5	14.7	120	136
F	-	32.0	-	295	-	20.3	-	177

NOTES

1. See Figure 2(a).
2. Without contacts. See ESCC Detail Specification No. 3401/021 for contact weights.
3. Standard contact arrangements.
4. High density contact arrangements.

TABLE 1(b) - MAXIMUM RATINGS

No.	CHARACTERISTICS	SYMBOL	MAXIMUM RATING	UNIT	REMARKS
1	Working Voltage (Sea Level) - Variant 01 - Variant 02	U_R	300 250	Vrms Vrms	
2	Operating Temperature Range	T_{op}	- 55 to +125	°C	T_{amb}
3	Storage Temperature Range	T_{stg}	- 65 to +125	°C	

FIGURE 1 - PARAMETER DERATING INFORMATION

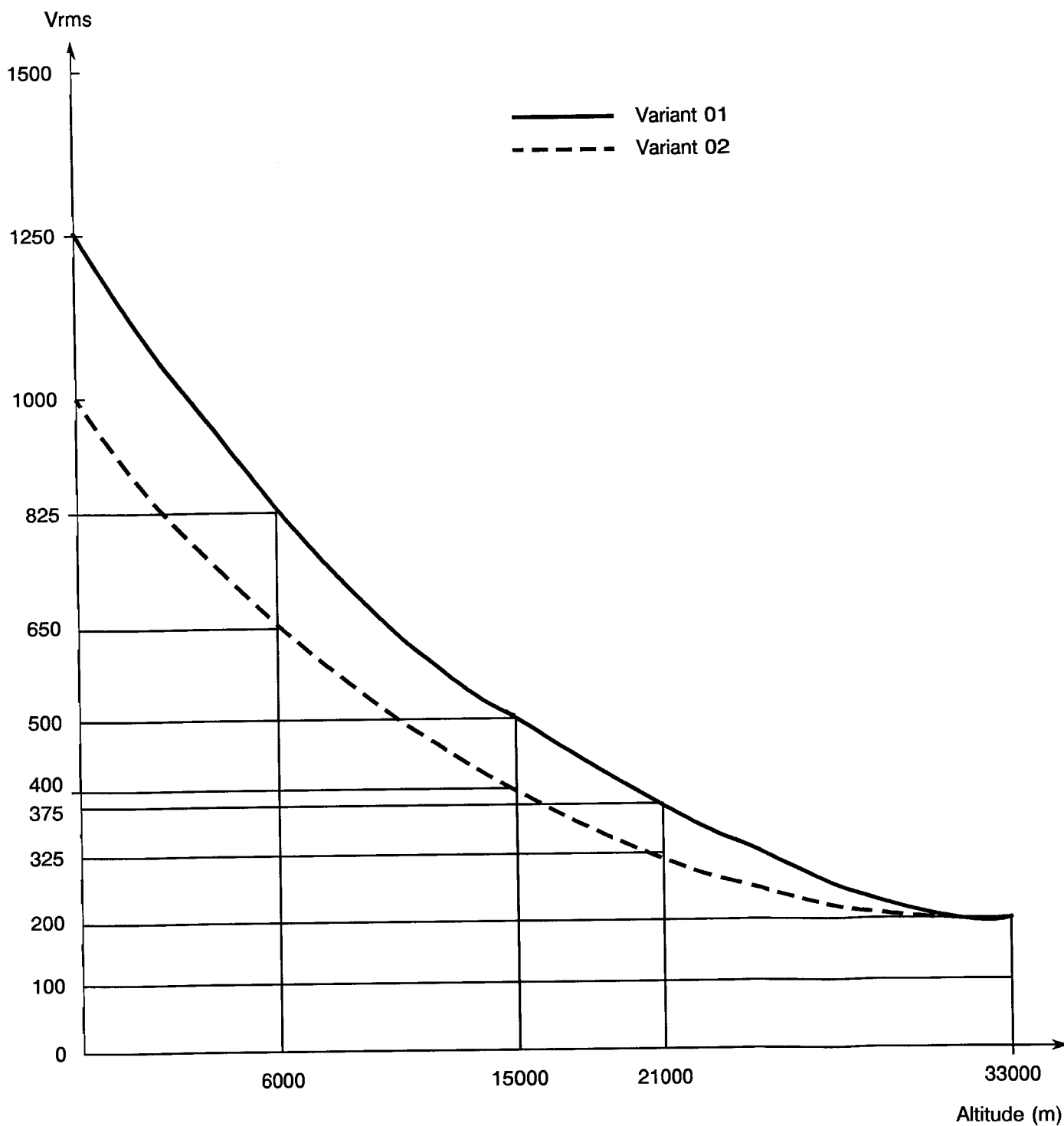

Voltage Proof versus Altitude

FIGURE 2 - PHYSICAL DIMENSIONS

FIGURE 2(a) - CONNECTOR SAVERS

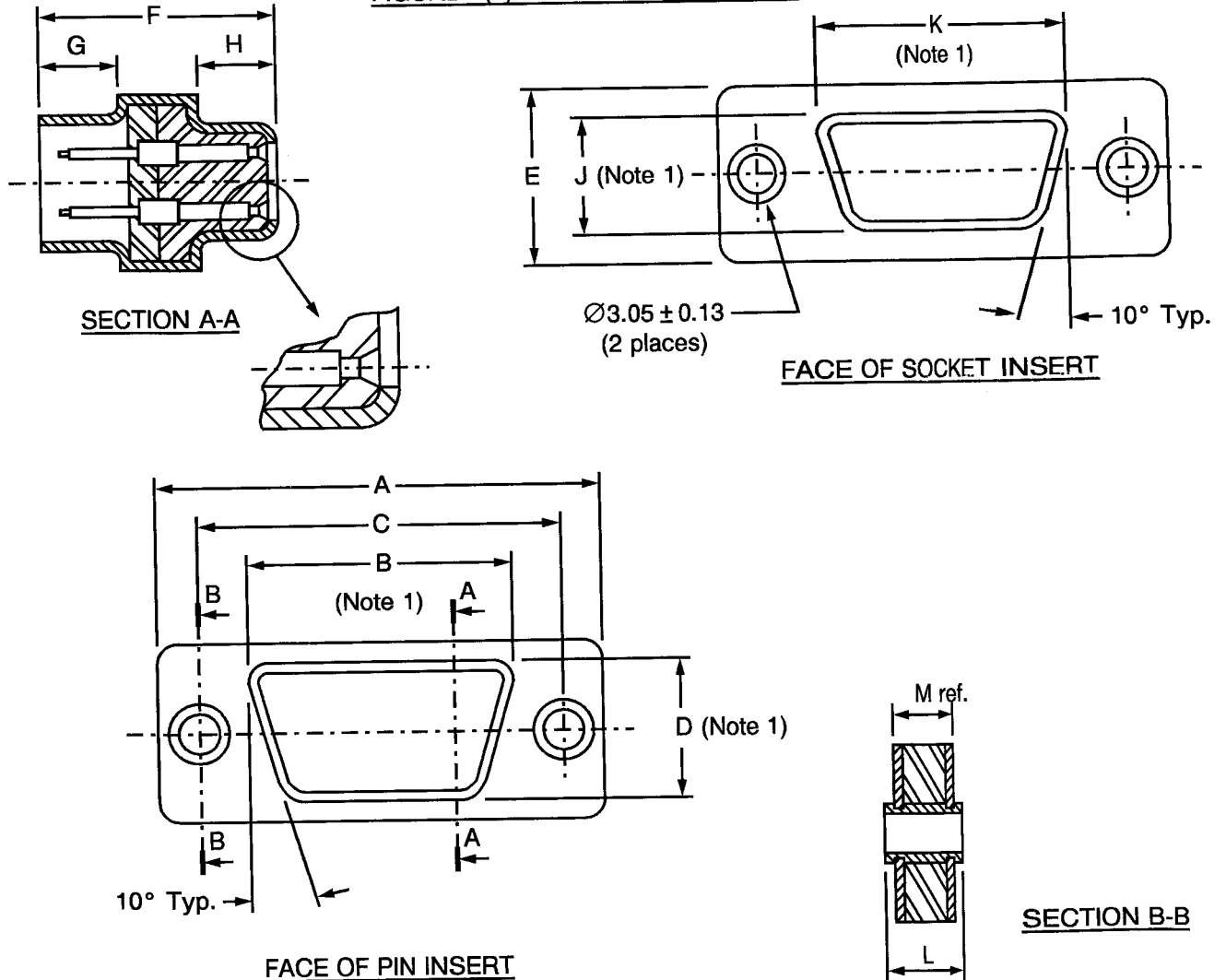

NOTES

1. Dimensions B, D, J and K pertain to front and rear shell keystone and are taken at bottom of draw.
2. All dimensions are in millimetres (angles in degrees).
3. Underlined dimensions, in Table, are critical to ensure mateability.

Shell Size	Dimensions	A	B	<u>C</u>	D	E	F	<u>G</u>	<u>H</u>	<u>J</u>	<u>K</u>	L	M
E	Min.	30.43	17.45	24.87	8.89	12.17	21.62	5.74	5.92	7.57	16.01	10.21	9.61
	Max.	31.19	17.95	25.12	9.39	12.93	22.12	6.24	6.42	8.07	16.51	10.97	10.11
A	Min.	38.76	25.79	33.20	8.89	12.17	21.62	5.74	5.92	7.57	24.34	10.21	9.61
	Max.	39.52	26.29	33.45	9.39	12.93	22.12	6.24	6.42	8.07	24.84	10.97	10.11
B	Min.	52.65	39.96	46.91	9.35	12.17	21.72	5.62	5.92	7.57	38.05	10.21	9.61
	Max.	53.42	40.46	47.17	9.85	12.93	22.22	6.12	6.42	8.07	38.55	10.97	10.11
C	Min.	68.94	56.42	63.37	9.35	12.17	21.72	5.62	5.92	7.57	54.51	10.21	9.61
	Max.	69.70	56.92	63.63	9.85	12.93	22.22	6.12	6.42	8.07	55.01	10.97	10.11
D	Min.	66.55	53.78	60.99	12.04	14.99	21.72	5.62	5.92	10.42	52.12	10.21	9.61
	Max.	67.31	54.28	61.24	12.54	15.75	22.22	6.12	6.42	10.92	52.62	10.97	10.11
F	Min.	68.94	56.06	63.37	12.65	16.92	21.72	5.69	6.05	12.19	55.47	10.21	9.61
	Max.	69.70	56.31	63.63	12.90	17.68	22.22	5.99	6.30	12.45	55.73	10.97	10.11

FIGURE 2 - PHYSICAL DIMENSIONS (CONTINUED)

FIGURE 2(b) - CONTACT ARRANGEMENTS

**VARIANT 01 - STANDARD CONTACT ARRANGEMENTS
(FRONT VIEW MALE INSERT)**

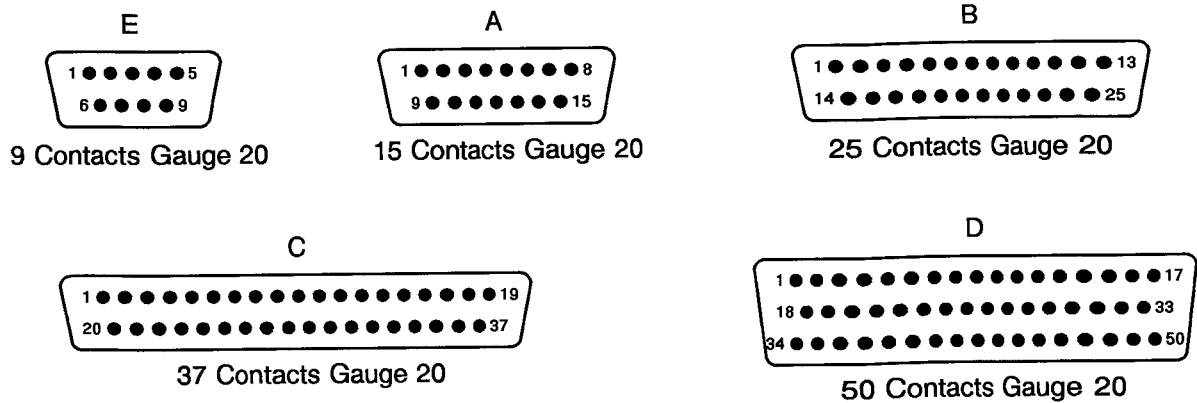

**VARIANT 02 - HIGH DENSITY CONTACT ARRANGEMENTS
(FRONT VIEW MALE INSERT)**

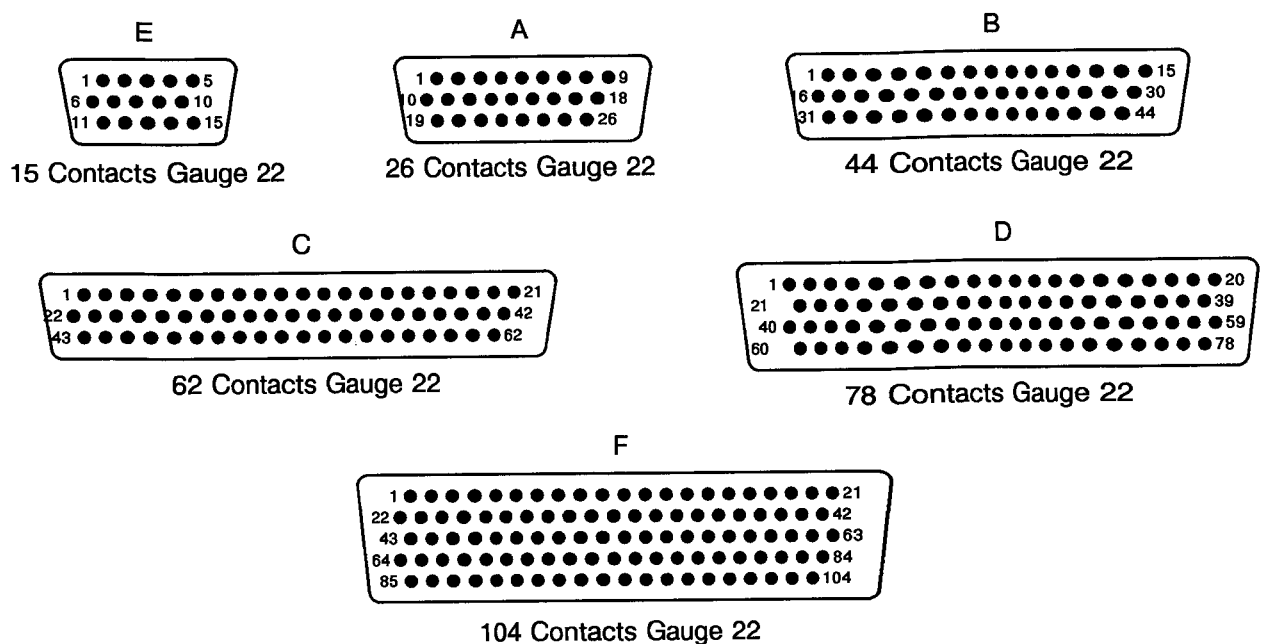

NOTES

1. Contact locations are in conformity with MIL-C-24308 specification sheets and shall not be checked during procurement.
2. Both sides of the insert shall be marked with the minimum marking shown.

	<p style="text-align: center;">ESCC Detail Specification No. 3401/020</p>	<p style="text-align: right;">PAGE 10 ISSUE 4</p>
---	---	---

4. REQUIREMENTS

4.1 GENERAL

The complete requirements for procurement of the connectors specified herein are stated in this specification and ESCC Generic Specification No. 3401. Deviations from the Generic Specification, applicable to this specification only, are listed in Para. 4.2.

Deviations from the applicable Generic Specification and this Detail Specification, formally agreed with specific Manufacturers on the basis that the alternative requirements are equivalent to the ESCC requirements and do not affect the components' reliability, are listed in the appendices attached to this specification.

4.2 DEVIATIONS FROM GENERIC SPECIFICATION

4.2.1 Deviations from Special In-process Controls

None.

4.2.2 Deviations from Final Production Tests (Chart II)

(a) Para. 9.1.1.4, Mated Shell Conductivity: Not applicable.

4.2.3 Deviations from Burn-in and Electrical Measurements (Chart III)

Not applicable.

4.2.4 Deviations from Qualification Tests (Chart IV)

- (a) Para. 9.1.1.4, Mated Shell Conductivity: Not applicable.
- (b) Para. 9.9, Seal Test: Not applicable.
- (c) Para. 9.10, Wiring: Not applicable.
- (d) Para. 9.24, Jackscrew Retention: Not applicable.

4.2.5 Deviations from Lot Acceptance Tests (Chart V)

- (a) Para. 9.1.1.4, Mated Shell Conductivity: Not applicable.
- (b) Para. 9.9, Seal Test: Not applicable.
- (c) Para. 9.10, Wiring: Not applicable.

4.3 MECHANICAL REQUIREMENTS

4.3.1 Dimension Check

The dimensions of the connector savers specified herein shall be verified in accordance with the requirements set out in Para. 9.6 of ESCC Generic Specification 3401 and shall conform to those shown in Figure 2 of this specification.

4.3.2 Weight

The maximum weight of the connector savers specified herein, without contacts, shall be as specified in Table 1(a).

4.3.3 Contact Capability

As specified in ESCC Detail Specification No. 3401/021.

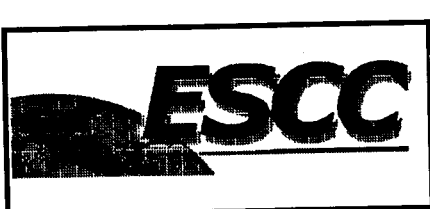
	<p style="text-align: center;">ESCC Detail Specification No. 3401/020</p>	<p style="text-align: right;">PAGE 11 ISSUE 4</p>
--	---	---

4.3.4 Contact Retention (in Insert)

As specified in ESCC Detail Specification No. 3401/021.

4.3.5 Mating and Unmating Forces

The forces applied for mating and unmating of the connector savers shall conform to the values specified in Table 1(a).

4.3.6 Insert Retention (In Shell)

Connector saver inserts shall withstand a pressure of 42.8N/cm² without being dislodged from the shell.

4.3.7 Jackscrew Retention

Not applicable.

4.3.8 Contact Insertion and Withdrawal Forces

As specified in ESCC Detail Specification No. 3401/021.

4.3.9 Engagement and Separation Forces

As specified in ESCC Detail Specification No. 3401/021.

4.3.10 Oversize Pin Exclusion

As specified in ESCC Detail Specification No. 3401/021.

4.3.11 Probe Damage

As specified in ESCC Detail Specification No. 3401/021.

4.3.12 Solderability

Not applicable.

4.4 MATERIALS AND FINISHES

The materials and finishes shall be as specified herein. Where a definite material is not specified, a material which will enable the connectors specified herein to meet the performance requirements of this specification shall be used. Acceptance or approval of any constituent material does not guarantee acceptance of the finished product.

4.4.1 Shells

Shells of shell sizes E, A, B, C and D shall be made of brass. The plating shall be 0.7µm minimum of gold over 1.0µm of copper.

Shells of shell size F shall be made of aluminium alloy. The plating shall be either 25.4µm of electroless nickel (Modification Code A174), or 0.7µm minimum of gold with 25.4µm minimum electroless nickel underplating (Modification Code FR172).

4.4.2 Inserts

Inserts shall be made of glass-fibre filled diallylphthalate resin or a suitable thermoplastic material.

4.4.3 Spacers

Spacers shall be made of polyimide material.

4.4.4 Contacts

As specified in ESCC Detail Specification No. 3401/021.

4.4.5 Contact Retaining Clip

The retaining clip shall be made of beryllium copper.

4.4.6 Guiding and Locking Devices

As specified in ESCC Detail Specification No. 3401/022.

4.4.7 Magnetism Level

The allowable value of magnetism shall not exceed that specified for the relevant level (see Para. 4.5.4.6).

4.5 MARKING

4.5.1 General

The marking of all components delivered to this specification shall be in accordance with the requirements of ESCC Basic Specification No. 21700 and the following paragraphs. When the component is too small to accommodate all of the marking specified, as much as space permits shall be marked and the marking information, in full, shall accompany the component in its primary package.

Each component shall be marked in respect of:-

- (a) Contact Identification.
- (b) The ESCC Component Number.
- (c) Characteristics.
- (d) Traceability Information.

4.5.2 Contact Identification

Contact identification shall be marked in accordance with Figure 2.

4.5.3 The ESCC Component Number

Each component shall bear the ESCC Component Number which shall be constituted and marked as follows:

Detail Specification Number	340102001B
Type Variant (see Table 1(a))	
Testing Level	



4.5.4 Characteristics

The characteristics to be marked in the following order of precedence are:-

- (a) Series.
- (b) Shell size.
- (c) Insert type.
- (d) Contact arrangement.
- (e) Type of contact.
- (f) Magnetism Level.
- (g) Modification Code.

The information shall be constituted and marked as follows:-

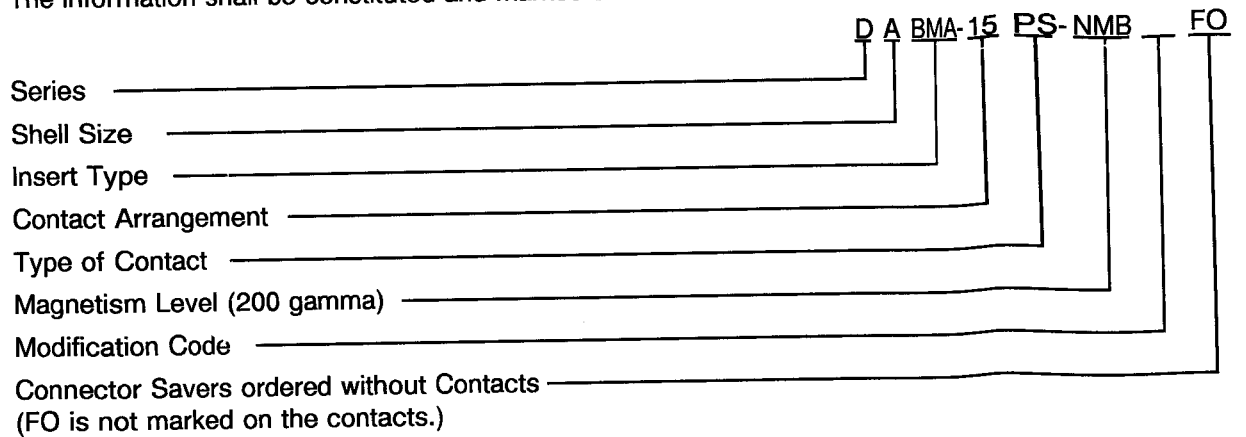

4.5.4.1 Series

This connector saver series shall be designated by the letter 'D'.

4.5.4.2 Shell Size

The shell size shall be indicated by the letters specified hereafter:-

Code	E	A	B	C	D	F ₍₁₎
------	---	---	---	---	---	------------------

N.B.

- 1. Variant 02 Only.

4.5.4.3 Insert Type

The insert type with contacts is defined by the letters "BMA".

4.5.4.4 Contact Arrangements

The number of contacts shall be as shown in Figure 2(b) and contact arrangements shall be indicated by the codes specified hereafter:-

SHELL SIZE	CODE	
	Variant 01	Variant 02
E	9	15
A	15	26
B	25	44
C	37	62
D	50	78
F	-	104

4.5.4.5 Type of Contact

The contact types shall be indicated by the following code letters:-

CODE LETTER	CONTACT TYPE
PS	Male/Female

4.5.4.6 Magnetism Level

The following codes shall be used for magnetism level:-

CODE	DEFINITION
NMA	Magnetism Level: \leq 2000 gamma
NMB	Magnetism Level: \leq 200 gamma
NMC	Magnetism Level: \leq 20 gamma
NMD	Magnetism Level: \leq 2 gamma

4.5.4.7 Modification Code

The modification code for the finish of shell size F (aluminium alloy) shall be:

- A174 for the electroless nickel finish
- FR172 for the gold over electroless nickel finish.

The modification code shall be omitted for shell sizes E, A, B, C and D.

4.5.5 Traceability Information

Traceability information shall be marked in accordance with the requirements of ESCC Basic Specification No. 21700.

4.6 ELECTRICAL MEASUREMENTS

4.6.1 Electrical Measurements at Room Temperature

The parameters to be measured in respect of electrical characteristics are scheduled in Table 2. Unless otherwise specified, these measurements shall be performed at $T_{amb} = +22 \pm 3$ °C.

4.6.2 Electrical Measurements at High and Low Temperatures (Table 3)

Not applicable.

TABLE 2 - ELECTRICAL MEASUREMENTS AT ROOM TEMPERATURE

No.	CHARACTERISTIC	SYMBOL	ESCC 3401 TEST METHOD	TEST CONDITION	LIMITS		UNIT
					MIN.	MAX.	
1	Insulation Resistance	R _i	Para. 9.1.1.1	Para. 9.1.1.1	5000	-	MΩ
2	Voltage Proof Leakage Current Variant 01 Variant 02	I _L	Para. 9.1.1.2	1250Vrms 1000Vrms	- -	2.0 2.0	mA mA
3	Mated Shell Conductivity (Voltage Drop) (1)	V _d	Para. 9.1.1.4	Para. 9.1.1.4	Not applicable		mV

NOTES

1. Applicable to mated connectors with grounding option.

TABLES 3, 4 AND 5

Not applicable.

	<p style="text-align: center;">ESCC Detail Specification No. 3401/020</p>	<p style="text-align: right;">PAGE 16 ISSUE 4</p>
---	---	---

4.6.3 Circuit for Electrical Measurements (Figure 4)

Not applicable.

4.7 BURN-IN AND ELECTRICAL MEASUREMENTS (TABLES 4 AND 5)

Not applicable.

4.8 ENVIRONMENTAL AND ENDURANCE TESTS (CHARTS IV AND V OF ESCC GENERIC SPECIFICATION NO. 3401)

4.8.1 Measurements and Inspections on Completion of Environmental Tests

The parameters to be measured and inspections to be performed on completion of environmental tests are scheduled in Table 6. Unless otherwise stated, the measurements shall be performed at $T_{amb} = +22 \pm 3 \text{ }^{\circ}\text{C}$.

4.8.2 Measurements and Inspections at Intermediate Points during Endurance Tests

Not applicable.

4.8.3 Measurements and Inspections on Completion of Endurance Tests

The parameters to be measured and inspections to be performed on completion of endurance tests are scheduled in Table 6. Unless otherwise stated, the measurements shall be performed at $T_{amb} = +22 \pm 3 \text{ }^{\circ}\text{C}$.

4.8.4 Conditions for Operating Life Tests (Part of Endurance Testing)

Not applicable.

4.8.5 Electrical Circuits for Operating Life Tests (Figure 5)

Not applicable.

4.8.6 Conditions for High Temperature Storage Test (Part of Endurance Testing)

The requirements for the high temperature storage test are specified in Section 9 of ESCC Generic Specification No. 3401. The conditions for high temperature storage testing shall be the maximum storage temperature specified in Table 1(b) of this specification.



TABLE 6 - MEASUREMENTS AND INSPECTIONS ON COMPLETION OF ENVIRONMENTAL AND ENDURANCE TESTS

NO.	ESCC GENERIC SPEC. NO. 3401		MEASUREMENTS AND INSPECTIONS		SYMBOL	LIMITS		UNIT
	ENVIRONMENTAL AND ENDURANCE TESTS (1)	TEST METHOD AND CONDITIONS	IDENTIFICATION	CONDITIONS		MIN.	MAX.	
01	Seal Test	Para. 9.9	ESCC 3401 Para. 9.9			Not applicable		
02	Wiring	Para. 9.10	Not applicable					
03	Vibration	Para. 9.11	Initial Measurements Coupling Screw(s) Unlocking Torque Final Measurements Full Engagement Coupling Screw(s) Unlocking Torque Drift Visual Examination	- - - -	- Δ -	Not applicable Not applicable -		
04	Shock or Bump	Para. 9.12	Full Engagement Visual Examination	- -	- -	- -	- -	- -
05	Climatic Sequence	Para. 9.13	Dry Heat Insulation Resistance Low Air Pressure Voltage Proof Leakage Current Damp Heat Insulation Resistance External Visual Inspection Insulation Resistance Voltage Proof Leakage Current	Table 2 Item 1 Figure 1 Immediately after test Table 2 Item 1 After 1-24 hrs Recovery ESCC 3401 Para. 9.7 Table 2 Item 1 Table 2 Item 2	Ri I _L Ri - Ri I _L	1000 Table 2 Item 2 100 ESCC 3401 Para. 9.7 Table 2 Item 1 Table 2 Item 2	- - - -	MΩ MΩ -
06	Plating Thickness	Para. 9.14	Thickness	-	-	ESCC 3401/021		
07	Joint Strength	Para. 9.15	ESCC 3401 Para. 9.15	-	-	ESCC 3401 Para. 9.15		
08	Rapid Change of Temperature	Para. 9.16	Visual Examination Insulation Resistance Voltage Proof Leakage Current	Table 2 Item 1 Table 2 Item 2	Ri I _L	Table 2 Item 1 Table 2 Item 2		
09	Contact Retention (in Insert)	Para. 9.17 & Para. 4.3.4 of this spec.	Contact Displacement	-	-	ESCC 3401 Para. 9.17		
10	Endurance	Para. 9.18	Initial Measurements Mating/Unmating Forces Low Level Contact Resist Mated Shell Conductivity Final Measurements Visual Examination Mating/Unmating Forces Low Level Contact Resistance Drift Mated Shell Conductivity Insulation Resistance Voltage Proof Leakage Current	- ESCC 3401/021 Table 2 Item 3 - - ESCC 3401/021 Table 2 Item 3 Table 2 Item 1 Table 2 Item 2	F Rcl Vd - F ΔRcl Vd Ri I _L	Para. 4.3.5 of this spec. Record Values Not applicable - - Para. 4.3.5 of this spec. ESCC 3401/021 Not applicable Table 2 Item 1 Table 2 Item 2		

NOTES

1. The tests in this Table refer to either Chart IV or V and shall be used as applicable.



TABLE 6 - MEASUREMENTS AND INSPECTIONS ON COMPLETION OF ENVIRONMENTAL AND ENDURANCE TESTS (CONT'D)

NO.	ESCC GENERIC SPEC. NO. 3401		MEASUREMENTS AND INSPECTIONS		SYMBOL	LIMITS		UNIT
	ENVIRONMENTAL AND ENDURANCE TESTS (1)	TEST METHOD AND CONDITIONS	IDENTIFICATION	CONDITIONS		MIN.	MAX.	
11	Permanence of Marking	Para. 9.19	As applicable	-	-	-	-	-
12	Mating/Unmating Forces	Para. 9.20	Force	-	F	Para. 4.3.5 of this spec.		-
13	High Temperature Storage	Para. 9.21	Initial Measurements Low Level Contact Resistance Mated Shell Conductivity Final Measurements Visual Examination Mating/Unmating Forces Low Level Contact Resistance Drift Rated Current Contact Resistance Mated Shell Conductivity Insulation Resistance Voltage Proof Leakage Current Contact Retention (in Insert)	ESCC 3401/021 Table 2 Item 3 - ESCC 3401/021 ESCC 3401/021 Table 2 Item 3 Table 2 Item 1 Table 2 Item 2 Para. 4.3.4 of this spec.	Rcl Vd - F ΔRcl Rcr Vd Ri I _L -	Record Values Not applicable - Para. 4.3.5 of this spec. ESCC 3401/021 ESCC 3401/021 Not applicable Table 2 Item 1 Table 2 Item 2 ESCC 3401 Para. 9.17	-	
14	Corrosion	Para. 9.22	Visual Examination	-	-	-	-	-
15	Insert Retention (in Shell)	Para. 9.23 & Para. 4.3.6 of this spec.	Visual Examination	-	-	Para. 4.3.6		-
16	Jackscrew Retention	Para. 9.24 & Para. 4.3.7 of this spec.	Visual Examination	-	-	Not applicable		-
17	High Temperature Measurements	Para. 9.25	Insulation Resistance	Table 2 Item 1	Ri	500	-	MΩ
18	Overload Test	Para. 9.26	Internal Temperature Rated Current Contact Resistance Mated Shell Conductivity Insulation Resistance Voltage Proof Leakage Current	ESCC 3401/021 Table 2 Item 3 Table 2 Item 1 Table 2 Item 2	T Hcr Vd Ri I _L	-	+ 100	°C
19	Maintenance Aging	Para. 9.27	Visual Examination Contact Retention Contact Insertion & Withdrawal Forces	Para. 4.3.4 of this spec. Para. 4.3.8 of this spec.	-	-	-	-
20	Engage/Separation Forces	Para. 9.28 & Para. 4.3.9 of this spec.	Force	-	-	Para. 4.3.9		-
21	Oversize Pin Exclusion	Para. 9.29 & Para. 4.3.10 of this spec.	-	-	-	ESCC 3401 Para. 9.29		-
22	Probe Damage	Para. 9.30 & Para. 4.3.11 of this spec.	Contact Separation Force	Para. 4.3.9 of this spec.	-	Para. 4.3.9		-
23	Solderability	Para. 9.31 & Para. 4.3.12 of this spec.	-	-	-	Para. 4.3.12		-

NOTES

1. The tests in this Table refer to either Chart IV or V and shall be used as applicable.

	<p>ESCC Detail Specification No. 3401/020</p>	<p>PAGE 19 ISSUE 4</p>
---	---	----------------------------

APPENDIX 'A'

Page 1 of 1

AGREED DEVIATIONS FOR ITT CANNON (F)

ITEMS AFFECTED	DESCRIPTION OF DEVIATIONS
Para. 4.2.2	Para. 9.3, Contact Retainer Test may be omitted provided that a 100% external visual inspection of the contact retainer clips positioned within the insert is performed in accordance with the ITT CANNON PID requirements.