



**CONNECTORS, ELECTRICAL, CIRCULAR,
TRIPLE-START SELF-LOCKING COUPLING,
SCOOP-PROOF, REMOVABLE CRIMP CONTACTS**

BASED ON MIL-DTL-38999 SERIES III

ESCC Detail Specification No. 3401/056

Issue 9	April 2022
---------	------------



LEGAL DISCLAIMER AND COPYRIGHT

European Space Agency, Copyright © 2022. All rights reserved.

The European Space Agency disclaims any liability or responsibility, to any person or entity, with respect to any loss or damage caused, or alleged to be caused, directly or indirectly by the use and application of this ESCC publication.

This publication, without the prior permission of the European Space Agency and provided that it is not used for a commercial purpose, may be:

- copied in whole, in any medium, without alteration or modification.
- copied in part, in any medium, provided that the ESCC document identification, comprising the ESCC symbol, document number and document issue, is removed.

DOCUMENTATION CHANGE NOTICE

(Refer to <https://escies.org> for ESCC DCR content)

DCR No.	CHANGE DESCRIPTION
1491	Specification updated to incorporate changes per DCR.

TABLE OF CONTENTS

1	GENERAL	6
1.1	SCOPE	6
1.2	RANGE OF COMPONENTS	6
1.3	MAXIMUM RATINGS	6
1.4	PARAMETER DERATING INFORMATION	6
1.5	PHYSICAL DIMENSIONS	6
2	APPLICABLE DOCUMENTS	6
3	TERMS, DEFINITIONS, ABBREVIATIONS, SYMBOLS AND UNITS	17
4	REQUIREMENTS	17
4.1	GENERAL	17
4.2	DEVIATIONS FROM GENERIC SPECIFICATION	17
4.2.1	Deviations from Special In-process Controls	17
4.2.2	Deviations from Final Production Tests (Chart II)	17
4.2.3	Deviations from Burn-in and Electrical Measurements (Chart III)	17
4.2.4	Deviations from Qualification Tests (Chart IV)	17
4.2.5	Deviations from Lot Acceptance Tests (Chart V)	17
4.3	MECHANICAL REQUIREMENTS	18
4.3.1	Dimension Check	18
4.3.2	Weight	18
4.3.3	Contact Capability	18
4.3.4	Contact Retention (In Insert)	18
4.3.5	Mating and Unmating Forces	18
4.3.6	Insert Retention (In Shell)	18
4.3.7	Jackscrew Retention	18
4.3.8	Contact Insertion and Withdrawal Forces	18
4.3.9	Engagement and Separation Forces	18
4.3.10	Oversize Pin Exclusion	18
4.3.11	Probe Damage	18
4.3.12	Solderability	18
4.4	MATERIALS AND FINISHES	19
4.4.1	Shell, Coupling Ring and Nuts	19
4.4.2	Inserts	19
4.4.3	Contacts	19
4.4.4	Contact Retaining Clip	19
4.4.5	Guiding and Locking Devices	19
4.4.6	Magnetism Level	19

4.5	MARKING	19
4.5.1	General	19
4.5.2	Contact Identification	19
4.5.3	The ESCC Component Number	19
4.5.4	Characteristics	20
4.5.5	Traceability Information	22
4.5.6	Marking of Small Components	22
4.6	ELECTRICAL MEASUREMENTS	22
4.6.1	Electrical Measurements at Room Temperature	22
4.6.2	Electrical Measurements at High and Low Temperatures (Table 3)	22
4.6.3	Circuits for Electrical Measurements (Figure 4)	22
4.7	BURN-IN AND ELECTRICAL MEASUREMENTS (TABLES 4 AND 5)	22
4.8	ENVIRONMENTAL AND ENDURANCE TESTS (CHARTS IV AND V OF ESCC GENERIC SPECIFICATION NO. 3401)	23
4.8.1	Measurements and Inspections on Completion of Environmental Tests	23
4.8.2	Measurements and Inspections at Intermediate Points during Endurance Tests	23
4.8.3	Measurements and Inspections on Completion of Endurance Tests	23
4.8.4	Conditions for Operating Life Test (Part of Endurance Testing)	23
4.8.5	Electrical Circuits for Operating Life Test	23
4.8.6	Conditions for High Temperature Storage Test (Part of Endurance Testing)	23

1 GENERAL

1.1 SCOPE

This specification details the ratings, physical and electrical characteristics, test and inspection data for Connectors, Electrical, Circular, Triple-Start Self-Locking Coupling, Scoop-proof, Removable Crimp Contacts, Based on [MIL-DTL-38999](#) Series III. It shall be read in conjunction with:

- ESCC Generic Specification No. [3401](#), Connectors, Electrical, Non-Filtered, Circular and Rectangular.
- ESCC Detail Specification No. [3401/058](#), Contacts, Electrical, Crimp, for [3401/052](#) and [/056](#) Connectors.
- ESCC Detail Specification No. [3401/062](#), Accessories for Circular Connectors [3401/044](#), [3401/052](#) and [3401/056](#).
- ESCC Detail Specification No. [3401/066](#), Contacts, Electrical, Triax, Crimp for [3401/056](#) Connectors.

the requirements of which are supplemented herein.

1.2 RANGE OF COMPONENTS

The different sizes of connectors specified herein, which are also covered by this specification, together with their mechanical characteristics, are given in Table 1(a).

1.3 MAXIMUM RATINGS

The maximum ratings, which shall not be exceeded at any time during use or storage, applicable to the connectors specified herein, are scheduled in Table 1(b).

1.4 PARAMETER DERATING INFORMATION

The applicable derating information for the connectors specified herein is shown in Figure 1.

1.5 PHYSICAL DIMENSIONS

The physical dimensions of the connectors specified herein are shown in Figure 2.

2 APPLICABLE DOCUMENTS

The following documents form part of this specification and shall be read in conjunction with it:

- (a) ESCC Generic Specification No. [3401](#), Connectors, Electrical, Non-Filtered, Circular and Rectangular.
- (b) ESCC Detail Specification No. [3401/058](#), Contacts, Electrical, Crimp, for [3401/052](#) and [/056](#) Connectors.
- (c) ESCC Detail Specification No. [3401/062](#), Accessories for Circular Connectors [3401/044](#), [3401/052](#) and [3401/056](#).
- (d) ESCC Detail Specification No. [3401/066](#), Contacts, Electrical, Triax, Crimp for [3401/056](#) Connectors.
- (e) [MIL-STD-1560](#), Insert Arrangements for [MIL-DTL-38999](#), [MIL-DTL-27599](#), and SAE-AS29600 Series A Electrical Circular Connectors.
- (f) EIA-364.54, Magnetic Permeability Test Procedure for Electrical Connectors, Contacts, and Sockets.

TABLE 1(a) – RANGE OF COMPONENTS

Shell Style	Shell Size	Max. Weight (g) (1)		Mating & Unmating Axial Force (N)		Mating Torque Max. (Nm)	Unmating Torque		Tightening Torque for Mounting Nut Shell 07 Max. (Nm)
		Shell Type		Min.	Max.		Max. (Nm)	Min. (Nm)	
		00	07						
Receptacle	09	11	15	-	-	-	-	-	6
Receptacle	11	17	20	-	-	-	-	-	8
Receptacle	13	22	26	-	-	-	-	-	10
Receptacle	15	25	34	-	-	-	-	-	13
Receptacle	17	38	44	-	-	-	-	-	16
Receptacle	19	40	49	-	-	-	-	-	18
Receptacle	21	52	60	-	-	-	-	-	20
Receptacle	23	54	63	-	-	-	-	-	22
Receptacle	25	58	75	-	-	-	-	-	24
		Shell Types 06 & 66							
Plug	09	17		2	111	0.9	0.9	0.2	-
Plug	11	23		2	111	1.4	1.4	0.2	-
Plug	13	28		2	133	1.8	1.8	0.2	-
Plug	15	34		2	133	2.3	2.3	0.3	-
Plug	17	44		2	156	2.7	2.7	0.3	-
Plug	19	49		2	156	3.2	3.2	0.3	-
Plug	21	60		2	156	3.6	3.6	0.6	-
Plug	23	63		2	156	4.1	4.1	0.6	-
Plug	25	70		2	156	4.6	4.6	0.6	-

NOTES:

- Without contacts. See ESCC Detail Specifications Nos. [3401/058](#) and [3401/066](#) for contact weights.

TABLE 1(b) – MAXIMUM RATINGS

No.	Characteristics	Symbol	Maximum Rating	Unit
1	Working Voltage (Sea Level) (1) Service rating N Service rating M Service rating I Service rating II	U_R	250 325 450 575	Vrms
2	Operating Temperature Range	T_{op}	-65 to +200	°C
3	Storage Temperature Range	T_{stg}	-65 to +200	°C
4	Tightening Torque for Mounting Nut Shell 07	T_q	See Table 1(a)	-

NOTES:

- See Para. 4.5.4.2.

FIGURE 1 – PARAMETER DERATING INFORMATION

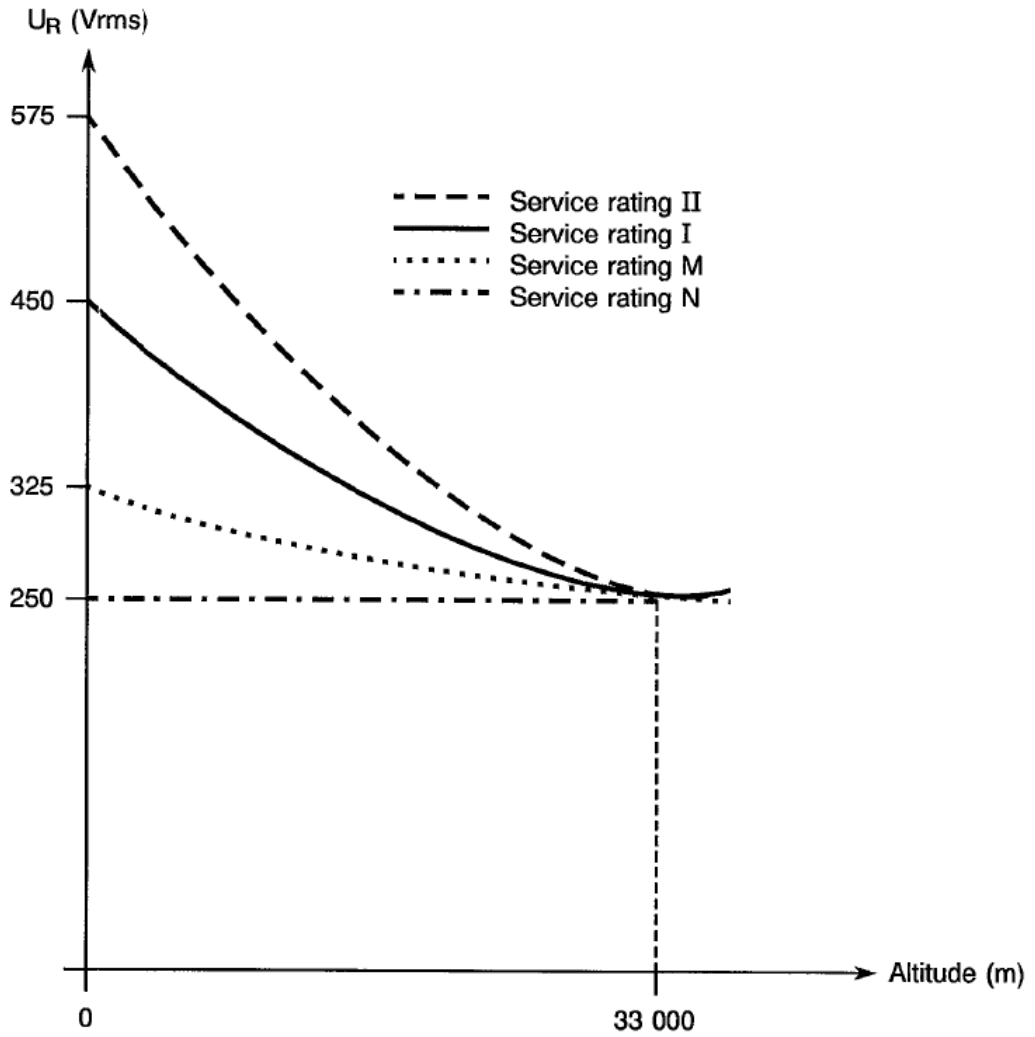

Working Voltage versus Altitude

FIGURE 2 – PHYSICAL DIMENSIONS

FIGURE 2(a) – RECEPTACLES AND PLUGS

SHELL TYPE 00: SQUARE FLANGE RECEPTACLE

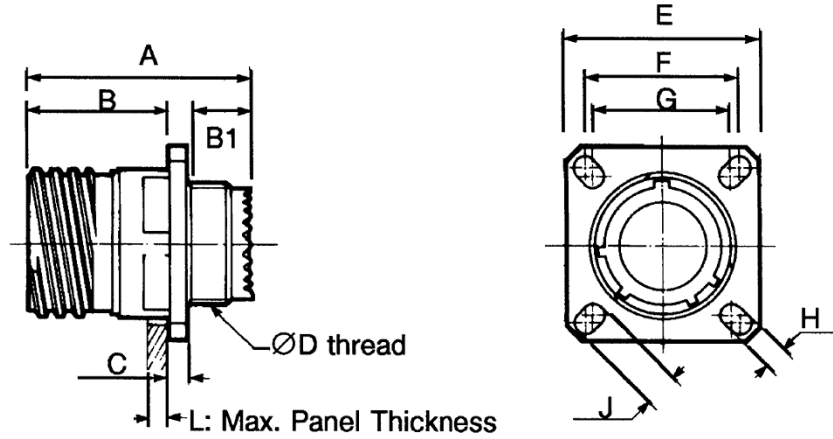

Shell Size	09		11		13		15		17		19		21		23		25	
	Min	Max	Min	Max	Min	Max	Min	Max	Min	Max	Min	Max	Min	Max	Min	Max	Min	Max
A	-	31.5	-	31.5	-	31.5	-	31.5	-	31.5	-	31.5	-	31.5	-	31.5	-	31.5
B1	7.12	-	7.12	-	7.12	-	7.12	-	7.12	-	7.12	-	7.12	-	7.12	-	7.12	-
B	-	20.9	-	20.9	-	20.9	-	20.9	-	20.9	-	20.9	-	20.1	-	20.1	-	20.1
C	-	2.5	-	2.5	-	2.5	-	2.5	-	2.5	-	2.5	-	3.2	-	3.2	-	3.2
ØD	M 12 × 1-6g		M 15 × 1-6g		M 18 × 1-6g		M 22 × 1-6g		M 25 × 1-6g		M 28 × 1-6g		M 31 × 1-6g		M 34 × 1-6g		M 37 × 1-6g	
E	23.5	24.1	25.9	26.5	28.3	28.9	30.7	31.3	33	33.6	36.2	36.8	39.4	40	42.6	43.2	45.7	46.3
F	18.16	18.36	20.52	20.72	22.91	23.11	24.51	24.71	26.87	27.07	29.26	29.46	31.65	31.85	34.83	35.03	38	38.2
G	14.99	15.19	18.16	18.36	20.52	20.72	22.91	23.11	24.51	24.71	26.87	27.07	29.26	29.46	31.65	31.85	34.83	35.03
H	3.05	3.45	3.05	3.45	3.05	3.45	3.05	3.45	3.05	3.45	3.05	3.45	3.05	3.45	3.71	4.11	3.71	4.11
J	5.29	5.69	4.73	5.13	4.73	5.13	4.19	4.59	4.73	5.13	4.73	5.13	4.73	5.13	5.95	6.35	5.95	6.35
L	-	2.5	-	2.5	-	2.5	-	2.5	-	2.5	-	2.5	-	2.5	-	2.5	-	2.5

NOTES:

1. All dimensions are in millimetres.

SHELL TYPES 06 & 66: PLUG

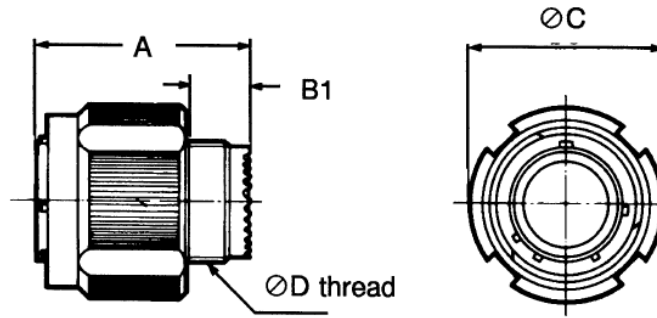

Shell Size	09		11		13		15		17		19		21		23		25	
	Min	Max	Min	Max	Min	Max	Min	Max	Min	Max	Min	Max	Min	Max	Min	Max	Min	Max
A	-	31	-	31	-	31	-	31	-	31	-	31	-	31	-	31	-	31
B1	7.12	-	7.12	-	7.12	-	7.12	-	7.12	-	7.12	-	7.12	-	7.12	-	7.12	-
ØC	-	21.8	-	25	-	29.4	-	32.5	-	35.7	-	38.5	-	41.7	-	44.85	-	48
ØD	M 12 × 1-6g		M 15 × 1-6g		M 18 × 1-6g		M 22 × 1-6g		M 25 × 1-6g		M 28 × 1-6g		M 31 × 1-6g		M 34 × 1-6g		M 37 × 1-6g	

SHELL TYPE 07: SINGLE HOLE MOUNTING RECEPTACLE

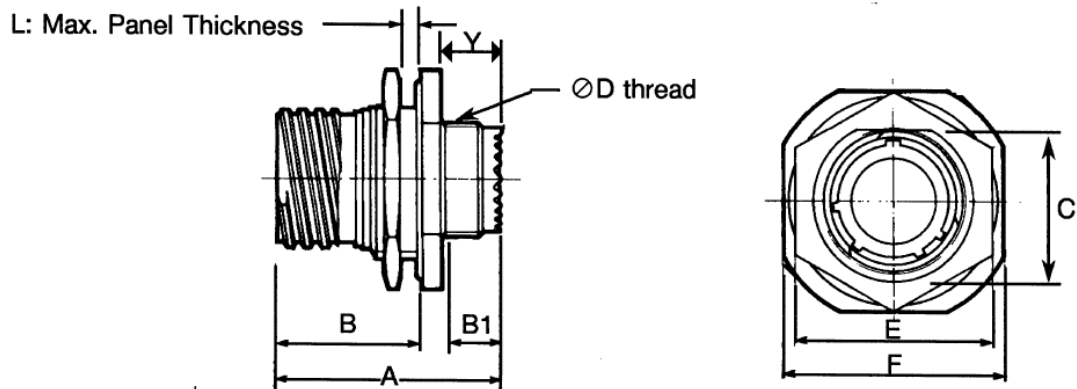

Shell Size	09		11		13		15		17		19		21		23		25	
	Min	Max	Min	Max	Min	Max	Min	Max	Min	Max	Min	Max	Min	Max	Min	Max	Min	Max
A	-	32.5	-	32.5	-	32.5	-	32.5	-	32.5	-	32.5	-	32.5	-	32.5	-	32.5
B1	7.12	7.62	7.12	7.62	7.12	7.62	7.12	7.62	7.12	7.62	7.12	7.62	7.12	7.62	7.12	7.62	7.12	7.62
B	-	22.6	-	22.6	-	22.6	-	22.6	-	22.6	-	22.6	-	22.6	-	22.6	-	22.6
C	16.38	16.63	18.92	19.17	23.67	23.92	26.82	27.07	30	30.25	33.17	33.42	36.35	36.6	39.52	39.77	42.7	42.95
ØD	M 12 × 1-6g		M 15 × 1-6g		M 18 × 1-6g		M 22 × 1-6g		M 25 × 1-6g		M 28 × 1-6g		M 31 × 1-6g		M 34 × 1-6g		M 37 × 1-6g	
E	-	24	-	27	-	32	-	36	-	37	-	41	-	46	-	50	-	51.23
F	26.6	27.4	31.4	32.2	34.5	35.3	37.7	38.5	40.9	41.7	45.6	46.4	48.8	49.6	52	52.8	55.2	56
L	-	3.2	-	3.2	-	3.2	-	3.2	-	3.2	-	3.2	-	3.2	-	3.2	-	3.2
Y	6.54	7.54	6.54	7.54	6.36	7.36	6.36	7.36	6.36	7.36	5.57	6.57	5.57	6.57	5.57	6.57	5.57	6.57

NOTES:

1. All dimensions are in millimetres.

FIGURE 2(b) – HIGH DENSITY CONTACT ARRANGEMENTS – FRONT VIEW MALE INSERT

9-35

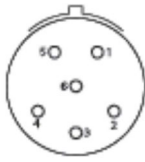

6#22D

11-35



13#22D

13-35

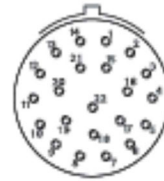

22#22D

15-35



37#22D

17-35

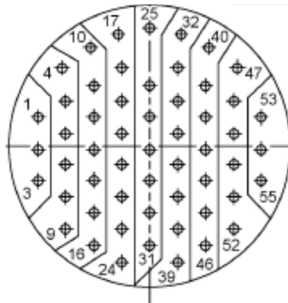

55#22D

19-35

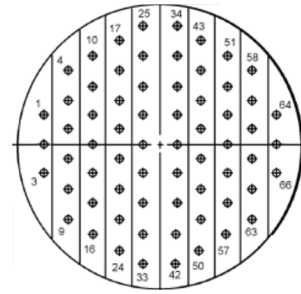

66#22D

21-35

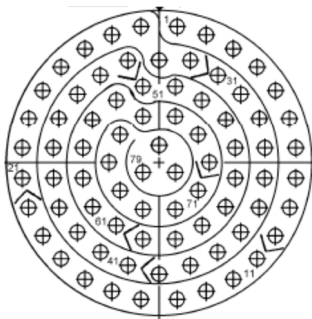

79#22D

23-35

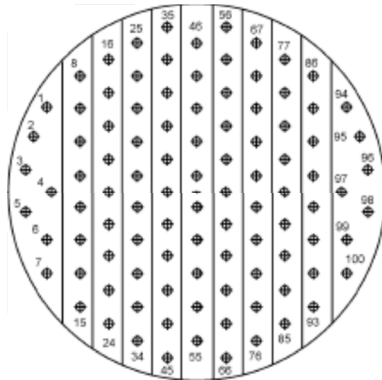

100#22D

25-35

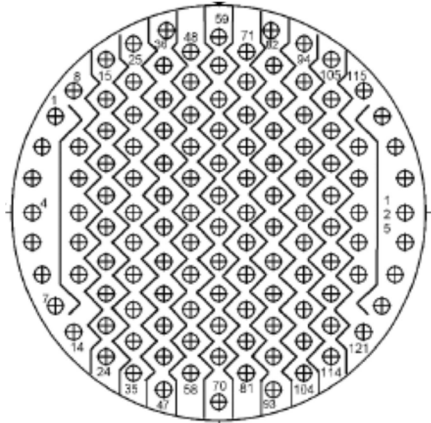

128#22D

NOTES:

1. Contact locations and identifications are in conformity with [MIL-STD-1560](#).
2. Both sides of the inserts shall be marked.

FIGURE 2(b) – STANDARD CONTACT ARRANGEMENTS – FRONT VIEW MALE INSERT

9-98

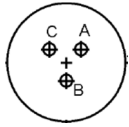

3#20

11-04

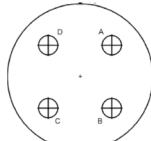

4#20

11-05

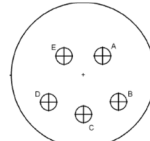

5#20

11-98

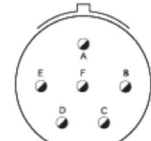

6#20

11-99

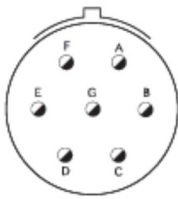

7#20

13-08

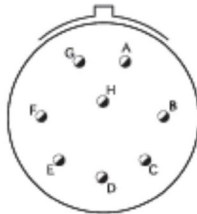

8#20

13-98

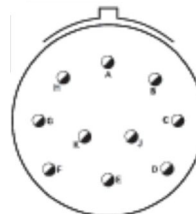

10#20

15-18

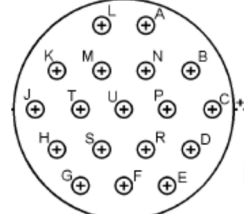

18#20

15-19

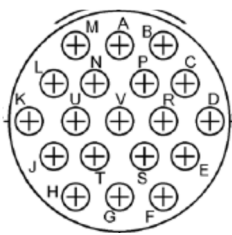

19#20

17-26

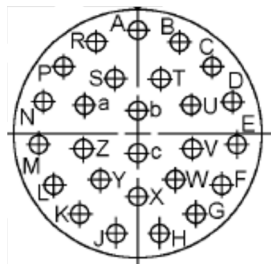

26#20

19-32

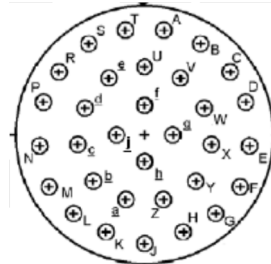

32#20

21-41

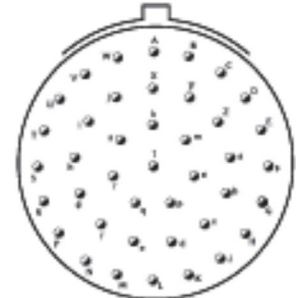

41#20

23-53

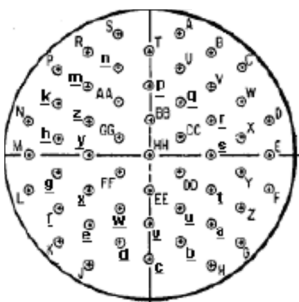

53#20

23-55

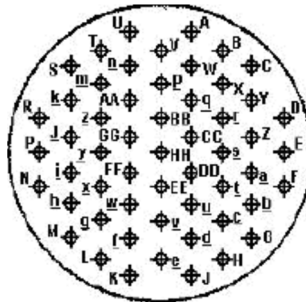

55#20

25-61

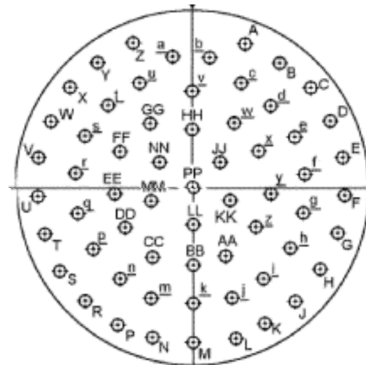

61#20

NOTES:

1. Contact locations and identifications are in conformity with [MIL-STD-1560](#).
2. Both sides of the inserts shall be marked.

FIGURE 2(b) – SPECIAL CONTACT ARRANGEMENTS – FRONT VIEW MALE INSERT

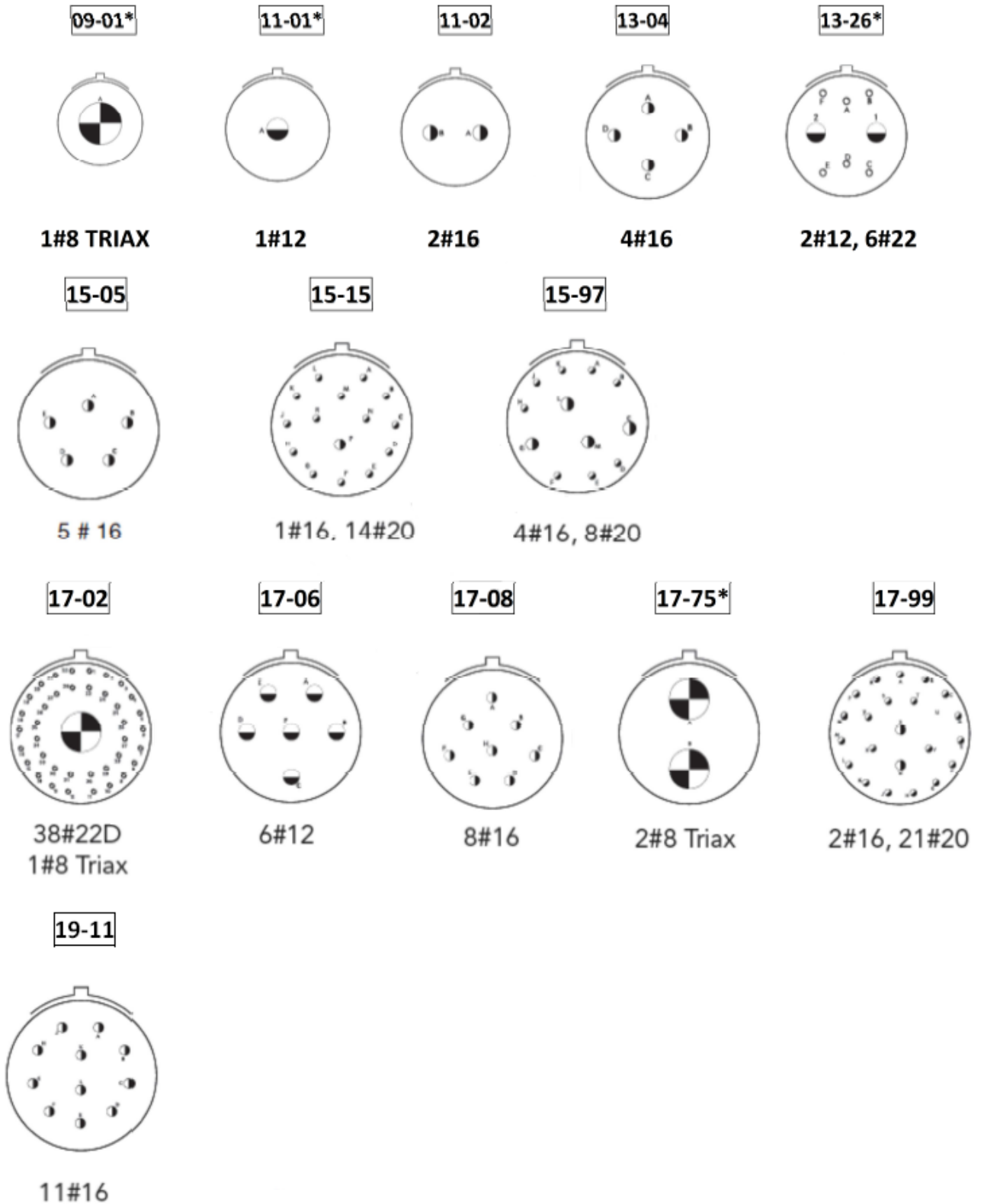

NOTES:

1. Contact locations and identifications are in conformity with [MIL-STD-1560](#) except those identified with *.
2. Both sides of the inserts shall be marked.

FIGURE 2(b) – SPECIAL CONTACT ARRANGEMENTS – FRONT VIEW MALE INSERT

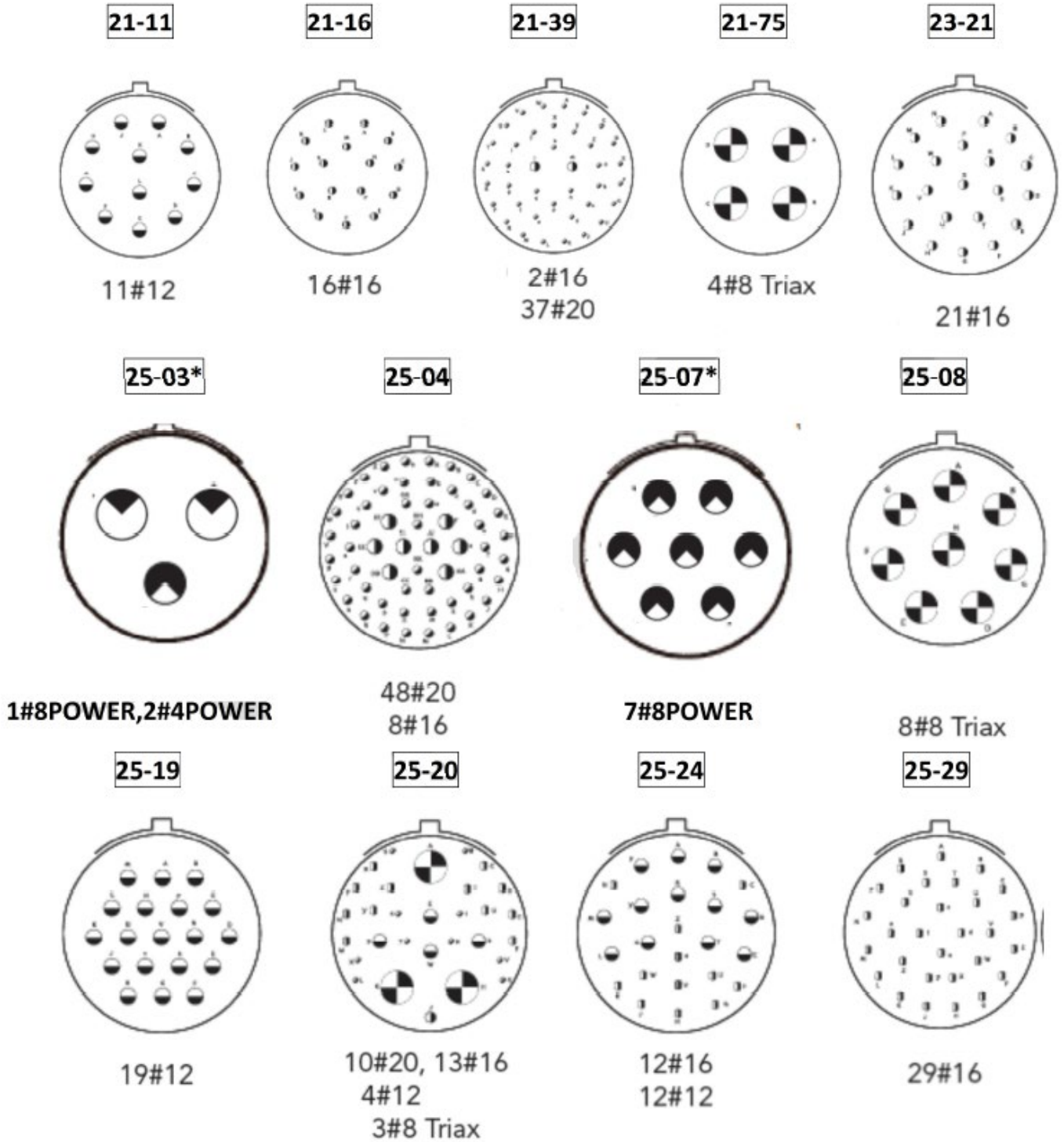

NOTES:

1. Contact locations and identifications are in conformity with MIL-STD-1560 except those identified with *.
2. Both sides of the inserts shall be marked.

FIGURE 2(b) – SPECIAL CONTACT ARRANGEMENTS – FRONT VIEW MALE INSERT

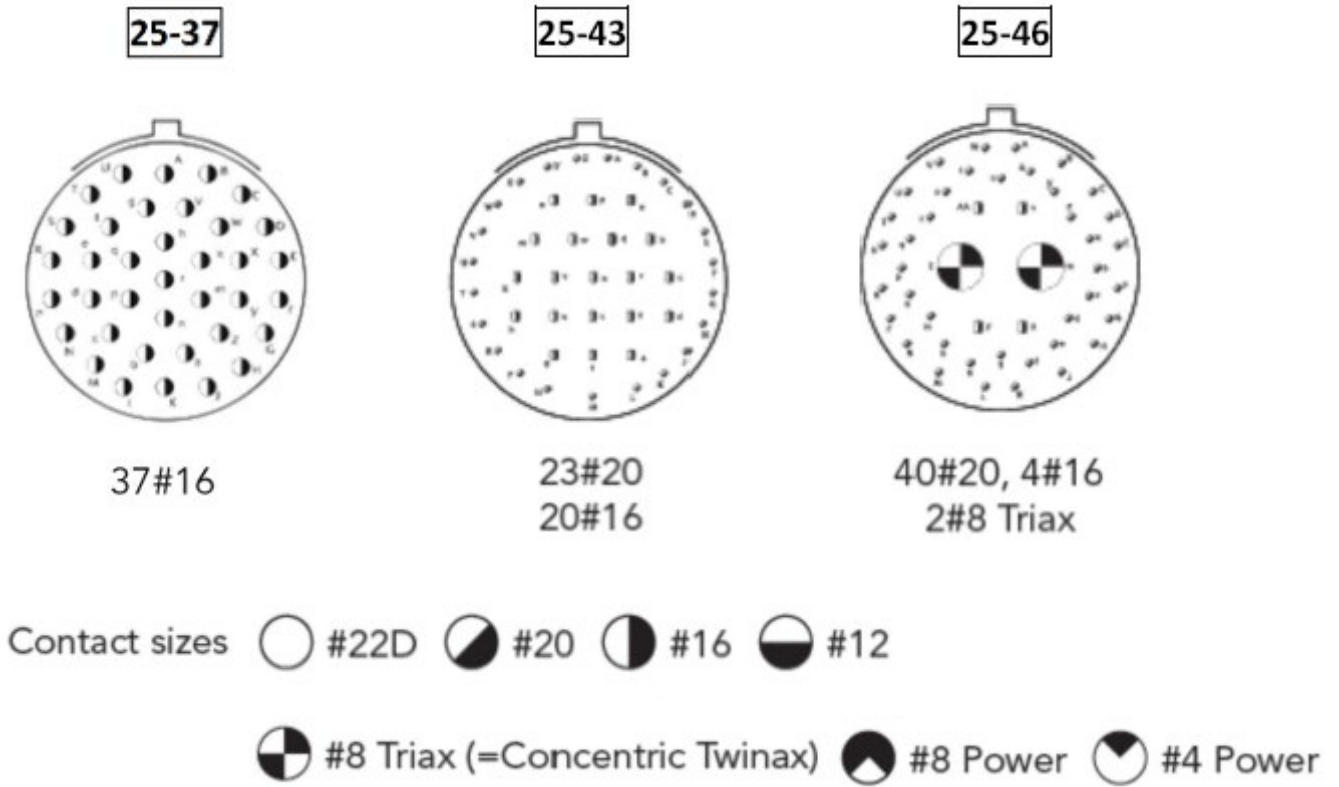

NOTES:

1. Contact locations and identifications are in conformity with [MIL-STD-1560](#).
2. Both sides of the inserts shall be marked.

FIGURE 2(c) – CLOCKING POSITIONS

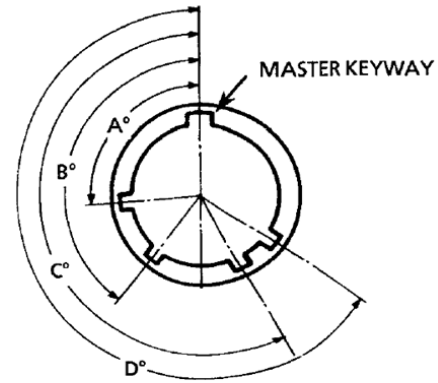

NOTES:

1. The clocking position is determined by the different angles of the secondary keyways, the insert being always in the same position with respect to the master keyway position, which is fixed.

Receptacle front end view

Shell Size	Angles	Clocking Positions					
		N	A	B	C	D	E
09	A°	105	102	80	35	64	91
	B°	140	132	118	140	155	131
	C°	215	248	230	205	234	197
	D°	265	320	312	275	304	240
11	A°	95	113	90	53	119	51
	B°	141	156	145	156	146	141
	C°	208	182	195	220	176	184
	D°	236	292	252	255	298	242
13	A°	95	113	90	53	119	51
	B°	141	156	145	156	146	141
	C°	208	182	195	220	176	184
	D°	236	292	252	255	298	242
15	A°	95	113	90	53	119	51
	B°	141	156	145	156	146	141
	C°	208	182	195	220	176	184
	D°	236	292	252	255	298	242
17	A°	80	135	49	66	62	79
	B°	142	170	169	140	145	153
	C°	196	200	200	200	180	197
	D°	293	310	244	257	280	272
19	A°	80	135	49	66	62	79
	B°	142	170	169	140	145	153
	C°	196	200	200	200	180	197
	D°	293	310	244	257	280	272
21	A°	80	135	49	66	62	79
	B°	142	170	169	140	145	153
	C°	196	200	200	200	180	197
	D°	293	310	244	257	280	272
23	A°	80	135	49	66	62	79
	B°	142	170	169	140	145	153
	C°	196	200	200	200	180	197
	D°	293	310	244	257	280	272
25	A°	80	135	49	66	62	79
	B°	142	170	169	140	145	153
	C°	196	200	200	200	180	197
	D°	293	310	244	257	280	272

3 TERMS, DEFINITIONS, ABBREVIATIONS, SYMBOLS AND UNITS

For the purpose of this specification, the terms, definitions, abbreviations, symbols and units specified in ESCC Basic Specification No. 21300 shall apply.

4 REQUIREMENTS

4.1 GENERAL

The complete requirements for procurement of the connectors specified herein are stated in this specification and ESCC Generic Specification No. 3401. Deviations from the Generic Specification, applicable to this specification only, are listed in Para. 4.2.

Deviations from the applicable Generic Specification and this Detail Specification, formally agreed with specific Manufacturers on the basis that the alternative requirements are equivalent to the ESCC requirements and do not affect the components' reliability, are listed in the appendices attached to this specification.

4.2 DEVIATIONS FROM GENERIC SPECIFICATION

4.2.1 Deviations from Special In-process Controls

None.

4.2.2 Deviations from Final Production Tests (Chart II)

(a) Para. 9.5, Magnetism Level: Not applicable. Instead, a magnetic permeability test shall be performed in accordance with EIA-364-54. The magnetic permeability of assembled connectors (with contacts and accessories as applicable) shall not exceed $2 \times \mu_0$.

The test shall be performed on 1 sample per shell size.

4.2.3 Deviations from Burn-in and Electrical Measurements (Chart III)

Chart III is not applicable.

4.2.4 Deviations from Qualification Tests (Chart IV)

(a) Para. 9.11.2, Sinusoidal Vibration Testing:

- 10-55Hz at 8.25mm double amplitude displacement.
- 56-2000Hz at 50g.
- 1 cycle (10-2000-10 Hz) per axis at a sweep rate of 1 octave per minute.

(b) Para. 9.11.3, Random Vibration Testing:

- 20-100Hz at + 6dB per octave.
- 100-2000Hz, constant at $1.0g^2/Hz$.
- 3 axes.
- 7 minutes per axis.

(c) Para. 9.12.1, Shock: 75g, 11 milliseconds, half sine wave.

(d) Para. 9.24, Jackscrew Retention: Not applicable.

(e) Para. 9.31, Solderability: Not applicable.

4.2.5 Deviations from Lot Acceptance Tests (Chart V)

(a) Para. 9.31, Solderability: Not applicable.

4.3 MECHANICAL REQUIREMENTS

4.3.1 Dimension Check

The dimensions of the connectors specified herein shall be verified in accordance with the requirements set out in Para. 9.6 of ESCC Generic Specification No. [3401](#) and shall conform to those shown in Figure 2 of this specification.

4.3.2 Weight

The maximum weight of the connectors specified herein, without contacts, shall be as specified in Table 1(a).

4.3.3 Contact Capability

As specified in ESCC Detail Specifications Nos. [3401/058](#) and [3401/066](#).

4.3.4 Contact Retention (In Insert)

As specified in ESCC Detail Specifications Nos. [3401/058](#) and [3401/066](#). For the 09-01 arrangement, the specified backshell in ESCC Detail Specification No. [3401/062](#) shall be used.

4.3.5 Mating and Unmating Forces

The forces applied for mating and unmating of the connectors (axial and torque) shall conform to the values specified in Table 1(a).

4.3.6 Insert Retention (In Shell)

Connector inserts shall withstand a pressure of 53.7N/cm² without being dislodged from the shell. For the 09-01 arrangement, the specified backshell in ESCC Detail Specification No. [3401/062](#) shall be used.

4.3.7 Jackscrew Retention

Not applicable.

4.3.8 Contact Insertion and Withdrawal Forces

As specified in ESCC Detail Specifications Nos. [3401/058](#) and [3401/066](#).

4.3.9 Engagement and Separation Forces

As specified in ESCC Detail Specifications Nos. [3401/058](#) and [3401/066](#).

4.3.10 Oversize Pin Exclusion

As specified in ESCC Detail Specifications Nos. [3401/058](#) and [3401/066](#).

4.3.11 Probe Damage

As specified in ESCC Detail Specifications Nos. [3401/058](#) and [3401/066](#).

4.3.12 Solderability

Not applicable.

4.4 MATERIALS AND FINISHES

The materials and finishes shall be as specified herein. Where a definite material is not specified, a material which will enable the connectors specified herein to meet the performance requirements of this specification shall be used. Acceptance or approval of any constituent material does not guarantee acceptance of the finished product.

4.4.1 Shell, Coupling Ring and Nuts

The shell, coupling ring and nuts shall be made of aluminium alloy, dull low reflective electroless nickel plated.

4.4.2 Inserts

Bonded sandwich: Silicone/thermosetting or thermoplastic insert/silicone. For the 09-01 arrangement, the insert shall be made of a thermoplastic material.

4.4.3 Contacts

As specified in ESCC Detail Specifications Nos. [3401/058](#) and [3401/066](#).

4.4.4 Contact Retaining Clip

The retaining clip shall be made of beryllium copper. Not applicable to the 09-01 arrangement.

4.4.5 Guiding and Locking Devices

Not applicable.

4.4.6 Magnetism Level

Not applicable.

4.5 MARKING

4.5.1 General

The marking of all components delivered to this specification shall be in accordance with the requirements of ESCC Basic Specification No. [21700](#) and the following paragraphs. Each component shall be marked in respect of:

- (a) Contact Identification.
- (b) The ESCC Component Number.
- (c) Characteristics.
- (d) Traceability information.

4.5.2 Contact Identification

Contact identification shall be marked in accordance with Figure 2(b).

4.5.3 The ESCC Component Number

The ESCC Component Number shall be constituted and marked as follows:

Example: 340105601B

- Detail Specification Number: 3401056
- Type Variant (Note 1): 01
- Testing Level: B

NOTES:

1. Marking of the Type Variant is mandatory. No further reference to type variants is made in this specification.

4.5.4 Characteristics

The characteristics to be marked in the following order of precedence are:

- (a) Shell Type.
- (b) Contact arrangement.
- (c) Type of contact.
- (d) Clocking position.
- (e) Contact Information.

The information shall be constituted and marked as follows:

(example): 00 - 19-32 P A - L

- Shell Type: 00
- Contact arrangement: 19-32
- Type of contact: P
- Clocking position: A
- Contact information: L

4.5.4.1 *Shell Type*

The shell type shall be indicated by the numbers specified hereafter:

Code Number	Shell Type
00	Square flange receptacle
06	Plug with RFI grounding spring
07	Single hole mounting receptacle
66	Plug with mirror image contact numbering with RFI grounding spring (1)

NOTES:

1. Example of "Plug with mirror image contact numbering" is provided below. To be used on the appropriate side of a feedthrough receptacle.

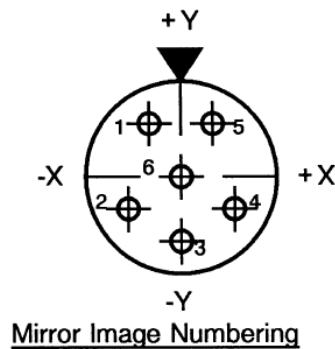
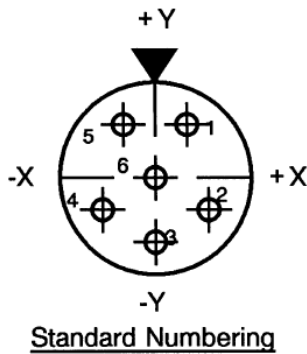

4.5.4.2 Contact Arrangements

The number of contacts shall be as shown in Figure 2(b) and contact arrangements shall be indicated by the codes specified hereafter.

Code	Service Rating	Code	Service Rating
09-01	Not applicable	19-11	II
09-35	M	19-32	I
09-98	I	19-35	M
11-01	II	21-11	I
11-02	I	21-16	II
11-04	I	21-35	M
11-05	I	21-39	I
11-35	M	21-41	I
11-98	I	21-75	M
11-99	I	23-21	II
13-04	I	23-35	M
13-08	I	23-53	I
13-26	M	23-55	I
13-35	M	25-03	I
13-98	I	25-04	I
15-05	II	25-07	I
15-15	I	25-08	M
15-18	I	25-19	I
15-19	I	25-20	N
15-35	M	25-24	II
15-97	I	25-29	I
17-02	M	25-37	II
17-06	I	25-35	M
17-08	II	25-43	I
17-26	I	25-46	I
17-35	M	25-61	I
17-75	M		
17-99	I		

4.5.4.3 Type of Contact

The contact type shall be indicated by the following code letters.

Code Letter	Contact Type
P	Male
S	Female

4.5.4.4 Clocking Position

Clocking positions are as shown in Figure 2(c) and shall be designated by the following code letters: A, B, C, D and E. Code letter N indicates the standard clocking position.

4.5.4.5 Contact Information

L = connector ordered without contacts (without an L = connector delivered with contacts).

This information shall be marked on the packaging and is not marked on the connector.

Contacts shall be obtained from the same Manufacturer as supplied the connector in which they are to be mounted and this shall be verified before assembly.

4.5.5 Traceability Information

Traceability information shall be marked in accordance with the requirements of ESCC Basic Specification No. [21700](#).

4.5.6 Marking of Small Components

Where it is considered that a component is too small to accommodate the marking as specified above, as much as space permits shall be marked. The order of precedence shall be as specified in Para. 4.5.1. The marking information in full shall accompany each component in its primary package.

4.6 ELECTRICAL MEASUREMENTS

4.6.1 Electrical Measurements at Room Temperature

The parameters to be measured in respect of electrical characteristics are scheduled in Table 2. Unless otherwise specified, these measurements shall be performed at $T_{amb} = +22 \pm 3^{\circ}\text{C}$.

4.6.2 Electrical Measurements at High and Low Temperatures (Table 3)

Not applicable.

4.6.3 Circuits for Electrical Measurements (Figure 4)

Not applicable.

4.7 BURN-IN AND ELECTRICAL MEASUREMENTS (TABLES 4 AND 5)

Not applicable.

TABLE 2 – ELECTRICAL MEASUREMENTS AT ROOM TEMPERATURE

No.	Characteristics	Symbol	Spec. and/or Test Method	Test Condition	Limits		Unit
					Min	Max	
1	Insulation Resistance	R _i	ESCC No. 3401 Para. 9.1.1.1	Para. 9.1.1.1	10000	-	MΩ
2	Voltage Proof Leakage Current Service Rating II Service Rating I Service Rating M Service Rating N	I _L	ESCC No. 3401 Para. 9.1.1.2	2300Vrms 1800Vrms 1300Vrms 1000Vrms	-	2	mA
3	Mated Shell Conductivity (Voltage Drop)	V _d	ESCC No. 3401 Para. 9.1.1.4	Para. 9.1.1.4 (Note 1)	-	1	mV

NOTES:

1. Applicable to mated connectors with grounding option.

TABLES 3, 4 AND 5

Not applicable.

4.8 ENVIRONMENTAL AND ENDURANCE TESTS (CHARTS IV AND V OF ESCC GENERIC SPECIFICATION No. 3401)

4.8.1 Measurements and Inspections on Completion of Environmental Tests

The parameters to be measured and inspections to be performed on completion of environmental testing shall be those specified in Table 6. Unless otherwise specified, the measurements shall be performed at T_{amb} = +22 ±3°C.

4.8.2 Measurements and Inspections at Intermediate Points during Endurance Tests

Not applicable.

4.8.3 Measurements and Inspections on Completion of Endurance Tests

The parameters to be measured and inspections to be performed on completion of endurance tests shall be those specified in Table 6. Unless otherwise specified, the measurements shall be performed at T_{amb} = +22 ±3°C.

4.8.4 Conditions for Operating Life Test (Part of Endurance Testing)

Not applicable.

4.8.5 Electrical Circuits for Operating Life Test

Not applicable.

4.8.6 Conditions for High Temperature Storage Test (Part of Endurance Testing)

The requirements for the high temperature storage test are specified in Section 9 of ESCC Generic Specification No. 3401. The conditions for high temperature storage testing shall be the maximum storage temperature specified in Table 1(b) of this specification.

TABLE 6 – MEASUREMENTS AND INSPECTIONS ON COMPLETION OF ENVIRONMENTAL AND ENDURANCE TESTS

No.	ESCC Generic No. 3401		Measurements and Inspections		Symbol	Limits		Unit
	Environmental and Endurance Tests (1)	Test Method and Conditions	Identification	Conditions		Min	Max	
01	Seal Test	Para. 9.9	ESCC 3401 Para. 9.9	-	-	Not applicable		
02	Wiring	Para. 9.10	ESCC 3401/058	-	-	-	-	
03	Vibration	Para. 9.11 & Para. 4.2.4 of this spec.	Initial Measurements Coupling Screw(s) Unlocking Torque Final Measurements Full Engagement Coupling Screw(s) Unlocking Torque Drift Visual Examination	-	-	Not applicable		
			Full Engagement Visual Examination	-	-	-	-	
04	Shock or Bump	Para. 9.12 & Para. 4.2.4 of this spec.	Dry Heat Insulation Resistance Low Air Pressure Voltage Proof Leakage Curr. Damp Heat Insulation Resistance Final Measurements External Visual Inspection Insulation Resistance Voltage Proof Leakage Curr.	Table 2 Item 1 250Vrms Immediately after test Table 2 Item 1 After 1-24 hrs Recovery ESCC 3401 Para. 9.7	Ri I _L Ri - Ri I _L	1000 Table 2 Item 2 100 ESCC 3401 Para. 9.7 Table 2 Item 1 Table 2 Item 2	-	MΩ
05	Climatic Sequence	Para. 9.13	Thickness	-	-	ESCC 3401/058 or 3401/066		
06	Plating Thickness	Para. 9.14	ESCC 3401 Para. 9.15	-	-	ESCC 3401 Para. 9.15		
07	Joint Strength	Para. 9.15	Visual Examination Insulation Resistance Voltage Proof Leakage Curr.	-	-	-	-	
08	Rapid Change of Temperature	Para. 9.16	Contact Displacement	-	-	ESCC 3401 Para. 9.17		
09	Contact Retention (In Insert)	Para. 9.17 & Para. 4.3.4 of spec.						

No.	ESCC Generic No. 3401		Measurements and Inspections		Symbol	Limits		Unit
	Environmental and Endurance Tests (1)	Test Method and Conditions	Identification	Conditions		Min	Max	
10	Endurance	Para. 9.18	Initial Measurements Mating/Unmating Forces Low Level Contact Resist. Mated Shell Conductivity Final Measurements Visual Examination Mating/Unmating Forces Low Level Contact Resistance Drift Mated Shell Conductivity Insulation Resistance Voltage Proof Leakage Curr.	- ESCC 3401/058 or 3401/066 Table 2 Item 3 - - ESCC 3401/058 or 3401/066 Table 2 Item 3 Table 2 Item 1 Table 2 Item 2	F Rcl Vd - F ΔRcl Vd Ri I _L	 Para. 4.3.5 of this spec. Record Values Table 2 Item 3 - - Para. 4.3.5 of this spec. ESCC 3401/058 or 3401/066 Table 2 Item 3 Table 2 Item 1 Table 2 Item 2		
11	Permanence of Marking	Para. 9.19	As applicable	-	-	-	-	
12	Mating/Unmating Forces	Para. 9.20	Force	-	F	Para. 4.3.5 of this spec.		
13	High Temperature Storage	Para. 9.21	Initial Measurements Low Level Contact Resist. Mated Shell Conductivity Final Measurements Visual Examination Mating/Unmating Forces Low Level Contact Resistance Drift Rated Current Contact Resistance Mated Shell Conductivity Insulation Resistance Voltage Proof Leakage Curr. Contact Retention (In Insert)	ESCC 3401/058 or 3401/066 Table 2 Item 3 - - ESCC 3401/058 or 3401/066 ESCC 3401/058 or 3401/066 Table 2 Item 3 Table 2 Item 1 Table 2 Item 2 Para. 4.3.4 of this spec.	Rcl Vd - F ΔRcl Rcr Vd Ri I _L -	 Record Values Table 2 Item 3 - - Para. 4.3.5 of this spec. ESCC 3401/058 or 3401/066 ESCC 3401/058 or 3401/066 Table 2 Item 3 Table 2 Item 1 Table 2 Item 2 ESCC 3401 Para. 9.17		
14	Corrosion	Para. 9.22	Visual Examination	-	-	-	-	
15	Insert Retention (In Shell)	Para. 9.23 & Para. 4.3.6 of this spec.	Visual Examination	-	-	Para. 4.3.6 of this spec.		
16	Jackscrew Retention	Para. 9.24 & Para. 4.3.7 of this spec.	Visual Examination	-	-	Not applicable		
17	High Temperature Measurements	Para. 9.25	Insulation Resistance	Table 2 Item 1	Ri	500	-	MΩ

No.	ESCC Generic No. 3401		Measurements and Inspections		Symbol	Limits		Unit
	Environmental and Endurance Tests (1)	Test Method and Conditions	Identification	Conditions		Min	Max	
18	Overload Test	Para. 9.26	Internal Temperature Rated Current Contact Resistance Mated Shell Conductivity Insulation Resistance Voltage Proof Leakage Curr.	- ESCC 3401/058 or 3401/066 Table 2 Item 3 Table 2 Item 1 Table 2 Item 2	T Rcr Vd Ri I _L	-	+100 ESCC 3401/058 or 3401/066 Table 2 Item 3 Table 2 Item 1 Table 2 Item 2	°C
19	Maintenance Aging	Para. 9.27	Visual Examination Contact Retention Contact Insertion & Withdrawal Forces	- Para. 4.3.4 of this spec. Para. 4.3.8 of this spec.	- - -	-	- ESCC 3401 Para. 9.17 Para. 4.3.8 of this spec.	
20	Engage/Separation Forces	Para. 9.28 & Para. 4.3.9 of this spec.	Force	-	F	Para. 4.3.9 of this spec.		
21	Oversize Pin Exclusion	Para. 9.29 & Para. 4.3.10 of this spec.	-	-	-	ESCC 3401 Para. 9.29		
22	Probe Damage	Para. 9.30 & Para. 4.3.11 of this spec.	Contact Separation Force	Para. 4.3.9 of this spec.	F	Para. 4.3.9 of this spec.		
23	Solderability	Para. 9.31 & Para. 4.3.12 of this spec.	-	-	-	Para. 4.3.12 of this spec.		

NOTES:

1. The tests in this Table refer to either Chart IV or V and shall be used as applicable.