



CONNECTORS, RF COAXIAL
ESCC Generic Specification No. 3402

Issue 4	June 2019
---------	-----------



LEGAL DISCLAIMER AND COPYRIGHT

European Space Agency, Copyright © 2019. All rights reserved.

The European Space Agency disclaims any liability or responsibility, to any person or entity, with respect to any loss or damage caused, or alleged to be caused, directly or indirectly by the use and application of this ESCC publication.

This publication, without the prior permission of the European Space Agency and provided that it is not used for a commercial purpose, may be:

- copied in whole, in any medium, without alteration or modification.
- copied in part, in any medium, provided that the ESCC document identification, comprising the ESCC symbol, document number and document issue, is removed.

DOCUMENTATION CHANGE NOTICE

(Refer to <https://escies.org> for ESCC DCR content)

DCR No.	CHANGE DESCRIPTION
1257	Specification upissued to incorporate changes per DCR.

TABLE OF CONTENTS

1	INTRODUCTION	8
1.1	SCOPE	8
1.2	APPLICABILITY	8
2	APPLICABLE DOCUMENTS	8
2.1	ESCC SPECIFICATIONS	8
2.2	OTHER (REFERENCE) DOCUMENTS	8
2.3	ORDER OF PRECEDENCE	9
3	TERMS, DEFINITIONS, ABBREVIATIONS, SYMBOLS AND UNITS	9
4	REQUIREMENTS	9
4.1	GENERAL	9
4.1.1	Specifications	9
4.1.2	Conditions and Methods of Test	9
4.1.3	Manufacturer's Responsibility for Performance of Tests and Inspections	9
4.1.4	Inspection Rights	9
4.1.5	Pre-encapsulation Inspection	9
4.2	QUALIFICATION APPROVAL REQUIREMENTS ON A MANUFACTURER	10
4.3	DELIVERABLE COMPONENTS	10
4.3.1	Lot Failure	10
4.3.2	Testing and Lot Acceptance Levels	10
4.4	MARKING	11
4.5	MATERIALS AND FINISHES	11
5	PRODUCTION CONTROL	11
5.1	GENERAL	11
5.2	SPECIAL IN-PROCESS CONTROLS	11
5.2.1	Contact Engagement and Separation Forces	11
5.2.2	External Visual Inspection	11
5.2.3	Gold Plate Porosity	11
5.2.4	Plating Thickness	12
5.2.5	Crimping Capability	12
5.2.6	Solderability	12
5.3	DOCUMENTATION	12
6	FINAL PRODUCTION TESTS	14
6.1	GENERAL	14
6.2	TEST METHODS AND CONDITIONS	14
6.3	FAILURE CRITERIA	14
6.3.1	Parameter Limit Failure	14
6.3.2	Other Failures	14

6.4	FAILED COMPONENTS	14
6.5	LOT FAILURE	14
6.5.1	Lot Failure during 100% Testing	14
6.5.2	Lot Failure during Sample Testing	15
6.6	DOCUMENTATION	15
7	BURN-IN AND ELECTRICAL MEASUREMENTS (CHART III)	15
8	QUALIFICATION APPROVAL AND LOT ACCEPTANCE TESTS	15
8.1	QUALIFICATION TESTING	15
8.1.1	General	15
8.1.2	Distribution within the Qualification Test Lot	15
8.2	LOT ACCEPTANCE TESTING	16
8.2.1	General	16
8.2.2	Distribution within the Sample Lot for Lot Acceptance Testing	16
8.2.3	Lot Acceptance Level 3 Testing (LA3)	16
8.2.4	Lot Acceptance Level 2 Testing (LA2)	16
8.2.5	Lot Acceptance Level 1 Testing (LA1)	16
8.3	FAILURE CRITERIA	17
8.3.1	Environmental and Mechanical Test Failures	17
8.3.2	Electrical Failures	17
8.3.3	Other Failures	17
8.4	FAILED COMPONENTS	17
8.5	LOT FAILURE	17
8.6	DOCUMENTATION	17
9	TEST METHODS AND PROCEDURES	21
9.1	INSULATION RESISTANCE	21
9.2	VOLTAGE PROOF	21
9.3	CONTACT ENGAGEMENT AND SEPARATION FORCES	21
9.4	COUPLING PROOF TORQUE	21
9.5	MATING AND UNMATING FORCES	22
9.5.1	Bayonet and Screw Coupling	22
9.5.2	Push-pull Coupling	22
9.5.3	Blind-mate, Slide-on Coupling (Female Connector Only)	22
9.6	CENTRE CONTACT RETENTION	22
9.7	SEAL TEST	22
9.7.1	Hermetically Sealed Connectors	22
9.7.2	Leakage (Barrier-sealed Connectors)	23
9.7.3	Leakage (Panel-sealed Connectors)	23

9.8	EXTERNAL VISUAL INSPECTION	23
9.9	CONTACT RESISTANCE	23
9.9.1	Method A - Using Separate Power Supplies and Meters	23
9.9.2	Method B - Using Integrated Power Supplies and Meters with a 4 Terminal Bridge Arrangement	23
9.9.2.1	Equipment	23
9.9.2.2	Centre Contacts	23
9.9.2.3	Outer Contacts	24
9.10	VIBRATION	26
9.10.1	Mounting	26
9.10.2	Procedure	26
9.10.3	Measurement during Vibration	26
9.10.4	Final Measurements	26
9.11	SHOCK OR BUMP	26
9.11.1	Shock	26
9.11.1.1	Mounting	26
9.11.1.2	Procedure	27
9.11.1.3	Visual Examination	27
9.11.2	Bump	27
9.11.2.1	Mounting	27
9.11.2.2	Procedure	27
9.11.2.3	Visual Examination	27
9.12	RAPID CHANGE OF TEMPERATURE	27
9.12.1	Initial Measurements	27
9.12.2	Procedure	27
9.12.3	Recovery and Final Measurements	27
9.13	CLIMATIC SEQUENCE	28
9.13.1	Initial Measurements	28
9.13.2	Dry Heat	28
9.13.3	Damp Heat, Accelerated, First Cycle	28
9.13.4	Cold Test	28
9.13.5	Low Air Pressure	28
9.13.6	Damp Heat, Accelerated, Remaining Cycles	28
9.13.7	Final Measurements	28
9.14	CABLE RETENTION FORCE	29
9.15	CABLING AND CRIMPING CAPABILITY (CABLE CONNECTORS ONLY)	29
9.16	VOLTAGE STANDING WAVE RATIO (VSWR) OR REFLECTION COEFFICIENT	29
9.17	CORONA LEVEL	29

9.18	ENDURANCE	30
9.19	RF INSERTION LOSS	30
9.20	CORROSION	30
9.21	RESIDUAL MAGNETISM	30
9.22	SOLDERING PROOF (SOLDER-TYPE CONNECTORS ONLY)	30
9.23	RF LEAKAGE (SEMI-RIGID CABLE CONNECTORS ONLY)	31
9.23.1	For RF Leakage \geq -100dB	31
9.23.2	For RF Leakage $<$ -100dB (susceptibility)	31
9.24	HIGH TEMPERATURE STORAGE	31
9.25	DIMENSION CHECK	31
9.26	CHANGE OF TEMPERATURE	31
9.27	PERMANENCE OF MARKING	32
9.28	SOLDERABILITY	32
9.29	PLATING THICKNESS (HERMETIC TYPES ONLY)	32
10	DATA DOCUMENTATION	34
10.1	GENERAL	34
10.1.1	Qualification Approval	34
10.1.2	Testing Level 'B'	34
10.1.2.1	Qualified Components	34
10.1.2.2	Unqualified Components	34
10.1.3	Testing Level 'C'	34
10.1.4	Data Retention/Data Access	35
10.2	COVER SHEET(S)	35
10.3	LIST OF EQUIPMENT USED	35
10.4	LIST OF TEST REFERENCES	35
10.5	SPECIAL IN-PROCESS CONTROL DATA	35
10.6	FINAL PRODUCTION TEST DATA (CHART II)	35
10.7	BURN-IN AND ELECTRICAL MEASUREMENT DATA (CHART III)	35
10.8	QUALIFICATION TEST DATA (CHART IV)	36
10.9	LOT ACCEPTANCE TEST DATA (CHART V)	36
10.9.1	Testing Level 'B'	36
10.9.2	Testing Level 'C'	36
10.10	FAILED COMPONENTS LIST AND FAILURE ANALYSIS REPORT	36
10.11	CERTIFICATE OF CONFORMITY	36
11	DELIVERY	36
12	PACKAGING AND DESPATCH	37

1 INTRODUCTION

1.1 SCOPE

This specification defines the general requirements for the qualification approval, procurement, including lot acceptance testing, and delivery of RF coaxial connectors for space application.

This specification contains the appropriate inspection and test schedules and also specifies the data documentation requirements.

1.2 APPLICABILITY

This specification is primarily applicable to the granting of qualification approval to a component in accordance with ESCC Basic Specification No. [20100](#) and the procurement of such components from qualified manufacturers.

2 APPLICABLE DOCUMENTS

The following documents form part of, and shall be read in conjunction with, this specification. The relevant issues shall be those in effect on the date of placing the purchase order.

2.1 ESCC SPECIFICATIONS

No. [20100](#), Requirements for the Qualification of Standard Electronic Components for Space Application.

No. [20500](#), External Visual Inspection.

No. [20600](#), Preservation, Packaging and Despatch of ESCC Electronic Components.

No. [21300](#), Terms, Definitions, Abbreviations, Symbols and Units.

No. [21700](#), General Requirements for the Marking of ESCC Components.

No. [22800](#), ESCC Non-conformance Control System.

No. [24600](#), Minimum Quality System Requirements.

No. [24800](#), Resistance to Solvents of Marking, Materials and Finishes.

With the exception of ESCC Basic Specifications Nos. [20100](#), [21700](#), [22800](#) and [24600](#), where Manufacturers' specifications are equivalent to, or more stringent than, the ESCC Basic Specifications listed above, they may be used in place of the latter, subject to the approval of the ESCC Executive.

Such replacements shall be clearly identified in the applicable Process Identification Document (PID) and listed in an appendix to the appropriate Detail Specification.

Unless otherwise stated herein, references within the text of this specification to "the Detail Specification" shall mean the relevant ESCC Detail Specification.

2.2 OTHER (REFERENCE) DOCUMENTS

ESA PSS-01-702, A Thermal Vacuum Test for the Screening of Space Materials.

IEC Publication No. 68, Basic Environmental Testing Procedures.

IEC Publication No. 169-1, RF Coaxial Connectors, General Requirements and Measuring Methods.

IEC Publication No. 410, Sampling Plans and Procedures for Inspection by Attributes.

2.3 ORDER OF PRECEDENCE

For the purpose of interpretation and in case of conflict with regard to documentation, the following order of precedence shall apply:

- (a) ESCC Detail Specification.
- (b) ESCC Generic Specification.
- (c) ESCC Basic Specification.
- (d) Other documents, if referenced herein.

3 TERMS, DEFINITIONS, ABBREVIATIONS, SYMBOLS AND UNITS

The terms, definitions, abbreviations, symbols and units specified in ESCC Basic Specification No. 21300 shall apply.

4 REQUIREMENTS

4.1 GENERAL

The test requirements for qualification approval of a component shall comprise final production tests (see Chart II) and qualification testing (see Chart IV).

The test requirements for procurement of components shall comprise final production tests (Chart II) together with, when applicable, a level of lot acceptance testing (see Chart V) to be specified by the Orderer.

If a Manufacturer elects to eliminate a final production test by substituting an in-process control or statistical process control procedure, the Manufacturer is still responsible for delivering components that meet all of the performance, quality and reliability requirements defined in this specification and the Detail Specification.

4.1.1 Specifications

For qualification approval, procurement (including lot acceptance testing) and delivery of components in conformity with this specification, the specifications listed in Section 2 of this document shall apply in total unless otherwise specified herein or in the Detail Specification.

4.1.2 Conditions and Methods of Test

The conditions and methods of test shall be in accordance with this specification, the ESCC Basic Specifications referenced herein and the Detail Specification.

4.1.3 Manufacturer's Responsibility for Performance of Tests and Inspections

The Manufacturer shall be responsible for the performance of tests and inspections required by the applicable specifications. These tests and inspections shall be performed at the plant of the manufacturer of the components unless it is agreed by the ESCC Executive, prior to commencing qualification testing, or procurement, to use an approved external facility.

4.1.4 Inspection Rights

The ESCC Executive (for qualification approval or for a procurement) reserves the right to monitor any of the tests and inspections scheduled in the applicable specifications.

4.1.5 Pre-encapsulation Inspection

Not applicable.

4.2 QUALIFICATION APPROVAL REQUIREMENTS ON A MANUFACTURER

To obtain and maintain the qualification approval of a component, or family of components, a Manufacturer shall satisfy the requirements of ESCC Basic Specification No. [20100](#).

4.3 DELIVERABLE COMPONENTS

Components delivered to this specification shall be processed and inspected in accordance with the relevant Process Identification Document (PID). Each delivered component shall be traceable to its production lot. Components delivered to this specification shall have completed satisfactorily all tests to the testing level and lot acceptance level specified in the purchase order (see Para. 4.3.2).

ESCC qualified components delivered to this specification shall be produced from lots that are capable of passing all tests, and sequences of tests, that are defined in Charts IV and V. The Manufacturer shall not knowingly supply components that cannot meet this requirement. In the event that, subsequent to delivery and prior to operational use, a component is found to be in a condition such that it could not have passed these tests at the time of manufacture, this shall be grounds for rejection of the delivered lot.

4.3.1 Lot Failure

Lot failure may occur during final production tests (Chart II), qualification testing (Chart IV) or lot acceptance testing (Chart V).

Should such failure occur, the non-conformance procedure shall be initiated in accordance with ESCC Basic Specification No. [22800](#).

Should such failure occur during procurement, the manufacturer shall notify the Orderer by telex within 2 working days, giving details of the number and mode of failure and the suspected cause.

In the case where qualification approval has been granted to the component, he shall, at the same time by the same means, inform the ESCC Executive in order that the latter may consider its implications.

No further testing shall be performed on the failed components except on instruction from the Orderer. The Orderer shall inform the Manufacturer and the ESCC Executive within 2 working days of receipt of the telex, by the same means, what action shall be taken.

In the case where lot failure occurs during qualification testing, the Manufacturer shall immediately notify the ESCC Executive who will define a course of action to be followed. No further testing shall be performed on the failed components.

4.3.2 Testing and Lot Acceptance Levels

This specification defines 1 level of testing severity which is designated by the letter 'B' (see Chart I) and 3 levels of lot acceptance testing (see Chart V).

The lot acceptance levels are designated 1, 2 and 3 and are comprised of tests as follows:

Level 3 (LA3): None.

Level 2 (LA2): Electrical and Endurance Subgroup.

Level 1 (LA1): Environmental and Mechanical Subgroup plus Electrical and Endurance Subgroup.

The required lot acceptance level shall be specified in a purchase order.

4.4 MARKING

All components procured and delivered to this specification from a source qualified according to ESCC Basic Specification No. 20100 shall be marked in accordance with ESCC Basic Specification No. 21700. Thus, they shall bear the ESA symbol to signify their conformance to the ESCC qualification approval requirements and full compliance with the requirements of this specification and the Detail Specification.

Components procured from sources which are not ESCC qualified, provided that they fully comply with the procurement requirements of this specification and the Detail Specification may bear the ESCC marking with the exception of the ESA symbol.

4.5 MATERIALS AND FINISHES

All non-metallic materials and finishes, that are not within a hermetically sealed enclosure, of the components specified herein shall meet the outgassing requirements as outlined in ESA PSS-01-702.

Specific requirements for materials and finishes are specified in the Detail Specification.

5 PRODUCTION CONTROL

5.1 GENERAL

The minimum requirements for production control, which are equally applicable to procurement, are defined in ESCC Basic Specification No. 20100, Paras 5.1 and 5.2.

5.2 SPECIAL IN-PROCESS CONTROLS

Before assembly, the different elements of the connectors shall be submitted to the following controls.

5.2.1 Contact Engagement and Separation Forces

A sample of female centre contacts shall be checked for contact engagement and separation forces as defined in Para. 9.3 of this specification. The sample shall be selected in accordance with Level S-4 of IEC Publication No. 410, AQL 1.0.

5.2.2 External Visual Inspection

Before assembly, the different elements of the connectors shall be visually inspected in accordance with ESCC Basic Specification No. 20500.

5.2.3 Gold Plate Porosity

A sample of 10 contacts from each plating lot shall be placed in a clean glass container. A solution of 1 part of concentrated nitric acid (specific gravity: 1.42) and 1 part of distilled water at a temperature of $+25 \pm 5$ °C shall be poured over the contacts. No bubbles shall emanate from the contact surfaces within 15 seconds from application of the solution.

5.2.4 Plating Thickness

The thickness of the outer gold layer and barrier layers shall be measured on 10 male and 10 female contacts, 3 coupling nuts, 3 shells and 3 ferrules, using a non-destructive method or metallographic cross section on the active part as specified in the Detail Specification.

In the event of conflict, the metallographic cross sectioning method shall govern (see the Detail Specification for values).

Hermetic receptacles shall be broken to free the contacts or shall be microsectioned along centre contacts in order to determine the plating thickness.

It is not necessary to verify the thickness of underlayers that are not barrier layers.

5.2.5 Crimping Capability

3 bodies/ferrules shall be assembled and crimped to the cable as specified in the Detail Specification using the Manufacturer's approved crimping tools and cabling procedure.

The sample shall meet the requirements of Para. 9.15(a) and (b) of this specification.

5.2.6 Solderability

3 bodies/ferrules shall be tested in accordance with the requirements of Para. 9.28 of this specification.

5.3 DOCUMENTATION

Documentation of special in-process controls shall be in accordance with the requirements of Para. 10.5 of this specification.

CHART I - TESTING LEVELS

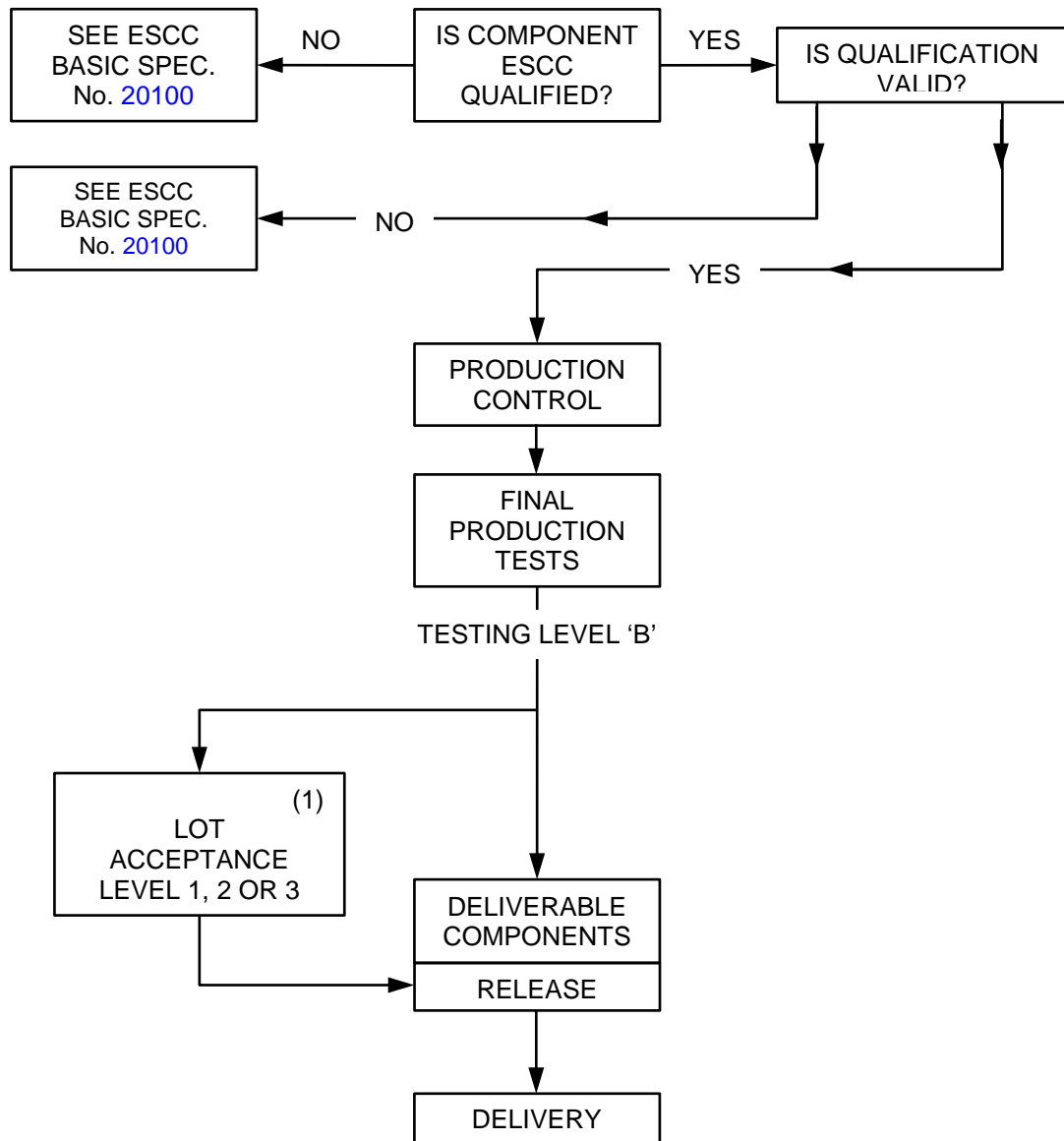

NOTES:

1. When applicable.

6 FINAL PRODUCTION TESTS

6.1 GENERAL

Unless otherwise specified in the Detail Specification, all components used for qualification testing and all components for delivery, including those submitted to Lot Acceptance tests, shall be subjected to tests and inspections in accordance with Chart II.

Unless otherwise specified in the Detail Specification, the tests shall be performed in the order shown.

Any components that do not meet these requirements shall be removed from the lot and at no future time be re-submitted to the requirements of this specification.

6.2 TEST METHODS AND CONDITIONS

The applicable test methods and conditions are specified in the paragraphs referenced in Chart II of this specification.

6.3 FAILURE CRITERIA

6.3.1 Parameter Limit Failure

A component shall be counted as a limit failure if 1 or more parameters exceed the limits shown in Table 2 of the Detail Specification. Any component which exhibits a limit failure prior to the final production test sequence shall be rejected, but not counted when determining lot rejection.

6.3.2 Other Failures

A component shall be counted as a failure in any of the following cases:

- Mechanical failure.
- Handling failure.
- Lost component.

6.4 FAILED COMPONENTS

A component shall be considered as a failed component if it exhibits 1 or more of the failure modes described in Para. 6.3 of this specification.

6.5 LOT FAILURE

In case of lot failure, the Manufacturer shall act in accordance with the requirements specified in Para. 4.3.1 of this specification.

6.5.1 Lot Failure during 100% Testing

If the number of components failed on the basis of the failure criteria described in Para. 6.3 (excluding handling failures and lost components) exceeds 10% of the number of components submitted to final production tests and electrical measurements, the lot shall be considered as failed.

If a lot is composed of groups of components of one family, defined in one ESCC Detail Specification, but separately identifiable for any reason, then the lot failure criteria shall apply separately to each identifiable group.

6.5.2 Lot Failure during Sample Testing

A lot shall be considered as failed if the number of allowable failures during sample testing, selected in accordance with General Inspection Level I of IEC Publication No. 410 and the applicable AQL, as specified in the Detail Specification, is exceeded.

If lot failure occurs in either case, 100% testing may be performed with the lot failure criteria given in Para. 6.5.1.

6.6 DOCUMENTATION

Data documentation of final production test data shall be in accordance with the requirements of Para. 10.6 of this specification.

7 BURN-IN AND ELECTRICAL MEASUREMENTS (CHART III)

Not applicable.

8 QUALIFICATION APPROVAL AND LOT ACCEPTANCE TESTS

8.1 QUALIFICATION TESTING

8.1.1 General

Qualification testing shall be in accordance with the requirements of Chart IV of this specification. The tests to Chart IV shall be performed on the specified sample, chosen at random from components which have successfully passed the tests in Chart II for testing level 'B'. This sample constitutes the qualification test lot.

The qualification test lot is divided into subgroups and all components assigned to a subgroup shall be subjected to all of the tests in that subgroup, in the sequence shown.

Components shall be serialised prior to Chart IV testing.

The applicable test requirements are detailed in the paragraphs referenced in Chart IV.

The conditions governing qualification testing are given in ESCC Basic Specification No. [20100](#), Para. 5.3 and, for the extension or renewal of qualification approval, in Paras 6.3 and 6.4.

8.1.2 Distribution within the Qualification Test Lot

A sample of 32 connector pairs shall be submitted to qualification testing (Chart IV).

Where a Detail Specification covers a range or series of components that are considered similar, then the qualification test lot shall be comprised of component types so selected that they adequately represent all of the various mechanical, structural and electrical peculiarities of the procured range or series.

The selected distribution shall be as specified or agreed with the ESCC Executive.

8.2 LOT ACCEPTANCE TESTING

8.2.1 General

The sample sizes of the 3 lot acceptance levels are specified in Chart V.

All components assigned to a subgroup shall be subjected to all of the tests of that subgroup in the sequence shown.

The tests to Chart V shall be performed on the specified sample which shall have been chosen, whenever possible, at random from the proposed delivery lot. The applicable test requirements are detailed in the paragraphs referenced in Chart V.

As a minimum for procurement of non-qualified components, lot acceptance level 3 tests shall apply. For procurement of qualified components, lot acceptance testing shall be performed if specified in a purchase order. Procurement lots ordered with a lot acceptance test level shall be delivered only after successful completion of lot acceptance testing.

8.2.2 Distribution within the Sample Lot for Lot Acceptance Testing

Where a Detail Specification covers a range or series of components that are considered similar, then it may be necessary that the sample for lot acceptance testing be comprised of component types so selected that they adequately represent all of the various mechanical, structural and electrical peculiarities of the procured range or series.

The distribution of the component types will normally vary from procurement to procurement and shall be specified by the Orderer.

8.2.3 Lot Acceptance Level 3 Testing (LA3)

No tests or inspections are required for this level.

8.2.4 Lot Acceptance Level 2 Testing (LA2)

Lot acceptance level 2 testing shall comprise tests on an electrical and endurance subgroup.

For the electrical and endurance subgroup, the following shall apply:

- (a) Components selected for the electrical and endurance subgroup, shall be serialised prior to the tests.
- (b) The tests in this subgroup are considered to be destructive and therefore components of testing level 'B' so tested shall not form part of the delivery lot.

8.2.5 Lot Acceptance Level 1 Testing (LA1)

Lot acceptance level 1 testing shall comprise the tests for LA2 (electrical and endurance subgroup) plus tests on an environmental and mechanical subgroup. For the electrical and endurance subgroup, the requirements and conditions for LA2 (see Para. 8.2.4) shall apply.

For the environmental and mechanical subgroup, the following shall apply:

- (a) Components selected for the environmental and mechanical subgroup shall be serialised prior to the tests.
- (b) The tests in this subgroup are considered to be destructive and therefore components of testing level 'B' so tested shall not form part of the delivery lot.

8.3 FAILURE CRITERIA

The following criteria shall apply to qualification testing and to lot acceptance testing.

8.3.1 Environmental and Mechanical Test Failures

The following shall be counted as component failures:

- Components which fail during tests for which the pass/fail criteria are inherent in the test method, e.g. soldering proof, etc.

8.3.2 Electrical Failures

The following shall be counted as component failures:

- Components which, when submitted to electrical measurements on completion of environmental tests in accordance with either Table 2 or Table 6, as specified in the Detail Specification, fail 1 or more of the applicable limits.
- Components which, when subjected to electrical measurement at intermediate and end-points during endurance testing, in accordance with Table 6 of the Detail Specification, fail 1 or more of the applicable limits.
- Components which, when subjected to measurement of electrical characteristics, in accordance with Table 2 of the Detail Specification, fail 1 or more of the applicable limits.

8.3.3 Other Failures

The following additional failures may also occur during qualification testing or lot acceptance testing:

- Components failing to comply with the requirements of ESCC Basic Specification No. [20500](#).
- Lost components.

8.4 FAILED COMPONENTS

A component shall be considered as failed if it exhibits 1 or more of the failure modes detailed in Para. 8.3 of this specification. The allowable number of failed components per subgroup, the aggregate failure constraints and the permitted distribution of such failures are shown at the foot of Charts IV and V of this specification.

When requested by the ESCC Executive or the Orderer, failure analysis of failed components shall be performed by the Manufacturer and the results provided.

Failed components from successful lots shall be marked as such and be stored at the Manufacturer's plant for 24 months.

8.5 LOT FAILURE

A lot shall be considered as failed if the allowable number of failures according to Chart IV or V of this specification, as relevant, has been exceeded. In the case of lot failure, the Manufacturer shall act in accordance with Para. 4.3.1 of this specification.

8.6 DOCUMENTATION

For qualification testing, the qualification test data shall be documented in accordance with the requirements of Para. 10.8 of this specification. In the case of lot acceptance testing, the data shall be documented in accordance with the requirements of Para. 10.9 of this specification.

CHART II - FINAL PRODUCTION TESTS

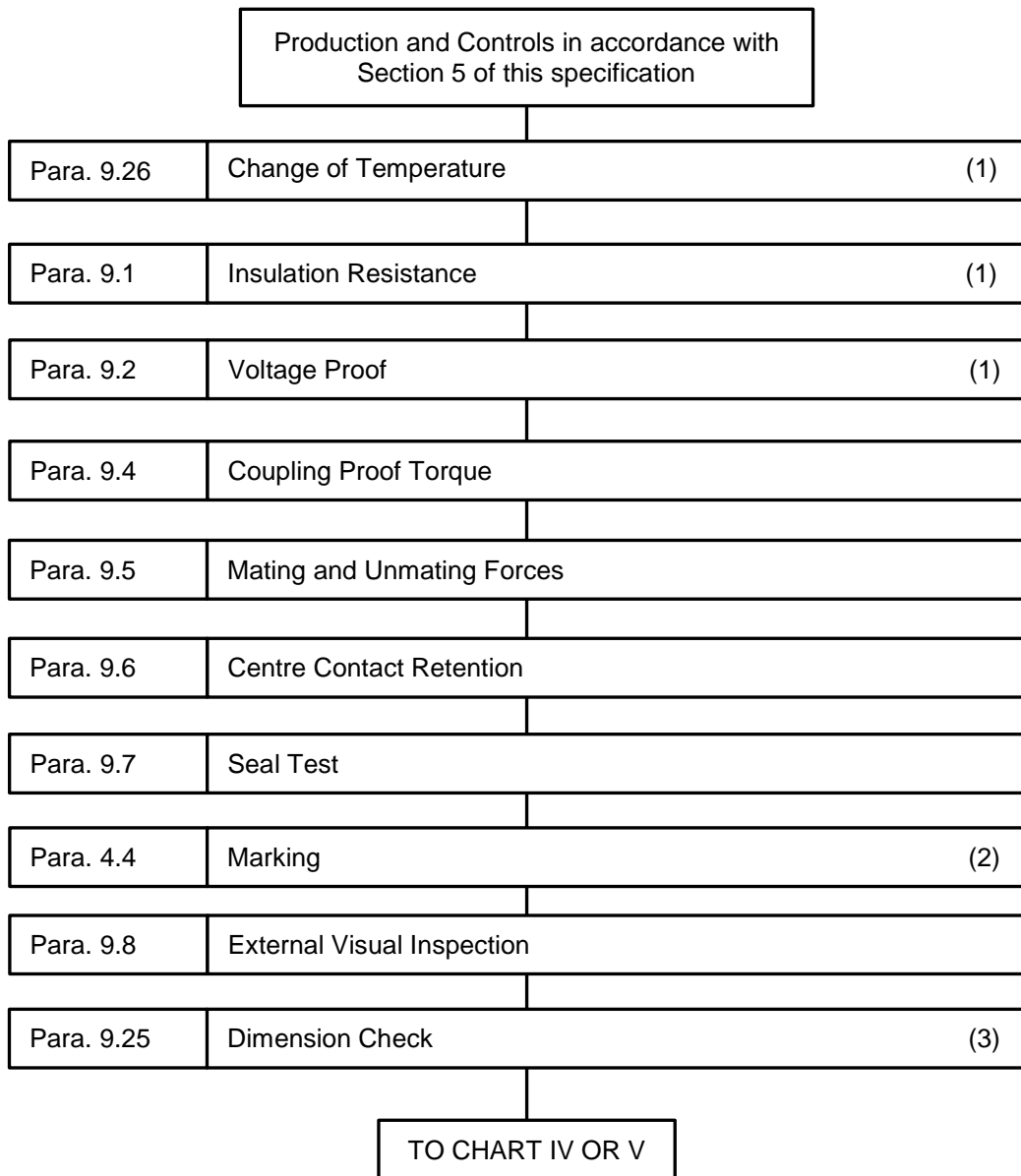

NOTES:

1. Not applicable to Variants where the centre contact and insulator are not mounted in the connector for delivery.
2. Marking may be performed at any point in the sequence.
3. These tests do not have to be repeated if performed as part of the Manufacturer's standard process. The results shall not be counted for PDA.

CHART III IS NOT APPLICABLE

CHART IV - QUALIFICATION TESTS

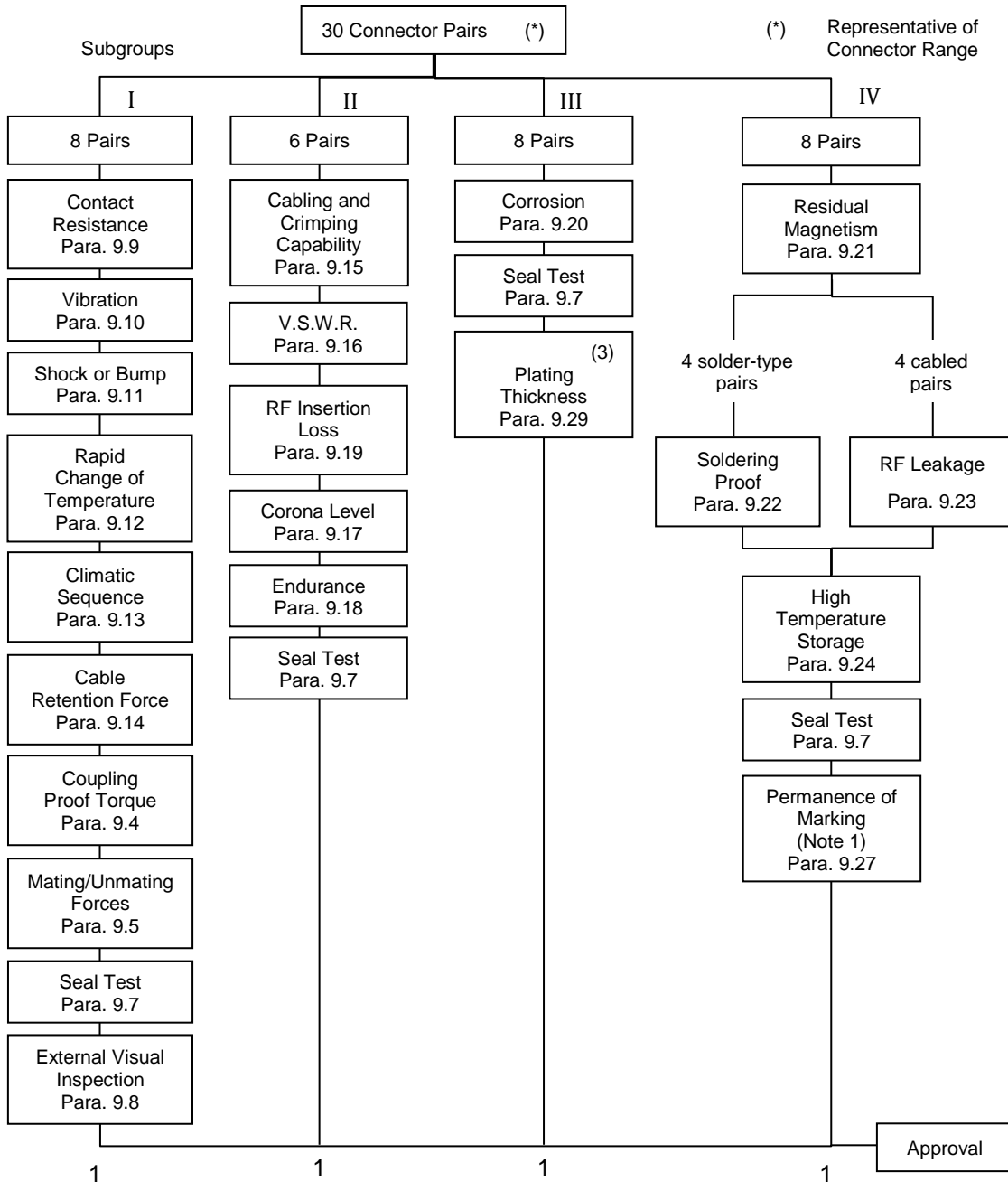

NOTES:

1. Not applicable to engraved parts.
2. Allowable number of failed components: 2.
3. Hermetic types only.

CHART V - LOT ACCEPTANCE TESTS

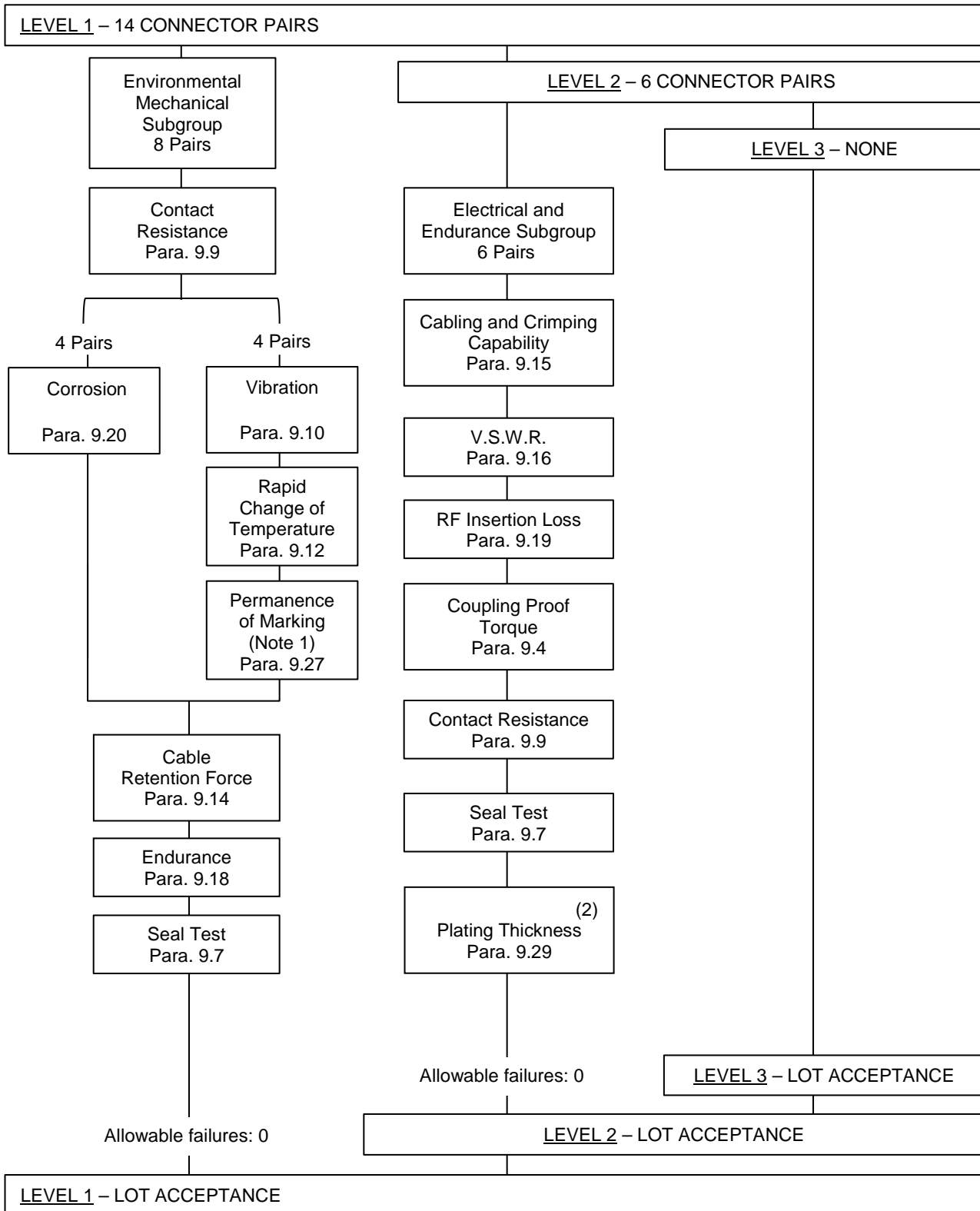

NOTES:

1. Not applicable to engraved parts.
2. Hermetic types only.

9 TEST METHODS AND PROCEDURES

If a Manufacturer elects to eliminate or modify a test method or procedure, the Manufacturer is still responsible for delivering components that meet all of the performance, quality and reliability requirements defined in this specification and the Detail Specification.

Documentation supporting the change shall be approved by the ESCC Executive and retained by the Manufacturer. It shall be copied, when requested, to the ESCC Executive.

The change shall be specified in the Detail Specification and in the PID.

9.1 INSULATION RESISTANCE

The insulation resistance shall be measured on the uncabled connectors between the centre contact and the body under a voltage of 500 Vdc. The measurements shall be read after 1 minute of voltage application.

9.2 VOLTAGE PROOF

The connectors shall be tested under the following conditions:

- (a) The maximum relative humidity shall be 50%.
- (b) Precautions shall be taken to prevent air-gap breakdowns.
- (c) The test voltage specified in Figure 2 of the Detail Specification shall be applied instantaneously.
- (d) The points of application of the test voltage shall be between the centre contact and the shell of the uncabled connectors.
- (e) The duration of application of the test voltage shall be 1 minute.

9.3 CONTACT ENGAGEMENT AND SEPARATION FORCES

The female contacts shall be tested as follows:

A force which is gradually increased shall be applied with force speed not exceeding 1mm/second until the steel test pin properly engages with, or separates from, the female connectors. The polished steel test pins shall be defined in the Detail Specification. The oversize test pin shall be engaged and separated from each female contact 3 times. Then, the engagement force shall be measured with the maximum diameter test pin. Subsequently, the minimum diameter test pin shall be engaged and separated once to measure the withdrawal force. The engagement and separation forces shall meet the requirements of the Detail Specification.

9.4 COUPLING PROOF TORQUE

To be tested to Special Inspection Level S-4, AQL 1.0 of IEC Publication No. 410.

The connector shall be engaged with its mating counterpart (gauge) and the coupling nut tightened to the torque specified in the Detail Specification. After 1 minute, the connector pair shall be disconnected. The coupling mechanism shall not be dislodged and the interface dimensions of the connector shall remain as specified in the Detail Specification.

9.5 MATING AND UNMATING FORCES

To be tested to Special Inspection Level S-4, AQL 1.0 of IEC Publication No. 410.

9.5.1 Bayonet and Screw Coupling

The connector shall be mated with its mating gauge. During the entire mating or unmating cycle (until the connector is fully mated or unmated), the necessary torque shall not exceed the value specified in the Detail Specification.

A screw-coupling connector is fully mated with its mating gauge when their reference planes coincide.

A bayonet-coupling connector is fully mated with its mating gauge when the bayonet studs have passed the detent and their reference planes coincide.

No additional tightening torque shall be applied.

The gauge is a steel jig containing the critical interface dimensions specified in the Detail Specification.

9.5.2 Push-pull Coupling

The connector under test shall be mated with its mating gauge. During this engaging cycle, the force necessary to fully mate the connectors shall not exceed the value specified in the Detail Specification.

Upon completion of mating, an opposite force necessary for unmating shall be applied. This force shall be within the limits specified.

9.5.3 Blind-mate, Slide-on Coupling (Female Connector Only)

The female connector under test shall be mated with its male mating gauge. During this engaging cycle, the force necessary to fully mate the connectors shall not exceed the value specified in the Detail Specification.

Upon completion of mating, an opposite force necessary for unmating shall be applied. This force shall be within the limits specified.

9.6 CENTRE CONTACT RETENTION

Axial and rotational forces as specified in the Detail Specification shall be applied, first in one direction and then in the other, to the centre contact of an assembled and uncabled connector, using an appropriate method. The inner contact shall be inspected after the forces have been applied in one direction and again after the forces have been applied in the opposite direction to determine if the contact has been displaced from the specified interface dimensions.

9.7 SEAL TEST

9.7.1 Hermetically Sealed Connectors

The leakage rate shall not exceed 10^{-8} cubic centimetres per second of helium under a vacuum of 10^{-5} Torr.

9.7.2 Leakage (Barrier-sealed Connectors)

Connectors shall be subjected to an air pressure of 2.1 kg/cm² applied to one end, and the whole assembly immersed in water or isopropyl alcohol at a temperature of +15 to +25 °C.

The connectors shall remain immersed for 2 minutes maximum and there shall be no bubbles emanating from the other end.

9.7.3 Leakage (Panel-sealed Connectors)

Panel-sealed specimens shall be mounted in a normal manner in a suitable test jig. The mating end of the connectors shall be sealed with the appropriate mating connector and the whole assembly immersed in water or isopropyl alcohol at a temperature of +15 to + 25 °C.

An air pressure of 2.1 kg/cm² shall be applied to one end of the assembly for 2 minutes maximum, and there shall be no bubbles emanating from the connectors.

9.8 EXTERNAL VISUAL INSPECTION

External visual inspection shall be performed in accordance with ESCC Basic Specification No. [20500](#).

9.9 CONTACT RESISTANCE

9.9.1 Method A - Using Separate Power Supplies and Meters

The measurement shall be performed in accordance with Figure I(a). The contact resistances to be measured are:

- (a) The contact resistance of the mated inner conductor contacts.
- (b) The contact resistance of the mated outer conductor contacts (if possible, the coupling nut shall be removed for this measurement).
- (c) For cabled connectors, the contact resistance between the cable braid or outer conductor and the connector at the point of contact.

The test current, voltage and contact resistance limits shall be as specified in Table 6 of the Detail Specification.

9.9.2 Method B - Using Integrated Power Supplies and Meters with a 4 Terminal Bridge Arrangement

9.9.2.1 *Equipment*

The milliohm meter shall have the following characteristics:

- Maximum Potential across Sample: 20mV.
- Maximum Measuring Frequency: 2kHz.
- Minimum Accuracy: ±2% of requirement.
- Maximum Applied Current: 50mA rms.

9.9.2.2 *Centre Contacts*

- (a) Connect the Kelvin Clips to the inner conductors of the mated pair of connectors as shown in Figure I(b).
- (b) Record the value of contact resistance.
- (c) Reverse the connections.
- (d) Record the value of contact resistance.
- (e) Calculate the average value of the 2 measurements from (b) and (d) above.

The average value of the contact resistance shall not exceed the limits specified in Table 6 of the Detail Specification.

9.9.2.3 Outer Contacts

Repeat the procedure of 9.9.2.2 above, but connect the Kelvin Clips to the 2 outer conductors close to the interface plane as shown in Figure I(b).

FIGURE I(a) - CONTACT RESISTANCE MEASUREMENT - METHOD A

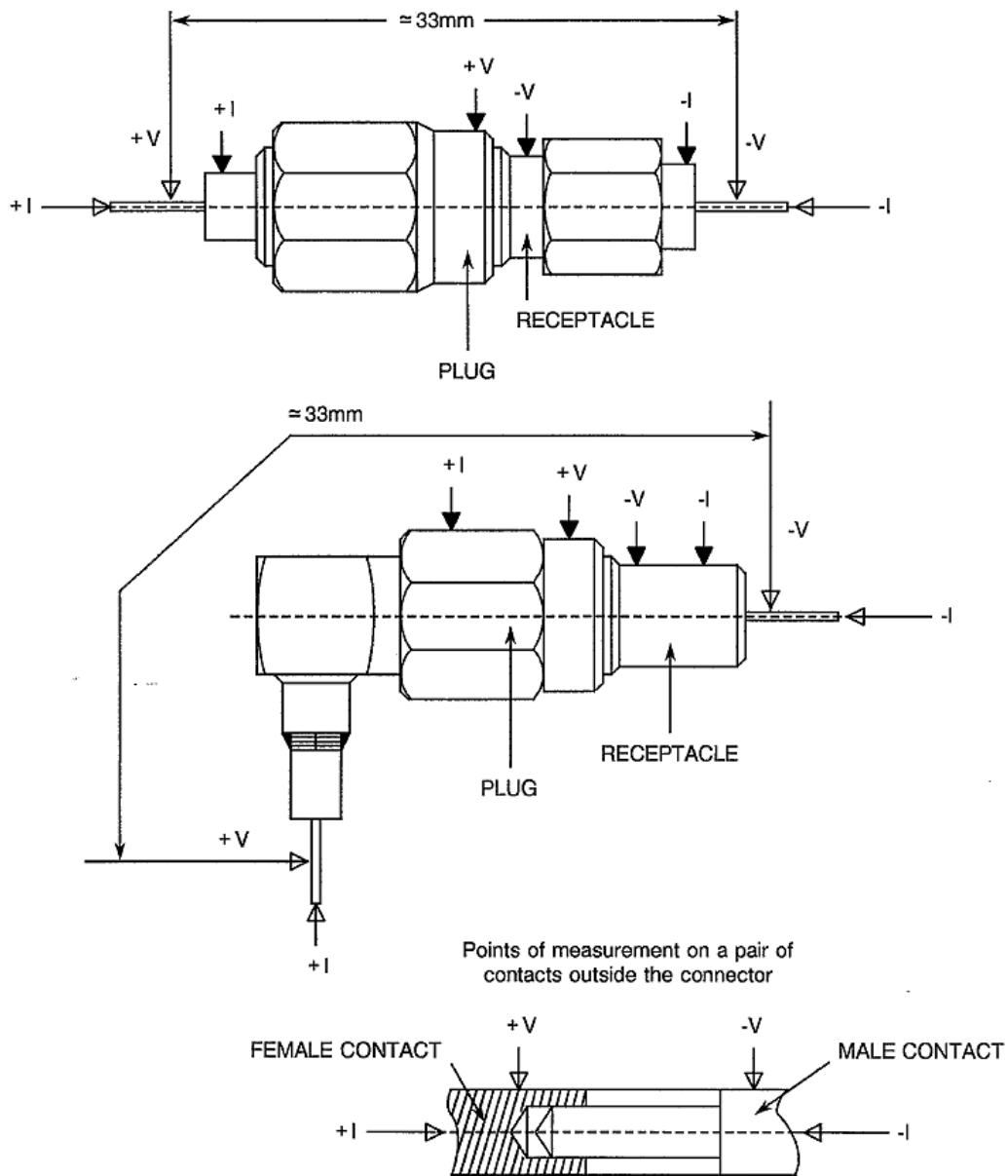

NOTES:

1. Points of measurement on a mated pair of connectors:
 - The white arrows show probe positions for measuring contact resistance of the centre contact.
 - The black arrows show probe positions for measuring contact resistance of the outer contact.

FIGURE I(b) - CONTACT RESISTANCE MEASUREMENT - METHOD B

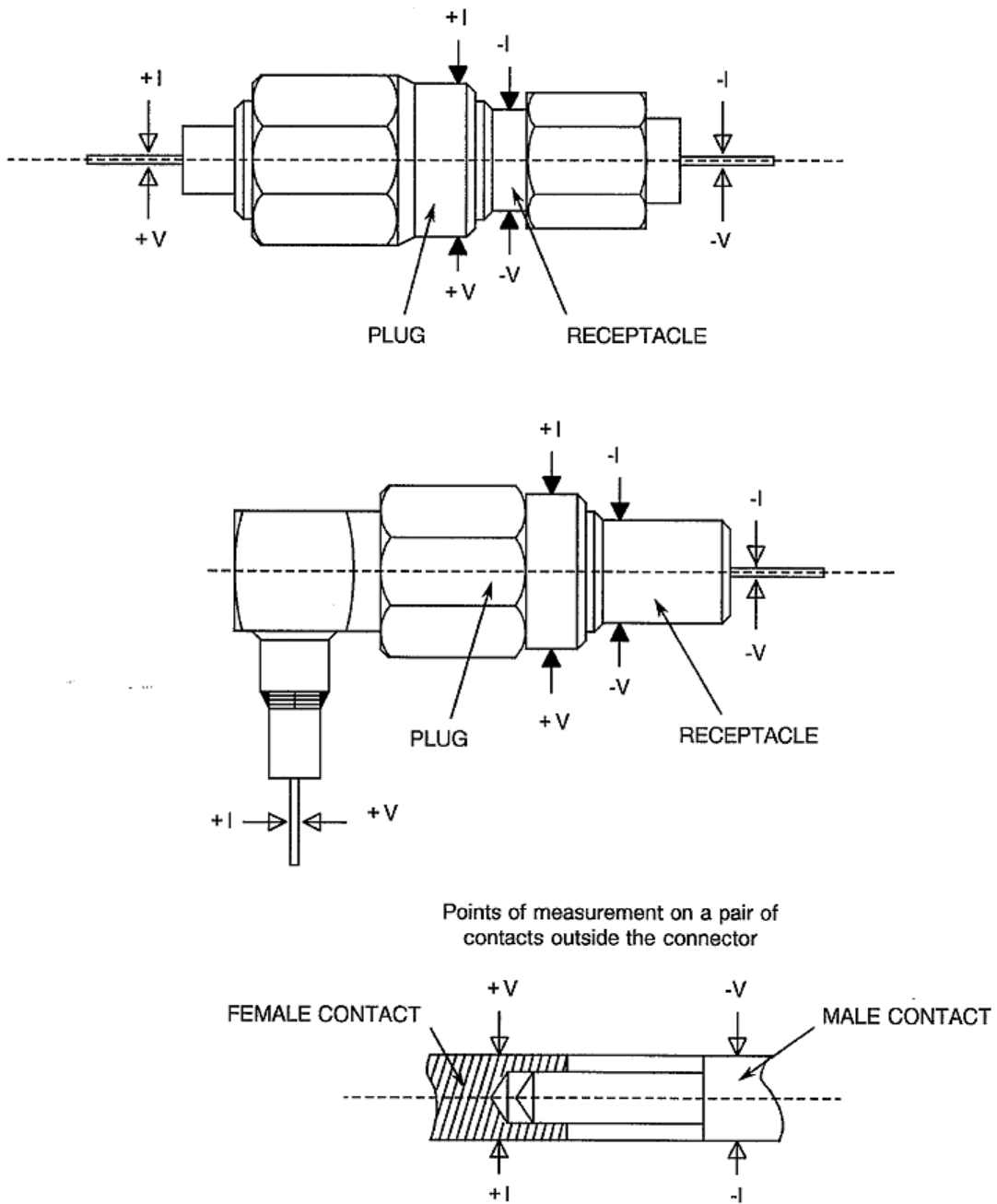

NOTES:

- Points of measurement on a mated pair of connectors:
 - The white arrows show probe positions for measuring contact resistance of the centre contact.
 - The black arrows show probe positions for measuring contact resistance of the outer contact.

9.10 VIBRATION

9.10.1 Mounting

The mated specimens shall be mechanically connected to the vibration generator either directly or by means of a fixture as specified below. Mounting fixtures shall be such that they enable the specimen to be vibrated in 3 mutually perpendicular axes in turn, which should be so chosen that faults are most likely to be revealed.

If the component is provided with specific means of mounting, they shall be used as specified in the Detail Specification and any additional restraining straps should be avoided.

Unless otherwise specified, components not provided with specific mounting means shall be clamped by the body.

If external connections, necessary for measuring and supply purposes, are specified in the Detail Specification, they should add the minimum restraint and mass.

9.10.2 Procedure

The components shall be subjected to Test 'Fc' of IEC Publication No. 68-2-6, Procedure B4. Sweep frequency: 10-2000-10 Hz. The entire frequency range of 10 to 2000Hz and return to 10Hz shall be traversed in 10 minutes.

This cycle shall be performed 12 times in each of the 3 directions (i.e. 36 times in total), so that the motion is applied for a total period of approximately 6 hours. The vibration shall be 1.5mm (total display) or 30g, whichever is smaller.

9.10.3 Measurement during Vibration

During the last cycle in each direction, an electrical measurement shall be made to determine intermittent contact of 10ms or longer duration, or open or short circuiting. At least 100mA shall be flowing through each set of contacts. Contacts may be connected in series.

9.10.4 Final Measurements

After vibration, the components shall be visually examined, mating shall be fully maintained and there shall be no evidence of damage.

Measurements as specified in Table 6 of the Detail Specification shall be performed and shall not exceed the specified limits.

9.11 SHOCK OR BUMP

9.11.1 Shock

9.11.1.1 Mounting

The mated specimens shall be fixed to the shock machine, either directly or by means of a fixture as specified below. Mounting fixtures shall enable the specimens to be subjected to shocks in 3 mutually perpendicular axes in turn. When the component is provided with specific mounting means, these shall be used as specified in the Detail Specification and any additional restraining straps should be avoided.

Unless otherwise specified, components not provided with specific mounting means shall be clamped by the body. When external connections, necessary for measuring and supply purposes, are specified in the Detail Specification, they should add the minimum restraint and mass.

9.11.1.2 Procedure

The components shall be subjected to Test 'Ea' of IEC Publication No. 68-2-27. Unless otherwise specified in the Detail Specification, the following conditions shall apply:

- Shape of shock pulse: Sawtooth.
- Peak acceleration: 100g.
- Duration of pulse : 6ms
- Number of shocks: 18 (3 shocks in each direction in the 3 perpendicular axes of the test specimen).

9.11.1.3 Visual Examination

After shock, the components shall be visually examined, mating shall be fully maintained and there shall be no evidence of damage.

Measurements as specified in Table 6 of the Detail Specification shall be performed and shall not exceed the specified limits.

9.11.2 Bump

9.11.2.1 Mounting

As specified in Para. 9.11.1.1, the word "shock" to be replaced by "bump".

9.11.2.2 Procedure

The components shall be subjected to Test 'Eb' of IEC Publication No. 68-2-29. Unless otherwise specified in the Detail Specification, the following conditions shall apply:

- Peak acceleration: 390m/s².
- Number of bumps: 4000 ±10.

9.11.2.3 Visual Examination

After bump, the components shall be visually examined, mating shall be fully maintained and there shall be no evidence of damage.

Measurements as specified in Table 6 of the Detail Specification shall be performed and shall not exceed the specified limits.

9.12 RAPID CHANGE OF TEMPERATURE

9.12.1 Initial Measurements

None.

9.12.2 Procedure

The components shall be subjected to Test 'Na' of IEC Publication No. 68-2-14 with 30 minutes at each temperature extreme as specified in the Detail Specification (Figure 2(b) - Variants).

9.12.3 Recovery and Final Measurements

The duration of recovery shall be 24 ±2 hours at room temperature conditions. After recovery, the components shall be visually examined and there shall be no evidence of damage. Measurements as specified in Table 6 of the Detail Specification shall be performed and shall not exceed the specified limits.

9.13 CLIMATIC SEQUENCE

Mated connector pairs shall be submitted to the following.

9.13.1 Initial Measurements

No initial measurements are required.

9.13.2 Dry Heat

Not applicable.

9.13.3 Damp Heat, Accelerated, First Cycle

Unless otherwise specified in the Detail Specification, the components shall be subject to Test 'Db', Variant 02 of IEC Publication No. 68-2-30 for 1 cycle of 24 hours. After recovery, the components shall be subject immediately to the cold test.

9.13.4 Cold Test

The components shall be subject to Test 'Ab' of IEC Publication No. 68-2-1. Duration: 2 hours. Minimum storage temperature as prescribed in the Detail Specification (Figure 2(b) - Variants).

9.13.5 Low Air Pressure

The components shall be subject to Test 'M' of IEC Publication No. 68-2-13 under the following conditions:

- 5 minutes at 44 mBar.
- Temperature: +15 to +35 °C.

Proof voltage as per Table 6 of the Detail Specification shall be applied for 5 minutes immediately after the pressure of 44mbar has been attained. There shall be no evidence of flash-over or breakdown.

9.13.6 Damp Heat, Accelerated, Remaining Cycles

The components shall be subjected to Test 'Db', Variant 2 of IEC Publication No. 68-2-30 for 5 cycles of 24 hours.

9.13.7 Final Measurements

After a recovery period of 1 to 24 hours, the components shall be visually inspected according to ESCC Basic Specification No. [20500](#) and there shall be no evidence of mechanical damage. Measurements as specified in Table 6 of the Detail Specification shall be performed and shall not exceed the specified limits.

9.14 CABLE RETENTION FORCE

- (a) The connector shall be assembled to its test cable as specified in the Detail Specification. It shall be firmly fixed and a movable sleeve attached to the cable. The sleeve shall then be moved away from the fixed connector longitudinally and gradually, and in such a manner that the cable remains unbent and untwisted. A scale for measuring the retention force (see the Detail Specification) shall be attached to the sleeve. The force shall be maintained for 30 seconds minimum.
- (b) The assembly, still under tension, shall be tested for continuity, using a simple low voltage lamp circuit, and shall then be examined for mechanical failure, loosening or rupture.
- (c) With the connector still in the fixed position, the cable shall be held at a point 50 times the diameter of the cable from the connector and a torque shall be applied in both directions as specified in the Detail Specification.
- (d) This test is only applicable to connectors designed to accept flexible cables. The cable shall then be bent at a radius of 10 times the diameter of the cable, starting at the connector, at an angle of $90 \pm 5^\circ$ from the axis of the connector, then reversed $180 \pm 10^\circ$.

This procedure shall be repeated 4 times prior to re-test and re-examination as specified in point (b) above.

9.15 CABLING AND CRIMPING CAPABILITY (CABLE CONNECTORS ONLY)

The connector shall be assembled and crimped or soldered to the cable as specified in the Detail Specification, using the Manufacturer's approved crimping tools and cabling procedure.

6 cables shall be assembled. In cases where both male and female connectors are required for Qualification/LAT testing, there shall be 3 cable assemblies with male connectors at each end and 3 cable assemblies with female connectors at each end. These 6 cable assemblies shall have identical lengths.

Once assembled, the cable assemblies shall be subjected to the following examinations and measurements, as applicable:

- Crimps shall be examined under X10 magnification and shall be free from cracks.
- Solder joints shall be examined under X10 magnification. They shall be bright and show a good wetting.
- Interface and external dimensions shall conform to those shown in Figure 2 of the Detail Specification.
- Insulation resistance and voltage proof shall meet the requirements of the Detail Specification.

9.16 VOLTAGE STANDING WAVE RATIO (VSWR) OR REFLECTION COEFFICIENT

The VSWR or reflection coefficient shall be measured in accordance with a suitable test method using an appropriate test set-up and measuring equipment. The rear part of flange-mounted connectors may be machined off to allow direct assembly of a coaxial test set-up to the rear part of the connector.

The measured values shall not exceed those given in the Detail Specification.

9.17 CORONA LEVEL

The corona level shall be determined in accordance with Para. 14.11 of IEC Publication No. 169-1 and the values shall not exceed those specified in the Detail Specification. The test frequency shall be 40 to 60 Hz.

9.18 ENDURANCE

Each connector under test shall be mated with a typical production mating connector as per this specification. The connector shall be submitted to the number of cycles of mating and unmating specified in the Detail Specification. The connector and its mating part shall be completely mated at the specified torque and completely unmated during this cycle. The threads of rotational parts shall not be lubricated for this test unless specified in the Detail Specification. It is permitted to shake or blow debris from the threads or interface surfaces at intervals of not less than 50 cycles. Solvents and tools shall not be used for cleaning.

After this test, the mating and unmating forces, centre and shell contact resistances shall be measured and shall meet the requirements of Table 6 of the Detail Specification. The connectors shall be visually examined and, except for contact and thread wear, shall show no evidence of physical damage.

9.19 RF INSERTION LOSS

The RF Insertion Loss shall be measured in accordance with a suitable test method using an appropriate test set-up and measuring equipment. If not already done for the previous measurements, the rear part of flange-mounted connectors may be machined off to allow direct assembly of a coaxial test set-up to the rear part of the connector.

The measured values shall not exceed those given in the Detail Specification.

9.20 CORROSION

Unmated and uncabled connectors shall be submitted to Test 'Ka' of IEC Publication No. 68-2-11 for 48 hours.

After the test, the connectors shall be inspected and expose no base metal on the interface or mating surface. They shall meet the requirements of Table 6 of the Detail Specification.

9.21 RESIDUAL MAGNETISM

After having been submitted to a magnetic field of 200 Gauss, the unwired connectors shall be placed 3mm from the meter probe tip and oriented for a maximum reading. The measurement unit shall be gamma (1 gamma = 10^{-5} Gauss) and the value shall be as specified in the Detail Specification.

9.22 SOLDERING PROOF (SOLDER-TYPE CONNECTORS ONLY)

The connectors shall be wired and soldered, using the approved Manufacturer's procedures. The connectors shall then be inspected and shall meet the requirements of Table 6 of the Detail Specification.

9.23 RF LEAKAGE (SEMI-RIGID CABLE CONNECTORS ONLY)

9.23.1 For RF Leakage \geq -100dB

The mating connector pair to be tested shall be assembled as shown in Figure II(a) and tested as shown in Figure II(b). The close-fitting brass tubing shall be machined to thread into the connector instead of the compression nut. This test, set up between 500MHz and 11GHz, shall have a dynamic range from -20dB to better than .100dBm or a difference of 90dB.

Using a +20dBm RF source with 10dB isolation, an additional 30dB range can be obtained by use of attenuator pads or a step attenuator producing a total range of 120dB.

The shorting plunger is adjusted to produce a maximum reading in the detector with the tri-axial assembly inserted. The insertion loss caused by the insertion of the tri-axial assembly adjusted as shown is a measure of the total leakage of the mated connector pair both at its interface and the clamping points to both cables.

9.23.2 For RF Leakage $<$ -100dB (susceptibility)

The mated connector pair shall be tested as shown in Figure II(c).

9.24 HIGH TEMPERATURE STORAGE

Mated connectors shall be submitted to a high temperature storage test in accordance with Test 'Bb' of IEC Publication No. 68-2-2 for 1000 hours.

Test Temperature: maximum operating temperature.

After the test, the connectors shall remain at room ambient temperature for 1 hour minimum and 2 hours maximum and shall meet the requirements of Table 6 of the Detail Specification.

A slight uniform discolouration of the parts is allowed.

9.25 DIMENSION CHECK

In accordance with ESCC Basic Specification No. [20500](#) and the Detail Specification, on 3 connectors or accessories, and in accordance with the table below for contacts.

If a failure occurs, the complete lot shall be checked.

Lot Size	Sampling
2 to 15	2
16 to 25	3
26 to 90	5
91 to 150	8
151 to 280	13
281 to 500	20
501 to 1200	32
1201 to 3200	50
3201 to 10000	80

9.26 CHANGE OF TEMPERATURE

The components shall be subjected to Test 'Nb' of IEC Publication No. 68-2-14. The number of cycles shall be 5 with 30 minutes at -20 and + 70 °C respectively.

9.27 PERMANENCE OF MARKING

In accordance with ESCC Basic Specification No. 24800.

9.28 SOLDERABILITY

The Solderability Test 'Ta' of IEC Publication No. 68-2-20 shall be performed on parts to be soldered as applicable (Method 2, Size B).

9.29 PLATING THICKNESS (HERMETIC TYPES ONLY)

The test shall be performed as specified in Para. 5.2.4 of this specification.

FIGURE II(a) - CONNECTOR ASSEMBLY FOR RF LEAKAGE TEST

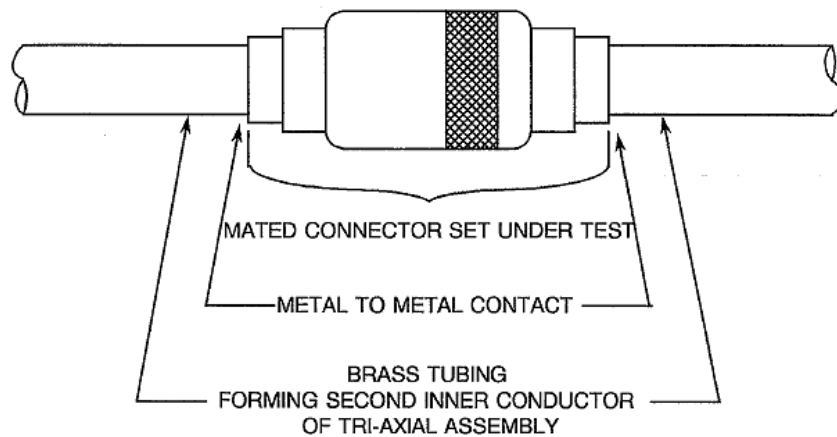

FIGURE II(b) - RF LEAKAGE TEST SET-UP

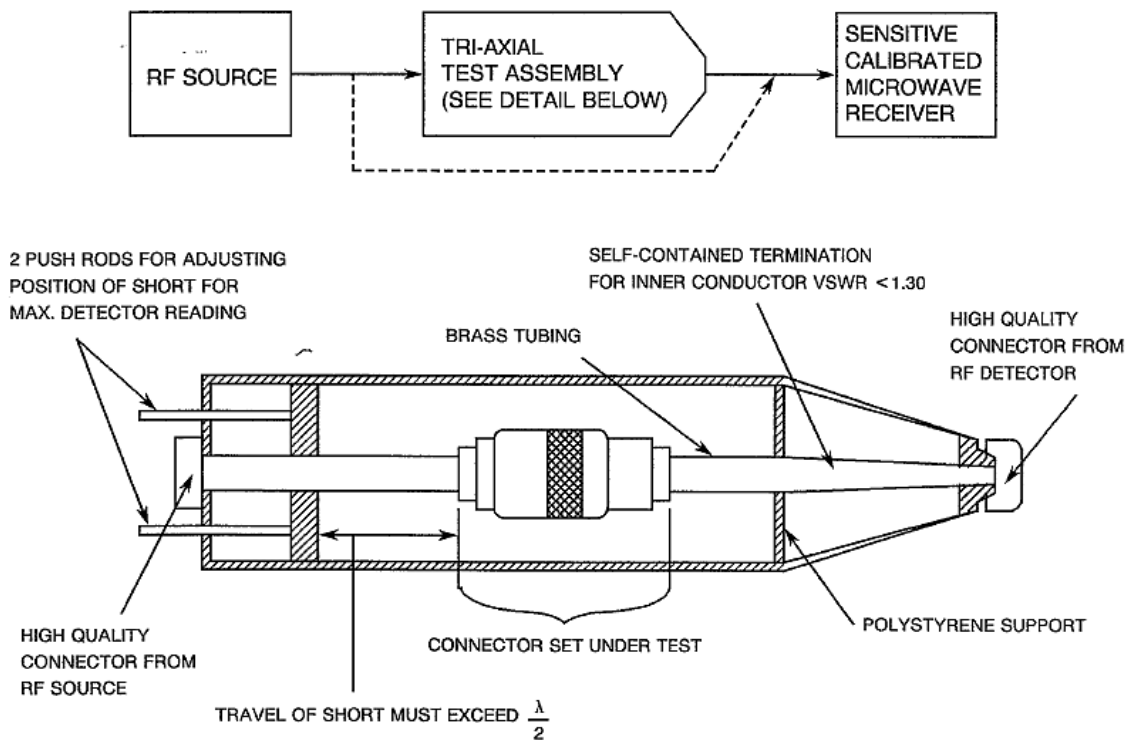
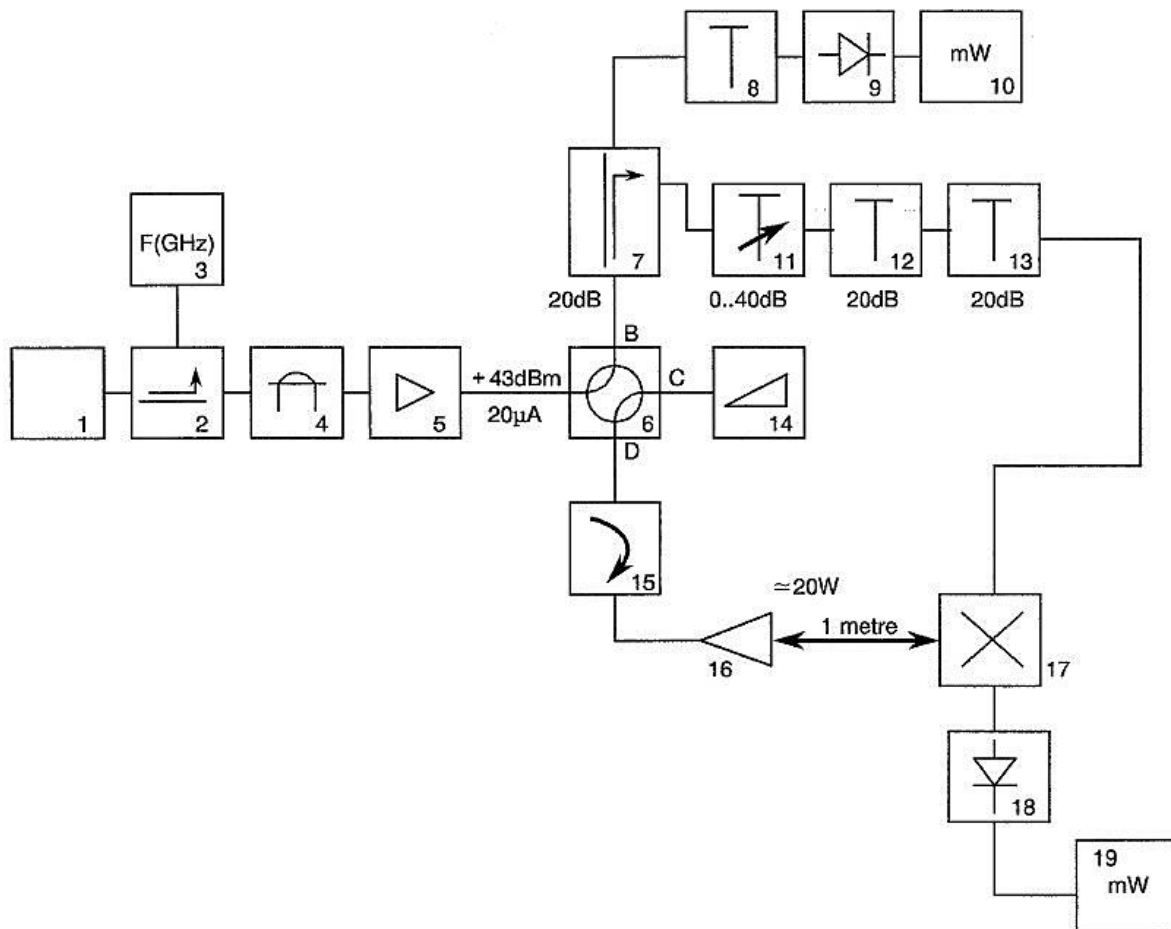

FIGURE II(c) - TEST SET UP FOR SUSCEPTIBILITY MEASUREMENT



LIST OF EQUIPMENT (FOR INFORMATION ONLY):

1. RF sweep oscillator.
2. Coupler 10dB.
3. Counter.
4. Band pass filter 8.2 - 12.4 GHz.
5. TWT 20W.
6. Waveguide switch.
7. Waveguide coupler 20dB.
8. Attenuators 10dB (high power) +20dB (3).
9. Power sensor.
10. Microwatt meter.
11. Variable attenuator 40dB.
12. Attenuator 30dB.
13. Attenuator 20dB.
14. Waveguide absorber.
15. Waveguide isolator.
16. Antenna.
17. DUT.
18. Power Sensor.
19. Microwatt meter.

10 DATA DOCUMENTATION

10.1 GENERAL

For the qualification approval records and with each component delivery, a data documentation package is required. Depending on the testing level and lot acceptance level specified for the component, this package shall be compiled from:

- (a) Cover sheet (or sheets).
- (b) List of equipment (testing and measuring).
- (c) List of test references.
- (d) Special in-process control test data.
- (e) Final production test data (Chart II) (but see Para. 10.6).
- (f) Qualification test data (Chart IV).
- (g) Lot acceptance test data (Chart V) (when applicable).
- (h) Failed component list and failure analysis report (see Para. 8.4).
- (i) Certificate of Conformity.

Items (a) to (i) inclusive shall be grouped, preferably as subpackages and, for identification purposes, each page shall include the following information:

- ESCC Component number.
- Manufacturer's name.
- Lot identification.
- Date of establishment of the document.
- Page number.

10.1.1 Qualification Approval

In the case of qualification approval, the items listed in Para. 10.1 (a) to (i) less item (g) are required.

10.1.2 Testing Level 'B'

10.1.2.1 *Qualified Components*

For deliveries of qualified components, the following documentation shall be supplied:

- (a) Cover sheet (if all of the information is not included on the Certificate of Conformity).
- (b) Certificate of Conformity.
- (c) Attributes record of measurements, tests and inspections performed in Chart II (including PDA figure) and Chart V (where applicable).
- (d) Failed components list.

10.1.2.2 *Unqualified Components*

For deliveries of unqualified components, the documentation to be supplied shall be in accordance with Para. 10.1.2.1 plus the following:

- (a) Special in-process control data (where applicable).
- (b) Failure analysis report on failed components.

10.1.3 Testing Level 'C'

Not applicable.

10.1.4 Data Retention/Data Access

If not delivered, all data shall be retained by the Manufacturer for a minimum of 5 years during which time it shall be available to the ESCC Executive and the Orderer, if requested, for review. The Manufacturer shall deliver variables Data/Reports to the Orderer if required by the Purchase Order.

10.2 COVER SHEET(S)

The cover sheet(s) of the data documentation package shall include as a minimum:

- (a) Reference to the Detail Specification, including issue and date.
- (b) Reference to the applicable ESCC Generic Specification, including issue and date.
- (c) Component type and number.
- (d) Lot identification.
- (e) Number of purchase order.
- (f) Information relative to any additions to this specification and/or the Detail Specification.
- (g) Manufacturer's name and address.
- (h) Location of the manufacturing plant.
- (i) Signature on behalf of Manufacturer.
- (j) Total number of pages of the data package.

10.3 LIST OF EQUIPMENT USED

A list of equipment used for tests and measurements shall be prepared, if not in accordance with the data given in the Process Identification Document (PID). Where applicable, this list shall contain inventory number, Manufacturer's type number, serial number, etc. This list shall indicate for which tests such equipment was used.

10.4 LIST OF TEST REFERENCES

This list shall include all Manufacturer's references or codes which are necessary to correlate the test data provided with the applicable tests specified in the tables of the Detail Specification.

10.5 SPECIAL IN-PROCESS CONTROL DATA

The minimum and maximum values for the plating thickness measurements shall be provided.

10.6 FINAL PRODUCTION TEST DATA (CHART II)

A test result summary shall be compiled showing the total number of components submitted to, and the total number rejected after, each test, measurement and inspection of Chart II.

The final production test data shall form an integral part of the data documentation package, but it is not a mandatory requirement that it be delivered with the qualification lot or delivery lot. However, the data package to be delivered shall contain the information as detailed in Para. 10.1.2 or at least shall contain a list of final production tests actually performed and a certification that the data is available for review.

10.7 BURN-IN AND ELECTRICAL MEASUREMENT DATA (CHART III)

Not applicable.

10.8 QUALIFICATION TEST DATA (CHART IV)

All data shall be referenced to the relevant serial numbers. Detailed records shall be provided of the components submitted to each test in each of the subgroups and of those rejected.

Detailed data shall be provided of all electrical measurements made in accordance with Table 6 of the Detail Specification, as and where applicable.

10.9 LOT ACCEPTANCE TEST DATA (CHART V)**10.9.1** Testing Level 'B'

All data shall be referenced to the relevant serial numbers. Detailed records shall be provided of the components submitted to each test in each of the subgroups (as relevant to the lot acceptance level) and of those rejected.

Detailed data shall be provided of all electrical measurements made in accordance with Table 6 of the Detail Specification, as and where applicable.

10.9.2 Testing Level 'C'

Not applicable.

10.10 FAILED COMPONENTS LIST AND FAILURE ANALYSIS REPORT

The failed component list and failure analysis report shall provide full details of:

- (a) The reference number and description of the test or measurement performed as defined in this specification and/or the Detail Specification.
- (b) The serial number (if applicable) of the failed component.
- (c) The failed parameter and the failure mode of the component.
- (d) Detailed failure analysis, if requested.

10.11 CERTIFICATE OF CONFORMITY

A Certificate of Conformity shall be established as defined in ESCC Basic Specification No. [20100](#).

11 DELIVERY

For qualification approval, the disposition of the qualification test lot and its related documentation shall be as specified in ESCC Basic Specification No. [20100](#) and the relevant paragraphs of Section 10 of this specification.

For procurement, for each order, the items forming the delivery are:

- (a) The delivery lot.
- (b) The components used for lot acceptance testing, (when applicable), but not forming part of the delivery lot (see Para's 8.2.4 and 8.2.5).
- (c) The relevant documentation in accordance with the requirements of Section 10 of this specification.

In the case of a component for which a valid qualification approval is in force, all data of all components submitted to LA1 and LA2 testing shall also be copied, when requested, to the ESCC Executive.

12 **PACKAGING AND DESPATCH**

The packaging and despatch of components to this specification shall be in accordance with the requirements of ESCC Basic Specification No. [20600](#).