



## **ATTENUATORS AND LOADS, RF, COAXIAL, FIXED**

### **ESCC Generic Specification No. 3403**

Issue 6	July 2018
---------	-----------



### **LEGAL DISCLAIMER AND COPYRIGHT**

European Space Agency, Copyright © 2018. All rights reserved.

The European Space Agency disclaims any liability or responsibility, to any person or entity, with respect to any loss or damage caused, or alleged to be caused, directly or indirectly by the use and application of this ESCC publication.

This publication, without the prior permission of the European Space Agency and provided that it is not used for a commercial purpose, may be:

- copied in whole, in any medium, without alteration or modification.
- copied in part, in any medium, provided that the ESCC document identification, comprising the ESCC symbol, document number and document issue, is removed.

**DOCUMENTATION CHANGE NOTICE**

(Refer to <https://escies.org> for ESCC DCR content)

DCR No.	CHANGE DESCRIPTION
<a href="#">1027, 1145</a>	Specification upissued to incorporate editorial and technical changes per DCR.

**TABLE OF CONTENTS**

1	INTRODUCTION	8
1.1	SCOPE	8
1.2	APPLICABILITY	8
2	APPLICABLE DOCUMENTS	8
2.1	ESCC SPECIFICATIONS	8
2.2	OTHER (REFERENCE) DOCUMENTS	9
2.3	ORDER OF PRECEDENCE	9
3	TERMS, DEFINITIONS, ABBREVIATIONS, SYMBOLS AND UNITS	9
4	REQUIREMENTS	9
4.1	GENERAL	9
4.1.1	Specifications	10
4.1.2	Conditions and Methods of Test	10
4.1.3	Manufacturer's Responsibility for Performance of Tests and Inspections	10
4.1.4	Inspection Rights	10
4.1.5	Customer Source Inspection	10
4.1.5.1	Pre-Encapsulation Customer Source Inspection	10
4.1.5.2	Final Customer Source Inspection	10
4.2	QUALIFICATION AND QUALIFICATION MAINTENANCE REQUIREMENTS ON A MANUFACTURER	10
4.3	DELIVERABLE COMPONENTS	11
4.3.1	ESCC Qualified Components	11
4.3.2	ESCC Components	11
4.3.3	Lot Failure	11
4.4	MARKING	11
4.5	MATERIALS AND FINISHES	12
5	PRODUCTION CONTROL	12
5.1	GENERAL	12
5.2	SPECIAL IN-PROCESS CONTROLS	12
5.2.1	Contact Engagement and Separation Forces	12
5.2.2	Gold Plate Porosity	12
5.2.3	Plating Thickness	12
5.2.4	Pre-Encapsulation Inspection	13
5.2.5	Dimension Check	13
5.2.6	Weight	13
5.2.7	Documentation	13
6	SCREENING TESTS	13

6.1	GENERAL	13
6.2	FAILURE CRITERIA	13
6.2.1	Environmental and Mechanical Test Failure	13
6.2.2	Parameter Drift Failure	13
6.2.3	Parameter Limit Failure	13
6.2.4	Other Failures	14
6.3	FAILED COMPONENTS	14
6.4	LOT FAILURE	14
6.4.1	Lot Failure during 100% Testing	14
6.4.2	Lot Failure during Sample Testing	14
6.5	DOCUMENTATION	14
7	QUALIFICATION, QUALIFICATION MAINTENANCE AND LOT VALIDATION TESTING	14
7.1	QUALIFICATION TESTING	15
7.1.1	General	15
7.1.2	Distribution within the Qualification Test Lot	15
7.2	QUALIFICATION WITHIN A TECHNOLOGY FLOW	15
7.3	QUALIFICATION MAINTENANCE (PERIODIC TESTING)	15
7.4	LOT VALIDATION TESTING	15
7.5	FAILURE CRITERIA	16
7.5.1	Environmental and Mechanical Test Failures	16
7.5.2	Electrical Failures	16
7.5.3	Other Failures	16
7.6	FAILED COMPONENTS	16
7.7	LOT FAILURE	16
7.8	QUALIFICATION, PERIODIC TESTING AND LOT VALIDATION TESTING SAMPLES	16
7.9	DOCUMENTATION	17
8	TEST METHODS AND PROCEDURES	17
8.1	CONTACT ENGAGEMENT AND SEPARATION FORCES	17
8.2	GOLD PLATE POROSITY	17
8.3	PRE-ENCAPSULATION INSPECTION	17
8.4	THERMAL CYCLING	17
8.5	RANDOM VIBRATION	18
8.5.1	Random Vibration during Screening	18
8.5.2	Random Vibration during Qualification, Periodic Testing and Lot Validation Testing	19
8.6	ELECTRICAL MEASUREMENTS	20
8.6.1	General	20

8.6.1.1	Voltage Standing Wave Ratio (VSWR) (Attenuators and Loads)	20
8.6.1.2	Attenuation (Attenuators Only)	21
8.6.1.3	Resistance (Loads Only)	21
8.6.2	Parameter Drift Values	21
8.6.3	High and Low Temperatures Electrical Measurements	21
8.6.4	Room Temperature Electrical Measurements	22
8.6.5	Intermediate and End-Point Electrical Measurements	22
8.7	BURN-IN	22
8.8	EXTERNAL VISUAL INSPECTION AND DIMENSION CHECK	22
8.9	MECHANICAL SHOCK	22
8.10	RAPID CHANGE OF TEMPERATURE	23
8.11	GLITCHES (INSERTION LOSS STABILITY OVER TEMPERATURE) (ATTENUATORS ONLY)	24
8.12	CLIMATIC SEQUENCE	24
8.12.1	Dry Heat	24
8.12.2	Damp Heat, Accelerated, First Cycle	24
8.12.3	Cold	24
8.12.4	Low Air Pressure	25
8.12.5	Damp Heat, Accelerated, Remaining Cycles	25
8.12.6	Final Inspection and Electrical Measurements (Data Points)	25
8.13	COUPLING PROOF TORQUE	25
8.14	MATING AND UNMATING FORCES	25
8.14.1	Bayonet and Screw Coupling	25
8.14.2	Push-Pull Coupling	26
8.15	RADIOGRAPHIC INSPECTION	26
8.16	CONNECTOR REPEATABILITY (ATTENUATORS ONLY)	26
8.17	OPERATING LIFE	26
8.18	PERMANENCE OF MARKING	27
8.19	RESIDUAL MAGNETISM (GOLD-PLATED WITH COPPER UNDERPLATE VERSION ONLY)	27
8.20	RF LEAKAGE	27
8.21	PEAK POWER	27
9	DATA DOCUMENTATION	28
9.1	GENERAL	28
9.1.1	Qualification and Qualification Maintenance	28
9.1.2	Component Procurement and Delivery	28
9.1.3	Additional Documentation	28
9.1.4	Data Retention/Data Access	28

9.2	COVER SHEET(S)	29
9.3	LIST OF EQUIPMENT USED	29
9.4	LIST OF TEST REFERENCES	29
9.5	SPECIAL IN-PROCESS CONTROLS DATA (CHART F2)	29
9.6	SCREENING TESTS DATA (CHART F3)	29
9.7	QUALIFICATION, PERIODIC TESTING AND LOT VALIDATION TESTING DATA (CHART F4)	29
9.7.1	Qualification Testing	29
9.7.2	Periodic Testing for Qualification Maintenance	30
9.7.3	Lot Validation Testing	30
9.8	FAILED COMPONENTS LIST AND FAILURE ANALYSIS REPORT	30
9.9	CERTIFICATE OF CONFORMITY	30
10	DELIVERY	30
11	PACKAGING AND DESPATCH	31
12	CHARTS	32
12.1	CHART F1 - GENERAL FLOW FOR PROCUREMENT	32
12.2	CHART F2 - PRODUCTION CONTROL	33
12.3	CHART F3 - SCREENING TESTS	34
12.4	CHART F4 – QUALIFICATION, PERIODIC TESTING AND LOT VALIDATION TESTING	35

## 1 INTRODUCTION

### 1.1 SCOPE

This specification defines the general requirements for the qualification, qualification maintenance, procurement, and delivery of fixed RF coaxial attenuators and loads for space applications. This specification contains the appropriate inspection and test schedules and also specifies the data documentation requirements.

### 1.2 APPLICABILITY

This specification is primarily applicable to the granting of qualification approval to components qualified in accordance with one of the following ESCC methods:

- Qualification of Standard Components per ESCC Basic Specification No. [20100](#).
- Technology Flow Qualification per ESCC Basic Specification No. [25400](#). It is also primarily applicable to the procurement of components so qualified.

This specification may also be applied to the procurement of unqualified components, recommendations for which are given in ESCC Basic Specification No. [23100](#).

## 2 APPLICABLE DOCUMENTS

The following documents form part of, and shall be read in conjunction with, this specification. The relevant issues shall be those in effect on the date of starting qualification or placing the Purchase Order.

### 2.1 ESCC SPECIFICATIONS

- No. [20100](#), Requirements for the Qualification of Standard Electronic Components for Space Application.
- No. [20500](#), External Visual Inspection.
- No. [20600](#), Preservation, Packaging and Despatch of ESCC Components.
- No. [21300](#), Terms, Definitions, Abbreviations, Symbols and Units.
- No. [21700](#), General Requirements for the Marking of ESCC Components.
- No. [22600](#), Requirements for the Evaluation of Standard Electronic Components for Space Application.
- No. [22800](#), ESCC Non-Conformance Control System.
- No. [23100](#), Recommendations on the use of the ESCC Specification System for the Evaluation and Procurement of Unqualified Components.
- No. [24600](#), Minimum Quality System Requirements.
- No. [24800](#), Resistance to Solvents of Marking, Materials and Finishes.
- No. [25400](#), Requirements for the Technology Flow Qualification of Electronic Components for Space Application.
- No. [3402](#), Connectors, RF Coaxial.

For qualification and qualification maintenance or procurement of qualified components, with the exception of ESCC Basic Specifications Nos. [20100](#), [21700](#), [22800](#), [24600](#) and [25400](#), where Manufacturers' specifications are equivalent to, or more stringent than, the ESCC Basic Specifications listed above, they may be used in place of the latter, subject to the approval of the ESCC Executive.



Such replacements shall be clearly identified in the applicable Process Identification Document (PID).

For procurement of unqualified components, where Manufacturers' specifications are equivalent to or more stringent than the applicable ESCC Basic Specifications listed above, they may be used in place of the latter subject to the approval of the Orderer.

Such replacements may be listed in an appendix to the appropriate Detail Specification at the request of the Manufacturer or Orderer, subject to the approval of the ESCC Executive.

Unless otherwise stated herein, references within the text of this specification to "the Detail Specification" shall mean the relevant ESCC Detail Specification.

## 2.2 OTHER (REFERENCE) DOCUMENTS

- IEC Publication No. 60068 Part 2, Basic Environmental Testing Procedures.
- IEC Publication No. 61726, Cable Assemblies, Cables, Connectors and Passive Microwave Components - Screening Attenuation Measurement by the Reverberation Chamber Method.

## 2.3 ORDER OF PRECEDENCE

For the purpose of interpretation and in case of conflict with regard to documentation, the following order of precedence shall apply:

- (a) ESCC Detail Specification.
- (b) ESCC Generic Specification.
- (c) ESCC Basic Specification.
- (d) Other documents, if referenced herein.

## 3 TERMS, DEFINITIONS, ABBREVIATIONS, SYMBOLS AND UNITS

The terms, definitions, abbreviations, symbols and units specified in ESCC Basic Specification No. [21300](#) shall apply.

## 4 REQUIREMENTS

### 4.1 GENERAL

The requirements for the qualification of a component shall be in accordance with ESCC Basic Specification No. [20100](#).

The requirements for Technology Flow Qualification and listing of qualified component types shall be in accordance with ESCC Basic Specification No. [25400](#).

The test requirements for procurement of both qualified and unqualified components (see Chart F1) shall comprise:

- Special In-Process Controls.
- Screening Tests.
- Periodic Testing (for qualified components only).
- Lot Validation Testing if stipulated in the Purchase Order.

#### 4.1.1 Specifications

For qualification, qualification maintenance, procurement and delivery of components in conformity with this specification, the applicable specifications listed in Section 2 of this document shall apply in total unless otherwise specified herein or in the Detail Specification.

#### 4.1.2 Conditions and Methods of Test

The conditions and methods of test shall be in accordance with this specification, the ESCC Basic Specifications referenced herein and the Detail Specification.

#### 4.1.3 Manufacturer's Responsibility for Performance of Tests and Inspections

The Manufacturer shall be responsible for the performance of tests and inspections required by the applicable specifications. These tests and inspections shall be performed at the plant of the Manufacturer of the components unless it is agreed by the ESCC Executive (for qualification, qualification maintenance, or procurement of qualified components) or the Orderer (for procurement of unqualified components), to use an approved external facility.

#### 4.1.4 Inspection Rights

The ESCC Executive (for qualification, qualification maintenance, or procurement of qualified components) or the Orderer (for procurement of unqualified components, if stipulated in the Purchase Order) reserves the right to monitor any of the tests and inspections scheduled in the applicable specifications.

#### 4.1.5 Customer Source Inspection

##### 4.1.5.1 *Pre-Encapsulation Customer Source Inspection*

If stipulated in the Purchase Order, the Orderer may perform a source inspection at the Manufacturer's facility prior to assembly (including, for example, performance of Pre-Encapsulation Inspection, review of Special In-Process Controls data). Details of the inspections to be performed or witnessed and the required period of notification shall be as stipulated in the Purchase Order.

##### 4.1.5.2 *Final Customer Source Inspection*

If stipulated in the Purchase Order, the Orderer may perform a source inspection at the Manufacturer's facility at the end of Screening or during Lot Validation Testing, if applicable, (including, for example, witness of final Room Temperature Electrical Measurements, performance of External Visual Inspection and Dimension Check, review of the data documentation package). Details of the inspections to be performed or witnessed and the required period of notification shall be as stipulated in the Purchase Order.

#### 4.2 QUALIFICATION AND QUALIFICATION MAINTENANCE REQUIREMENTS ON A MANUFACTURER

To obtain and maintain the qualification of a component, or family of components, a Manufacturer shall satisfy the requirements of ESCC Basic Specification No. [20100](#).

To obtain and maintain the qualification of a component produced using a qualified Technology Flow, a Manufacturer shall satisfy the requirements of ESCC Basic Specification No. [25400](#).

#### 4.3 DELIVERABLE COMPONENTS

##### 4.3.1 ESCC Qualified Components

Components delivered to this specification shall be processed and inspected in accordance with the relevant Process Identification Document (PID).

##### 4.3.2 ESCC Components

Each component, irrespective of qualification status, identified with an ESCC component number and delivered to this specification shall:

- be traceable to its production lot.
- have satisfactorily completed all the tests required by the relevant issues of the applicable specifications.
- be produced from lots that are considered by the Manufacturer to be capable of passing all applicable tests, and sequences of tests, that are defined in Chart F4. The Manufacturer shall not knowingly supply components that cannot meet this requirement. In the event that, subsequent to delivery and prior to operational use, a component is found to be in a condition such that, demonstrably, it could not have passed these tests at the time of manufacture, this shall be grounds for rejection of the delivered lot.

##### 4.3.3 Lot Failure

Lot failure may occur during Screening Tests (Chart F3) or Qualification, Periodic Testing and Lot Validation Testing (Chart F4).

Should such failure occur during qualification, qualification maintenance or procurement of qualified components the Manufacturer shall initiate the non-conformance procedure in accordance with ESCC Basic Specification No. [22800](#). The Manufacturer shall notify the Orderer and the ESCC Executive by any appropriate written means, within 5 working days, giving details of the number and mode of failure and the suspected cause. No further testing or analysis shall be performed on the failed components until so instructed by the ESCC Executive.

Should such failure occur during procurement of unqualified components the Manufacturer shall notify the Orderer by any appropriate written means within 5 working days, giving details of the number and mode of failure and the suspected cause. No further testing or analysis shall be performed on the failed components until so instructed by the orderer. The Orderer shall inform the Manufacturer within 5 working days of receipt of notification what action shall be taken.

#### 4.4 MARKING

All components procured and delivered to this specification shall be marked in accordance with ESCC Basic Specification No. [21700](#).

#### 4.5 MATERIALS AND FINISHES

Specific requirements for materials and finishes are specified in the Detail Specification. Where a definite material or finish is not specified a material or finish shall be used so as to ensure that the component meets the performance requirements of this specification and the Detail Specification. Acceptance or approval of any constituent material or finish does not guarantee acceptance of the finished product.

All materials and finishes of the components specified in the Detail Specification shall comply with the restrictions on materials specified in ESCC Basic Specification No. [22600](#).

### 5 PRODUCTION CONTROL

#### 5.1 GENERAL

Unless otherwise specified herein or in the Detail Specification, all lots of components used for qualification and qualification maintenance, Lot Validation Testing and for delivery shall be subject to tests and inspections in accordance with Chart F2 in the sequence shown.

Any components which do not meet these requirements shall be removed from the lot and at no future time be resubmitted to the requirements of this specification.

The applicable test requirements are detailed in the paragraphs referenced in Chart F2. For qualified components the full production control provisions are defined in the PID.

#### 5.2 SPECIAL IN-PROCESS CONTROLS

##### 5.2.1 Contact Engagement and Separation Forces

A sample of 13 female centre contacts shall be tested for Contact Engagement and Separation Forces as defined in Para. 8.1. If any failure occurs the lot of contacts shall be rejected.

##### 5.2.2 Gold Plate Porosity

A sample of 10 contacts from each plating lot shall be tested for Gold Plate Porosity as defined in Para. 8.2. If any failure occurs the plating lot shall be rejected.

##### 5.2.3 Plating Thickness

If specified in the Detail Specification, plating thickness shall be measured using a non-destructive method or metallographic cross section on samples as follows, as applicable, on the active part as specified in the Detail Specification.

In the event of conflict, the metallographic cross sectioning method shall govern (see Detail Specification for values).

- Male Contacts: 10
- Female Contacts: 10
- Coupling Nuts: 3
- Shells/Accessories: 3

#### 5.2.4 Pre-Encapsulation Inspection

Pre-Encapsulation Inspection shall consist of internal and external visual inspection of all the different elements of the components in accordance with Para. 8.3.

#### 5.2.5 Dimension Check

Dimension Check shall be performed in accordance with Para. 8.8 on 3 samples only. In the event of any failure a 100% Dimension Check shall be performed.

#### 5.2.6 Weight

The maximum weight of the component specified in the Detail Specification shall be guaranteed but not tested.

#### 5.2.7 Documentation

Documentation of Special In-Process Controls shall be in accordance with Para. 9.5.

### 6 SCREENING TESTS

#### 6.1 GENERAL

Unless otherwise specified herein or in the detail specification, all lots of components used for qualification and qualification maintenance, Lot Validation Testing, and for delivery, shall be subjected to tests and inspections in accordance with Chart F3 in the sequence shown. All components shall be serialised prior to the tests and inspections.

Any components which do not meet these requirements shall be removed from the lot and at no future time be resubmitted to the requirements of this specification.

The applicable test methods and conditions are specified in the paragraphs referenced in Chart F3.

#### 6.2 FAILURE CRITERIA

##### 6.2.1 Environmental and Mechanical Test Failure

The following shall be counted as component failures:

Components which fail during tests for which the pass/fail criteria are inherent in the test method, i.e. Vibration Cycling, Contact Engagement and Separation Forces and External Visual Inspection.

##### 6.2.2 Parameter Drift Failure

The acceptable change limits are shown in Parameter Drift Values in the Detail Specification. A component shall be counted as a parameter drift failure if the changes during Burn-in are larger than the drift values ( $\Delta$ ) specified.

##### 6.2.3 Parameter Limit Failure

A component shall be counted as a limit failure if one or more parameters exceed the limits shown in Room Temperature Electrical Measurements or High and Low Temperatures Electrical Measurements in the Detail Specification.

Any component which exhibits a limit failure prior to the submission to Burn-in shall be rejected and not counted when determining lot rejection.

#### 6.2.4 Other Failures

A component shall be counted as a failure in any of the following cases:

- Visual failure.
- Mechanical failure.
- Handling failure.
- Lost component.

Any failure prior to the submission to Burn-in shall be rejected and not counted when determining lot rejection.

#### 6.3 FAILED COMPONENTS

A component shall be considered as a failed component if it exhibits one or more of the failure modes described in Para. 6.2.

#### 6.4 LOT FAILURE

In the case of lot failure, the Manufacturer shall act in accordance with Para. 4.3.3.

##### 6.4.1 Lot Failure during 100% Testing

If the number of components failed on the basis of the failure criteria described in Para. 6.2 subsequent to Burn-in equals or exceeds:

- 6% (rounded upwards to the nearest whole number) of a lot larger than 50 components
- 3 devices of a lot of between 20 and 50 components
- 2 devices of a lot smaller than 20 components

the lot shall be considered as failed.

If a lot is composed of groups of components of one family defined in one ESCC Detail Specification, but separately identifiable for any reason, then the lot failure criteria shall apply separately to each identifiable group.

##### 6.4.2 Lot Failure during Sample Testing

A lot shall be considered as failed if the number of allowable failures during sample testing, as specified herein or in the Detail Specification, is exceeded.

Unless otherwise specified, if a lot failure occurs, a 100% testing may be performed but the cumulative percent defective shall not exceed that specified in Para. 6.4.1.

#### 6.5 DOCUMENTATION

Documentation of Screening Tests shall be in accordance with Para. 9.6.

### 7 QUALIFICATION, QUALIFICATION MAINTENANCE AND LOT VALIDATION TESTING

The requirements of this paragraph are applicable to the tests performed on components or test structures as part of qualification or qualification maintenance in accordance with either ESCC Basic Specification No. 20100 or 25400 as applicable. They are also applicable to Lot Validation Testing as part of the procurement of qualified or unqualified components.

## 7.1 QUALIFICATION TESTING

### 7.1.1 General

Qualification testing shall be in accordance with the requirements specified in Chart F4. The tests of Chart F4 shall be performed on the specified sample chosen at random from components which have successfully passed the tests in Chart F3. This sample constitutes the Qualification Test Lot.

The Qualification Test Lot is divided into subgroups of tests and all components assigned to a subgroup shall be subjected to all of the tests in that subgroup, in the sequence shown. The applicable test requirements are detailed in the paragraphs referenced in Chart F4.

The conditions governing qualification testing are specified in ESCC Basic Specification No. [20100](#).

### 7.1.2 Distribution within the Qualification Test Lot

Where a Detail Specification covers a range or series of components that are considered similar, then the Qualification Test Lot shall be comprised of component types so selected that they adequately represent all of the various mechanical, structural and electrical peculiarities of that range or series.

The distribution shall be as specified by, or agreed with, the ESCC Executive.

## 7.2 QUALIFICATION WITHIN A TECHNOLOGY FLOW

The qualification of a component produced using a qualified Technology Flow shall be in accordance with ESCC Basic Specification No. [25400](#).

## 7.3 QUALIFICATION MAINTENANCE (PERIODIC TESTING)

Qualification is maintained through periodic testing and the test requirements of Para. 7.1 shall apply. For each subgroup the sample size and the period between successive subgroup testing shall be as specified in Chart F4. The conditions governing qualification maintenance are specified in ESCC Basic Specification No. [20100](#).

Qualification of a component, produced using a qualified Technology Flow, is maintained by maintenance of the Technology Flow Qualification itself in accordance with ESCC Basic Specification No. [25400](#).

## 7.4 LOT VALIDATION TESTING

For procurement of qualified components Lot Validation Testing is not required and shall only be performed if specifically stipulated in the Purchase Order.

For procurement of unqualified components the need for Lot Validation Testing shall be determined by the Orderer (ref. ESCC Basic Specification No. [23100](#)).

When Lot Validation Testing is required it shall consist of the performance of one or more of the tests or subgroup test sequences of Chart F4. The testing to be performed and the sample size shall be as stipulated in the Purchase Order.

When procurement of more than one component type is involved from a family, range or series, the selection of representative samples shall also be stipulated in the Purchase Order.

## 7.5 FAILURE CRITERIA

The following criteria shall apply to qualification, qualification maintenance and Lot Validation Testing.

### 7.5.1 Environmental and Mechanical Test Failures

The following shall be counted as component failures:

Components which fail during tests for which the pass/fail criteria are inherent in the test method, e.g. Coupling Proof Torque.

### 7.5.2 Electrical Failures

The following shall be counted as component failures:

Components which fail one or more of the applicable limits at each of the relevant data points specified for environmental, mechanical and endurance testing in Intermediate and End-Point Electrical Measurements in the Detail Specification.

### 7.5.3 Other Failures

A component shall be counted as a failure in any of the following cases:

- Visual failure.
- Mechanical failure.
- Handling failure.
- Lost component.

## 7.6 FAILED COMPONENTS

A component shall be considered as failed if it exhibits one or more of the failure modes detailed in Para. 7.5.

When requested by the ESCC Executive (for qualification, qualification maintenance or procurement of qualified components) or the Orderer (for procurement of qualified or unqualified components), failure analysis of failed components shall be performed under the responsibility of the Manufacturer and the results provided.

Failed components shall be retained at the Manufacturer's plant until the final disposition has been agreed and certified.

## 7.7 LOT FAILURE

For qualification and qualification maintenance, the lot shall be considered as failed if one component in any subgroup of Chart F4 is a failed component based on the criteria specified in Para. 7.5.

For procurement, the lot shall be considered as failed if one component in any test specified for Lot Validation Testing is a failed component based on the criteria specified in Para. 7.5.

In the case of lot failure, the Manufacturer shall act in accordance with Para. 4.3.3.

## 7.8 QUALIFICATION, PERIODIC TESTING AND LOT VALIDATION TESTING SAMPLES

All tests of Chart F4 are considered to be destructive and therefore components so tested shall not form part of the delivery lot.



### 7.9 DOCUMENTATION

Documentation of qualification, periodic testing and Lot Validation Testing shall be in accordance with Para. 9.7.

## 8 TEST METHODS AND PROCEDURES

If a Manufacturer elects to eliminate or modify a test method or procedure, the Manufacturer is still responsible for delivering components that meet all of the performance, quality and reliability requirements defined in this specification and the Detail Specification.

For a qualified component, documentation supporting the change shall be approved by the ESCC Executive and retained by the Manufacturer. It shall be copied, when requested, to the ESCC Executive. The change shall be specified in an appendix to the Detail Specification and in the PID.

For an unqualified component the change shall be approved by the Orderer. The change may be specified in an appendix to the Detail Specification at the request of the Manufacturer or Orderer, subject to the approval of the ESCC Executive.

### 8.1 CONTACT ENGAGEMENT AND SEPARATION FORCES

The female contacts shall be tested as follows:

A force which is gradually increased shall be applied with force speed not exceeding 1mm/second until the steel test pin properly engages with, or separates from, the female connectors. The polished steel test pins shall be as specified in the Detail Specification. The oversize test pin shall be engaged and separated from each female contact 3 times and then the Engagement Force shall be measured with the maximum diameter test pin. Subsequently, the minimum diameter test pin shall be engaged and separated once to measure the Separation Force. The engagement and separation forces shall meet the limits specified in the Detail Specification.

### 8.2 GOLD PLATE POROSITY

The contacts shall be placed in a clean glass container. A solution of 1 part of concentrated nitric acid (specific gravity: 1.42) and 1 part distilled water at a temperature of  $+25 \pm 5$  °C shall be poured over the contacts. No bubbles shall emanate from the contact surfaces within 15 seconds from application of the solution.

### 8.3 PRE-ENCAPSULATION INSPECTION

Prior to assembly, the different elements of the components shall be inspected in accordance with the requirements of ESCC Basic Specification No. [20500](#).

### 8.4 THERMAL CYCLING

The components shall be subjected to thermal cycling as follows:

The number of cycles shall be 5 with 15 minutes at each storage temperature extreme given in the Detail Specification. The rate of change of temperature shall be between 2 °C/minute and 5 °C/minute. Saver connectors shall be connected to the connectors under test during the thermal cycling.

8.5 RANDOM VIBRATION

8.5.1 Random Vibration during Screening

Prior to the commencement of testing the components shall be mounted onto a suitable test jig or apparatus, such as that shown in the diagram below.

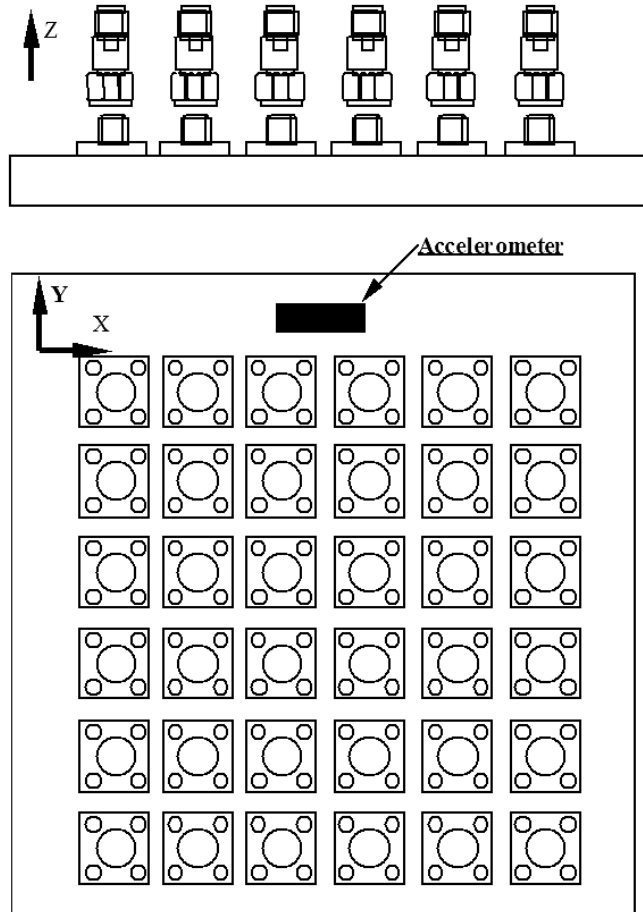

The random vibration testing shall be performed in accordance with the conditions defined below.

- Random Vibration Test Curve:

Envelope: Grms = 33	
Frequency Range	Level
20 to 100 Hz	+6db/Octave
100 to 1000 Hz	0.67g <sup>2</sup> /Hz
1000 to 2000 Hz	-3db/Octave

- Duration: 60s in each of the 3 mutually perpendicular axes defined in the above diagram.

8.5.2 Random Vibration during Qualification, Periodic Testing and Lot Validation Testing

Prior to the commencement of testing the components shall be mounted onto a suitable test jig or apparatus, such as that shown in the diagrams below.

ATTENUATORS

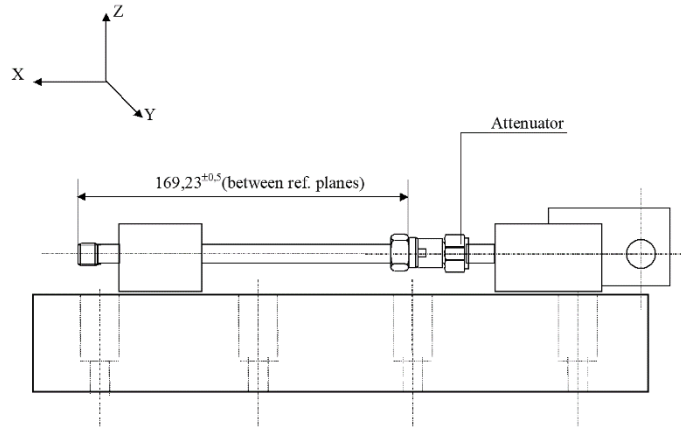

LOADS

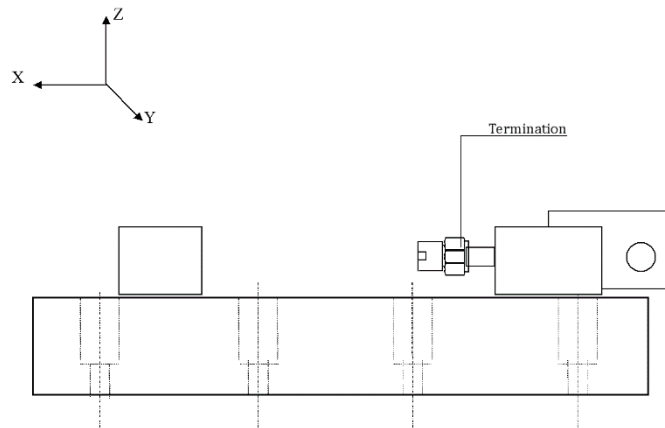

The random vibration testing shall be performed in accordance with the conditions defined below.

- Random Vibration Test Curve:

Envelope: Grms = 50	
Frequency Range	Level
20 to 100 Hz	+6db/Octave
100 to 1000 Hz	1.54g <sup>2</sup> /Hz
1000 to 2000 Hz	-3db/Octave

- Duration: 180s in each of the 3 mutually perpendicular axes defined in the above diagrams.

- **Data Points:**  
During the last cycle in each direction, an electrical measurement shall be made to determine any intermittent contact of 0.5ms or longer duration, or open or short circuiting. After vibration, the components shall be visually inspected and there shall be no evidence of damage.  
Electrical measurements as specified in Intermediate and End-Point Electrical Measurements in the Detail Specification shall be performed. If parameter drift is specified initial measurements also shall be performed.

## 8.6 ELECTRICAL MEASUREMENTS

### 8.6.1 General

Unless otherwise specified in the Detail Specification, the following measurements shall be made in still air, free space and at the standard atmospheric conditions.

#### 8.6.1.1 *Voltage Standing Wave Ratio (VSWR) (Attenuators and Loads)*

The VSWR shall be measured in accordance with the test set-up shown below.

#### VSWR TEST SET-UP (2 PORTS) (ATTENUATORS ONLY)

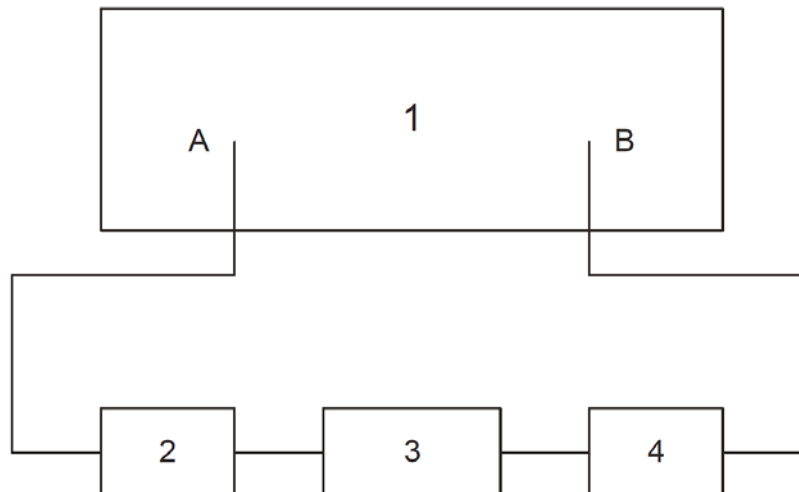

1. Vector network analyser with RF generator and S parameter test set.
2. Cable assembly.
3. Device under test.
4. Cable assembly.

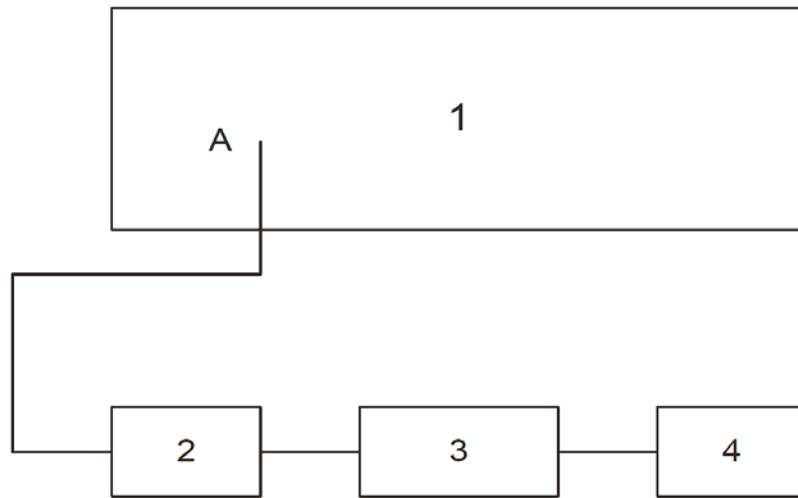
VSWR TEST SET-UP (1 PORT) (ATTENUATORS OR LOADS)

1. Vector network analyser with RF generator and S parameter test set.
2. Cable assembly.
3. Device under test.
4. Precision termination with a reflection coefficient better than 0.017 (-35dB) in the test frequency range.

**NOTE:** 4 is only required for the testing of Attenuators.

Unless otherwise specified, VSWR shall be measured either across the full Frequency Range as specified in Maximum Ratings in the Detail Specification by a swept frequency technique or at equally spaced fixed frequencies (7 minimum) across the frequency range. VSWR shall be measured at both ends for Attenuators.

#### 8.6.1.2 *Attenuation (Attenuators Only)*

Attenuation shall be measured in accordance with the same 2 port test set-up as used for VSWR or equivalent. Unless otherwise specified, Attenuation shall be measured either across the full Frequency Range as specified in Maximum Ratings in the Detail Specification by a swept frequency technique or at equally spaced fixed frequencies (7 minimum) across the frequency range.

#### 8.6.1.3 *Resistance (Loads Only)*

This measurement shall be made as specified in the Detail Specification.

#### 8.6.2 Parameter Drift Values

At each of the relevant data points during Screening Tests, Parameter Drift Values shall be measured as specified in the Detail Specification. All values obtained shall be recorded against serial numbers and the parameter drift calculated.

#### 8.6.3 High and Low Temperatures Electrical Measurements

High and Low Temperatures Electrical Measurements shall be performed as specified in the Detail Specification. All values obtained shall be recorded against serial numbers. Unless otherwise specified measurements shall be performed on a sample of 2 components with 0 failures allowed. In the event of any failure a 100% inspection may be performed.

#### 8.6.4 Room Temperature Electrical Measurements

Room Temperature Electrical Measurements shall be performed as specified in the Detail Specification. All values obtained shall be recorded against serial numbers.

#### 8.6.5 Intermediate and End-Point Electrical Measurements

At each of the relevant data points during Qualification, Periodic Testing and Lot Validation Testing, Intermediate and End-Point Electrical Measurements shall be performed as specified in the Detail Specification. All values obtained shall be recorded against serial numbers and the parameter drift calculated, if specified.

#### 8.7 BURN-IN

Unless otherwise specified the components shall be subjected to a high temperature storage with zero power applied for a period of 168 (+24 -0) hours as specified in Burn-in in the Detail Specification.

After removal from the test chamber the components shall be visually examined and there shall be no evidence of damage.

The data points for electrical measurements, as specified in Parameter Drift Values in the Detail Specification, are at 0 hours (initial) and T (+24 -0) hours (where T is the specified duration). Drift shall be related to the initial measurement.

#### 8.8 EXTERNAL VISUAL INSPECTION AND DIMENSION CHECK

External Visual Inspection shall be performed in accordance with ESCC Basic Specification No. [20500](#).

Dimension Check shall be performed in accordance with ESCC Basic Specification No. [20500](#) and the Detail Specification.

#### 8.9 MECHANICAL SHOCK

Prior to the commencement of testing the components shall be mounted onto a suitable test jig or apparatus, such as that shown in the diagrams of Para. 8.5.2.

The mechanical shock testing shall be performed in accordance with the conditions defined below.

- Mechanical Shock profile:

Each Axis	
Frequency	SRS (g) / Q = 10 (See Notes)
100 Hz	70g
3000 Hz	2000g
10000 Hz	2000g

**NOTES:**

1. Shock Response Spectrum (SRS) specification is defined by a straight line on a log-log plot. SRS computations shall be made with the absolute acceleration time history using the maxi-max technique and a Q-factor  $Q = 10$ . SRS computations shall be made at a minimum of 1/6 octave intervals.
  2. The SRS shall be measured and plotted to 10kHz minimum. However, it is preferable to record the data out to 20kHz (40kHz if possible) for engineering information.
  3. In case of a shock test based on a hammer or real pyrotechnic device, the input load in the direct and cross-talk directions shall be measured using diagonally opposite accelerometers against the device under test. The accelerometers shall be placed being as close as possible to the interface feet of the device under test.
- Number of events: 3 shocks in each of the 3 mutually perpendicular axes defined in the above diagrams.
  - Data Points:  
After shock, the components shall be visually examined and there shall be no evidence of damage.  
Electrical measurements as specified in Intermediate and End-Point Electrical Measurements in the Detail Specification shall be performed. If parameter drift is specified initial measurements also shall be performed.

**8.10 RAPID CHANGE OF TEMPERATURE**

The components shall be subjected to rapid change of temperature as follows:

For Qualification: The number of cycles shall be 100 with 15 minutes at each storage temperature extreme as specified in Maximum Ratings in the Detail Specification.

For Periodic Testing and Lot Validation Testing: The number of cycles shall be 10 with 15 minutes at each storage temperature extreme as specified in Maximum Ratings in the Detail Specification.

Saver connectors shall be connected to the connectors under test during rapid change of temperature.

The components shall be removed from the cold chamber and transferred to the hot chamber in a period which shall be no longer than 3 minutes. Automatic transfer test equipment shall be used if specified in the Detail Specification. The transition time shall include the time of removal from one chamber and the insertion into the second chamber as well as any dwell time at the ambient temperature of the laboratory.

- Data Points:  
On completion of testing and after a recovery period of  $24 \pm 2$  hours at room temperature conditions the components shall be visually examined and there shall be no evidence of damage.  
Electrical measurements as specified in Intermediate and End-Point Electrical Measurements in the Detail Specification shall be performed. If parameter drift is specified initial measurements also shall be performed.

### 8.11 GLITCHES (INSERTION LOSS STABILITY OVER TEMPERATURE) (ATTENUATORS ONLY)

The components shall be subjected to temperature cycling with the following conditions:

- Number of Temperature Cycles: 3 cycles with 15 minutes minimum at each operating temperature extreme as specified in Maximum Ratings in the Detail Specification.
- Temperature transfer slope:  $3 \pm 1^\circ\text{C}/\text{minute}$
- Power Applied During Cycling: 0dBm minimum.
- Operating Frequency: the maximum operating frequency as specified in the Detail Specification, unless otherwise specified.
- Data Points:  
During testing, Insertion Loss shall be continuously monitored and recorded once every 500ms as a minimum or alternatively an analogue recorder may be used.  
The following acceptance criteria shall apply:  
No single Insertion loss discontinuity, step or spike shall exceed 0.05dB over each second.

**NOTE:**

In order for any observed glitch to be considered as a single Insertion Loss discontinuity, step or spike, it shall be evident on more than one temperature cycle. Otherwise it may be ignored.

### 8.12 CLIMATIC SEQUENCE

#### 8.12.1 Dry Heat

The components shall be subjected to Test Ba of IEC Publication No. 60068-2-2 under the following conditions:

- Duration: 2 hours.
- Temperature: Maximum operating temperature as specified in Maximum Ratings in the Detail Specification.
- Data Points  
While still at the specified high temperature and at the end of the period of high temperature, electrical measurements as specified in Intermediate and End-Point Electrical Measurements in the Detail Specification shall be performed.

#### 8.12.2 Damp Heat, Accelerated, First Cycle

Unless otherwise specified in the Detail Specification, the components shall be subjected to Test Db, Severity b (+55 °C), Variant 2, of IEC Publication No. 60068-2-30 for one cycle of 24 hours. After recovery, the components shall be subjected immediately to the Cold test.

#### 8.12.3 Cold

The components shall be subjected to Test Aa of IEC Publication No. 60068-2-1 under the following conditions:

- Duration: 2 hours.
- Temperature: Minimum operating temperature as specified in Maximum Ratings in the Detail Specification.
- Data Points  
While still at the specified low temperature and at the end of the period of low temperature, electrical measurements as specified in Intermediate and End-Point Electrical Measurements in the Detail Specification shall be performed.



#### 8.12.4 Low Air Pressure

The components shall be subjected to Test M of IEC Publication No. 60068-2-13 under the following conditions:

- 1 or 2 minutes at 85mbar.
- Temperature: +15 to +25 °C.

Maximum rated DC Power as specified in Maximum Ratings in the Detail Specification shall be applied to one end of the Attenuator under test while the other end shall be connected to a matched fixed coaxial load, for 1 to 2 minutes immediately after the pressure of 85mbar has been attained. There shall be no evidence of flash-over or breakdown.

When Loads are tested alone, maximum rated DC Power shall be applied directly.

#### 8.12.5 Damp Heat, Accelerated, Remaining Cycles

The components shall be subjected to Test Db, Severity b (+55 °C), Variant 2, of IEC Publication No. 60068-2-30 for 5 cycles of 24 hours.

#### 8.12.6 Final Inspection and Electrical Measurements (Data Points)

On completion of testing and after a recovery period of 1 to 24 hours, the components shall be visually inspected and there shall be no evidence of mechanical damage. Electrical measurements as specified in Intermediate and End-Point Electrical Measurements in the Detail Specification shall be performed. If parameter drift is specified initial measurements also shall be performed.

#### 8.13 COUPLING PROOF TORQUE

The components under test shall be engaged with the applicable mating gauge as specified in the Detail Specification and the coupling nut tightened to the torque specified in the Detail Specification. After 1 minute, the connected pair shall be disconnected.

- Data Points  
On completion of testing, the component shall be visually inspected. The coupling mechanism shall not be dislodged and the interface dimensions of the component shall remain as specified in the Detail Specification.

#### 8.14 MATING AND UNMATING FORCES

##### 8.14.1 Bayonet and Screw Coupling

The component under test shall be mated with its mating gauge as specified in the Detail Specification. During the entire mating or unmating cycle (until the component is fully mated or unmated), the necessary torque shall not exceed the value specified in the Detail Specification.

A screw-coupling component is fully mated with its mating gauge when their reference planes coincide. A bayonet-coupling component is fully mated with its mating gauge when the bayonet studs have passed the detent and their reference planes coincide.

No additional tightening torque shall be applied.

#### 8.14.2 Push-Pull Coupling

The component under test shall be mated with its mating gauge as specified in the Detail Specification. During this engaging cycle, the force necessary to fully mate the component shall not exceed the value specified in the Detail Specification.

Upon completion of mating, an opposite force necessary for unmating shall be applied. The force necessary to fully unmate the component shall not exceed the value specified in the Detail Specification.

#### 8.15 RADIOGRAPHIC INSPECTION

Radiographs shall be taken of the solder joints between the foil and the connector and the pin and centre conductor.

No breaks or cracks shall be present in the solder joints. Criteria for the shape and voids in the solder are defined in the PID.

#### 8.16 CONNECTOR REPEATABILITY (ATTENUATORS ONLY)

The components shall be tested for Connector Repeatability. The following details shall apply:

- Perform 10 complete engagements and separations, both ends separately.
- Rotate Attenuator body through the full 360° with an increment of approximately 36° for each engagement.
- Cleaning of components or reshaping of contacts is not permitted during the test sequence.
- Side-thrust shall not be permitted during the test.
- Data Points

Electrical measurements as specified in Intermediate and End-Point Electrical Measurements in the Detail Specification shall be performed before and after each engagement and separation. As a minimum Attenuation at 3 frequencies shall be performed (1 from each  $\frac{1}{3}$  of the rated frequency range).

#### 8.17 OPERATING LIFE

The components shall be subjected to an Operating Life test of 1000 (+48 -0) hours at the ambient temperature as specified in Operating Life in the Detail Specification.

They shall be tested at maximum rated RF Power as specified in the Detail Specification applied in cycles of 1.5 hours 'on' and 0.5 hours 'off' throughout the test. The 0.5 hours 'off' periods are included in the total test duration. Unless otherwise specified the test frequency shall be 10GHz.

For Qualification, on completion of the 1000-hour operating life, the components shall be subjected to an additional 20 hours at  $T_{amb} = +70^{\circ}\text{C}$ , applied in cycles of 1.5 hours 'on' and 0.5 hours 'off'.

After not less than 1000 hours, the components shall be removed from the chamber and allowed to cool under standard atmospheric conditions prior to final measurements for not less than 1 hour and not more than 2 hours.

The removal from the chamber shall take place at the end of the 'off' period.

- **Mounting**  
The components shall be placed on a rack of insulating material or suspended in the oven. There shall be no undue draught over the components, only natural convection resulting from the hot components may occur.
- **Data Points**  
Prior to testing, initial electrical measurements as specified in Intermediate and End-Point Electrical Measurements in the Detail Specification shall be performed.  
On completion of testing, electrical measurements as specified in Intermediate and End-Point Electrical Measurements in the Detail Specification shall be performed.

8.18 PERMANENCE OF MARKING  
ESCC Basic Specification No. [24800](#).

8.19 RESIDUAL MAGNETISM (GOLD-PLATED WITH COPPER UNDERPLATE VERSION ONLY)  
After submission to a magnetic field of 200 gauss, the components shall exhibit a residual magnetism of less than  $20\gamma$  ( $1\gamma = 10^{-5}$  gauss), measured at 3mm from the component.

8.20 RF LEAKAGE  
The RF Leakage shall be measured across the full Frequency Range as specified in Maximum Ratings the Detail Specification.

The components shall be subjected to RF leakage measurement according to IEC Publication No. 61726. (Reverberating chamber test method).

RF Leakage limits are specified in the Intermediate and End-Point Electrical Measurements in the Detail Specification.

8.21 PEAK POWER  
The component shall be placed in still air and free space at the standard atmospheric conditions. Maximum rated Peak Power (DC condition unless otherwise specified) as specified in Maximum Ratings in the Detail Specification shall be applied 10 times to each end of the Attenuators or to the Load for the specified time. The other end of the Attenuator shall be connected to a matched fixed coaxial load.

- **Data Points**  
After the component has cooled down to standard inspection conditions, electrical measurements as specified in the Intermediate and End-Point Electrical Measurements in the Detail Specification shall be performed.

## 9 DATA DOCUMENTATION

### 9.1 GENERAL

For the qualification, qualification maintenance and procurement for each lot a data documentation package shall exist in a printed or electronic form.

This package shall be compiled from:

- (a) Cover sheet (or sheets).
- (b) List of equipment (testing and measuring).
- (c) List of test references.
- (d) Special In-Process Controls data (Chart F2).
- (e) Screening Tests data (Chart F3).
- (f) Qualification, Periodic Testing and Lot Validation Testing (when applicable) data (Chart F4).
- (g) Failed components list and failure analysis report (when applicable).
- (h) Certificate of Conformity.

Items (a) to (h) inclusive shall be grouped, preferably as subpackages and, for identification purposes, each page shall include the following information:

- ESCC Component Number.
- Manufacturer's name.
- Lot identification.
- Date of establishment of the document.
- Page number.

Whenever possible, documentation should preferably be available in electronic format suitable for reading using a compatible PC. The format supplied shall be legible, durable and indexed. The preferred storage medium is CD-ROM and the preferred file format is PDF.

#### 9.1.1 Qualification and Qualification Maintenance

In the case of qualification or qualification maintenance, the items listed in Para. 9.1(a) to (h) are required.

#### 9.1.2 Component Procurement and Delivery

For all deliveries of components procured to this specification, the following documentation shall be supplied:

- (a) Cover sheet (if all of the information is not included on the Certificate of Conformity).
- (b) Certificate of Conformity (including range of delivered serial numbers).

#### 9.1.3 Additional Documentation

The Manufacturer shall deliver additional documentation containing data and reports to the Orderer, if stipulated in the Purchase Order.

#### 9.1.4 Data Retention/Data Access

If not delivered, all data shall be retained by the Manufacturer for a minimum of 5 years during which time it shall be available for review, if requested, by the Orderer or the ESCC Executive (for qualified components).

## 9.2 COVER SHEET(S)

The cover sheet(s) of the data documentation package shall include as a minimum:

- (a) Reference to the Detail Specification, including issue and date.
- (b) Reference to the applicable ESCC Generic Specification, including issue and date.
- (c) ESCC Component Number and the Manufacturer's part type number.
- (d) Lot identification.
- (e) Range of delivered serial numbers.
- (f) Number of the Purchase Order.
- (g) Information relative to any additions to this specification and/or the Detail Specification.
- (h) Manufacturer's name and address.
- (i) Location of the manufacturing plant.
- (j) Signature on behalf of Manufacturer.
- (k) Total number of pages of the data package.

## 9.3 LIST OF EQUIPMENT USED

A list of equipment used for tests and measurements shall be prepared. Where applicable, this list shall contain inventory number, Manufacturer's type number, serial number, etc. This list shall indicate for which tests such equipment was used.

## 9.4 LIST OF TEST REFERENCES

This list shall include all Manufacturer's references or codes which are necessary to correlate the test data provided with the applicable tests specified in the tables of the Detail Specification.

## 9.5 SPECIAL IN-PROCESS CONTROLS DATA (CHART F2)

A test result summary shall be compiled showing the total number of components submitted to, and the total number rejected after each of the tests. For Contact Engagement and Separation Forces the measurements shall be recorded.

## 9.6 SCREENING TESTS DATA (CHART F3)

A test result summary shall be compiled showing the total number of components submitted to, and the total number rejected after each of the tests. For each test requiring electrical measurements the results shall be recorded against component serial number. Component drift calculations shall be recorded for each specified test against component serial number.

## 9.7 QUALIFICATION, PERIODIC TESTING AND LOT VALIDATION TESTING DATA (CHART F4)

### 9.7.1 Qualification Testing

A test result summary shall be compiled showing the components submitted to and the number rejected after each test in each subgroup. Component serial numbers for each subgroup shall be identified. For each test requiring electrical measurements the results shall be recorded against component serial number. Where a drift value is specified during a test the drift calculation shall be recorded against component serial number.

### 9.7.2 Periodic Testing for Qualification Maintenance

A test result summary shall be compiled showing the components submitted to and the number rejected after each test in each subgroup. Component serial numbers for each subgroup shall be identified. For each test requiring electrical measurements the results shall be recorded against component serial number. Where a drift value is specified during a test the drift calculation shall be recorded against component serial number.

In addition to the full test data a report shall be compiled for each subgroup of Chart F4 to act as the most recent Periodic Testing summary. These reports shall include a list of all tests performed in each subgroup, the ESCC Component Numbers and quantities of components tested, a statement confirming all the results were satisfactory, the date the tests were performed and a reference to the full test data.

### 9.7.3 Lot Validation Testing

A test result summary shall be compiled showing the components submitted to and the number rejected after each test in each subgroup (as applicable). Component serial numbers for each subgroup shall be identified. For each test requiring electrical measurements the results shall be recorded against component serial number. Where a drift value is specified during a test the drift calculation shall be recorded against component serial number.

### 9.8 FAILED COMPONENTS LIST AND FAILURE ANALYSIS REPORT

The failed components list and failure analysis report shall provide full details of:

- (a) The reference and description of the test or measurement performed as defined in this specification and/or the Detail Specification during Special In-Process Controls, Screening Tests and Qualification, Periodic Testing and Lot Validation Testing.
- (b) Traceability information including serial number (if applicable) of the failed component.
- (c) The failed parameter and the failure mode of the component.
- (d) Detailed failure analysis (if requested by the ESCC Executive or Orderer).

### 9.9 CERTIFICATE OF CONFORMITY

A Certificate of Conformity shall be established in accordance with the requirements of ESCC Basic Specification No. [20100](#) or [25400](#).

## 10 DELIVERY

For procurement, for each order, the items forming the delivery are:

- (a) The delivery lot.
- (b) The components used for Lot Validation Testing (as applicable), but not forming part of the delivery lot, if stipulated in the Purchase Order.
- (c) The relevant documentation in accordance with the requirements of Paras. 9.1.2 and 9.1.3.

In the case of a component for which a valid qualification is in force, all data of all components submitted to Lot Validation Testing shall also be copied, when requested, to the ESCC Executive.

For qualification or qualification maintenance, the disposition of the Qualification Test Lot and its related documentation shall be as specified in ESCC Basic Specification No. [20100](#) or [25400](#) and the relevant paragraphs of Section 9 of this specification.

**11 PACKAGING AND DESPATCH**

The packaging and despatch of components to this specification shall be in accordance with the requirements of ESCC Basic Specification No. [20600](#).

12 **CHARTS**

12.1 **CHART F1 - GENERAL FLOW FOR PROCUREMENT**

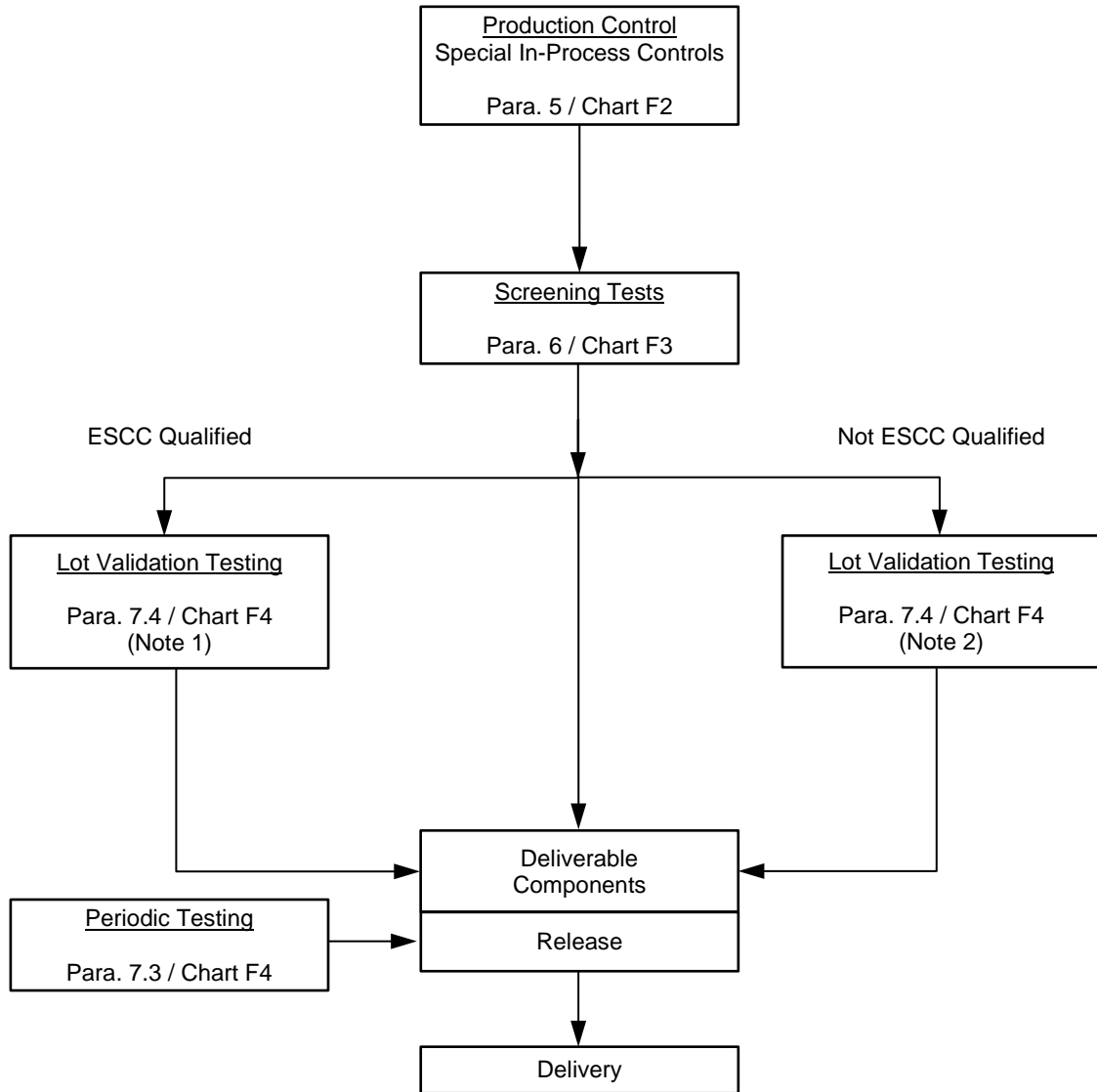

**NOTES:**

1. Lot Validation Testing is not required for qualified components unless specifically stipulated in the Purchase Order.
2. For unqualified components the need for Lot Validation Testing shall be determined by the Orderer and the required testing shall be as stipulated in the Purchase Order (ref. ESCC Basic Specification No. [23100](#)).



12.2 CHART F2 - PRODUCTION CONTROL

COMPONENT LOT MANUFACTURING	
SPECIAL IN-PROCESS CONTROLS	
Para. 5.2.1	Contact Engagement and Separation Forces (1) (2)
Para. 5.2.2	Gold Plate Porosity (1) (2)
Para. 5.2.3	Plating Thickness (1) (2)
Para. 5.2.4	Pre-Encapsulation Inspection
-	Assembly
Para. 5.2.5	Dimension Check (1) (2)
Para. 5.2.6	Weight (3)
TO CHART F3 – SCREENING TESTS	

**NOTES:**

1. Performed on a sample basis.
2. Test may be performed at any point prior to Pre-Encapsulation Inspection.
3. Guaranteed but not tested.

12.3 CHART F3 - SCREENING TESTS

COMPONENTS FROM PRODUCTION CONTROL	
Para. 6.1	Serialisation
Para. 8.4	Thermal Cycling
Para. 8.5.1	Random Vibration
Para. 8.6.2	Parameter Drift Values (Initial Measurements)
Para. 8.7	Burn-in (2)
Para. 8.6.2	Parameter Drift Values (Final Measurements) (2)
Para. 8.6.3	High and Low Temperatures Electrical Measurements (2) (3)
Para. 8.6.4	Room Temperature Electrical Measurements (1) (2)
Para. 8.1	Contact Engagement and Separation Forces (2)
Para. 8.8	External Visual Inspection (2)
Para. 6.4	Check for Lot Failure (4)
TO CHART F4 WHEN APPLICABLE	

**NOTES:**

1. Measurements of Parameter Drift Values need not be repeated in Room Temperature Electrical Measurements.
2. The lot failure criteria of Para. 6.4 apply to this test.
3. Performed on a sample basis.
4. Check for Lot Failure shall take into account all failures that may occur during Screening Tests in accordance with Paras. 8.6.2, 8.6.3, 8.6.4, 8.1, 8.8 subsequent to Burn-in.

12.4 CHART F4 – QUALIFICATION, PERIODIC TESTING AND LOT VALIDATION TESTING

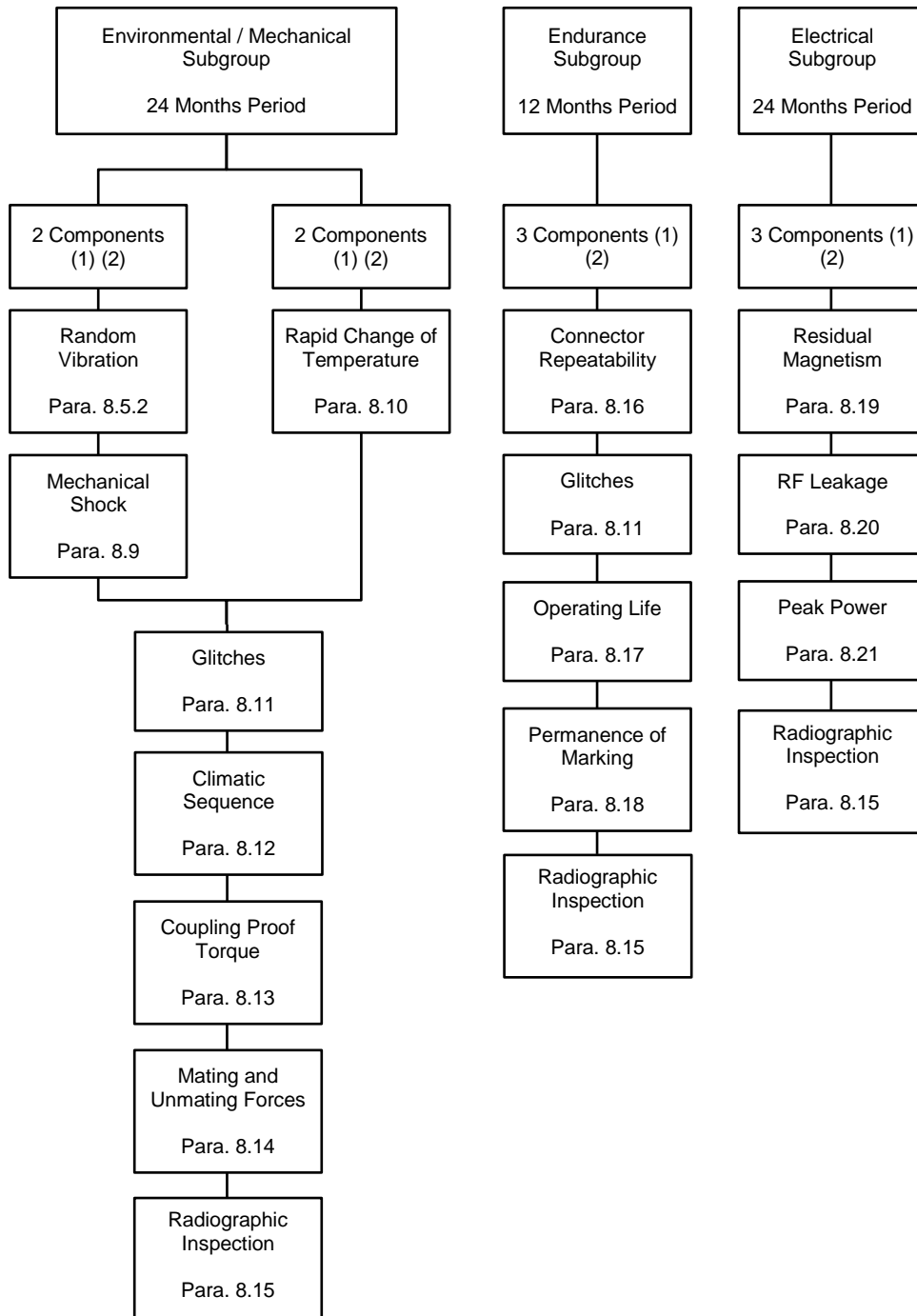

**NOTES:**

1. For distribution within the subgroups see Para. 7.1.2 for qualification and qualification maintenance and Para. 7.4 for Lot Validation Testing.
2. No failures are allowed.