



Page 1 of 18

POWER INDUCTORS, MOULDED, SMD

BASED ON SERIES SESI

ESCC Detail Specification No. 3201/009

Issue 13	November 2016
----------	---------------



Document Custodian: European Space Agency – see <https://escies.org>

LEGAL DISCLAIMER AND COPYRIGHT

European Space Agency, Copyright © 2016. All rights reserved.

The European Space Agency disclaims any liability or responsibility, to any person or entity, with respect to any loss or damage caused, or alleged to be caused, directly or indirectly by the use and application of this ESCC publication.

This publication, without the prior permission of the European Space Agency and provided that it is not used for a commercial purpose, may be:

- copied in whole, in any medium, without alteration or modification.
- copied in part, in any medium, provided that the ESCC document identification, comprising the ESCC symbol, document number and document issue, is removed.

DOCUMENTATION CHANGE NOTICE

(Refer to <https://escies.org> for ESCC DCR content)

DCR No.	CHANGE DESCRIPTION
1017	Specification upissued to incorporate changes per DCR.

TABLE OF CONTENTS

1	GENERAL	5
1.1	SCOPE	5
1.2	APPLICABLE DOCUMENTS	5
1.3	TERMS, DEFINITIONS, ABBREVIATIONS, SYMBOLS AND UNITS	5
1.4	THE ESCC COMPONENT NUMBER AND COMPONENT TYPE VARIANTS	5
1.4.1	The ESCC Component Number	5
1.4.1.1	Characteristics Codes	5
1.4.2	Component Type Variants and Range of Components	6
1.5	MAXIMUM RATINGS	12
1.6	PHYSICAL DIMENSIONS AND TERMINAL IDENTIFICATION	13
1.7	FUNCTIONAL DIAGRAM	14
1.8	MATERIALS AND FINISHES	15
1.8.1	Case	15
1.8.2	Terminals	15
2	REQUIREMENTS	15
2.1	GENERAL	15
2.1.1	Deviations from the Generic Specification	15
2.1.1.1	Deviations from Qualification and Periodic Tests (Chart F4)	15
2.2	MARKING	15
2.3	ELECTRICAL MEASUREMENTS AT ROOM, HIGH AND LOW TEMPERATURES	16
2.3.1	Room Temperature Electrical Measurements	16
2.3.2	High and Low Temperatures Electrical Measurements	16
2.4	INTERMEDIATE AND END-POINT ELECTRICAL MEASUREMENTS	17
2.5	BURN-IN CONDITIONS	18
2.6	OPERATING LIFE CONDITIONS	18

1 GENERAL

1.1 SCOPE

This specification details the ratings, physical and electrical characteristics and test and inspection data for the component type variants and/or the range of components specified below. It supplements the requirements of, and shall be read in conjunction with, the ESCC Generic Specification listed under Applicable Documents.

1.2 APPLICABLE DOCUMENTS

The following documents form part of this specification and shall be read in conjunction with it:

- (a) ESCC Generic Specification No. [3201](#).

1.3 TERMS, DEFINITIONS, ABBREVIATIONS, SYMBOLS AND UNITS

For the purpose of this specification, the terms, definitions, abbreviations, symbols and units specified in ESCC Basic Specification No. [21300](#) shall apply.

1.4 THE ESCC COMPONENT NUMBER AND COMPONENT TYPE VARIANTS

1.4.1 The ESCC Component Number

The ESCC Component Number shall be constituted as follows:

Example: 3201009014L7M

- Detail Specification Reference: 3201009
- Component Type Variant Number: 01 (as required)
- Characteristic code: Inductance Value (4.7μH): 4L7 (as required)
- Characteristic code: Inductance Tolerance (±20%): M (as required)

1.4.1.1 Characteristics Codes

Characteristics to be codified as part of the ESCC Component Number shall be as follows:

- (a) Inductance Value expressed by means of the following codes in accordance with ESCC Basic Specification No. [21700](#). The unit quantity shall be microhenries (μH):

Inductance Value L (μH)	Code
X.X	XLX
XX	XX0
XX 10 ¹	XX1
XX 10 ²	XX2

- (b) Inductance Tolerance expressed by the following codes in accordance with ESCC Basic Specification No. [21700](#):

Tolerance (± %)	Code Letter
10	K
20	M
30	N

1.4.2 Component Type Variants and Range of Components

The component type variants and range of components applicable to this specification are as follows:

Variant Number	Type	Case Description (1)	Terminal Finish (2)	Weight Max (g)
01	SESI 14SR	Size 14 with 2 SMD terminals	Sn60Pb40	4
02	SESI 15SR	Size 15 with 2 SMD terminals	Sn60Pb40	5.5
03	SESI 15WR	Size 15 with 8 Gullwing terminals	Sn60Pb40	6
04	SESI 18WR	Size 18 with 8 Gullwing terminals	Sn60Pb40	11
05	SESI 9.1WR	Size 9.1 with 4 Gullwing terminals	Sn60Pb40	2
06	SESI 22WR	Size 22 with 8 Gullwing terminals	Sn60Pb40	28
07	SESI 32WR	Size 32 with 16 Gullwing terminals	Sn60Pb40	58
08	SESI 32PR	Size 32 with 16 Pin terminals	Sn60Pb40	58

RANGE OF COMPONENTS – VARIANT 01 (SESI 14SR)

Inductance (3) L (μH)	Tolerance ± %	Rated DC Current I _R (A)	Loaded Inductance at I _R (3, 4) L _R (μH)	Peak Current (5) I _P (A)	Max. DC Resistance R _{DC} (mΩ)
3.3	20	5.8	2.3	8	15
4.7	20	5.4	3.3	6.9	17.5
6	20	4.3	4.2	5.7	26.5
8.2	20	3.7	5.7	5.2	42
10	20	3.3	7	4.6	47
15	20	2.7	10.5	3.8	90
22	20	2.2	15.4	3	110
33	20	1.8	23.1	2.5	170
47	10	1.6	32.9	2.1	200
56	10	1.5	39.2	1.9	240
68	10	1.3	47.6	1.7	290
82	10	1.2	57.4	1.5	315
100	10	1.1	70	1.4	440
120	10	1	84	1.3	500
150	10	0.9	105	1.1	645
180	10	0.83	126	1	740
220	10	0.72	154	1	980
330	10	0.57	231	0.8	1575

RANGE OF COMPONENTS – VARIANTS 02 AND 03 (SESI 15SR, SESI 15WR)

Inductance (3) L (μH)	Tolerance ± %	Rated DC Current I _R (A)	Loaded Inductance at I _R (3, 4) L _R (μH)	Peak Current (5) I _P (A)	Max. DC Resistance R _{DC} (mΩ)
1.5	30	14	0.9	19	5
1.8	30	10	1.05	14	5
2.7	20	8.2	1.9	11.5	6.5
4.9	20	6	3.4	8.5	11
6.4	20	5.3	4.5	7.5	12
8	20	4.8	5.6	6.5	16
12	20	4	8.4	5.5	23
16	20	3.4	11.2	4.5	27
18	20	3.1	12.6	4.2	29
21	20	2.9	14.7	4	36
27	20	2.6	18.9	3.5	44
33	20	2.3	23	3.2	59
48	10	1.9	33	2.7	72
56	10	1.8	39	2.5	82
68	10	1.6	47	2.2	110
82	10	1.5	57	2.1	120
100	10	1.35	70	1.9	155
120	10	1.2	84	1.7	180
150	10	1.1	105	1.5	230
220	10	0.9	154	1.3	355
330	10	0.74	231	1	630
1000	10	0.38	800	0.5	2130
2300	10	0.28	1900	0.36	4400

RANGE OF COMPONENTS – VARIANT 04 (SESI 18WR)

Inductance (3) L (μH)	Tolerance ± %	Rated DC Current I _R (A)	Loaded Inductance at I _R (3, 4) L _R (μH)	Peak Current (5) I _P (A)	Max. DC Resistance R _{DC} (mΩ)
6.8	20	9.8	4.2	13.6	7.5
8.2	20	8.3	5.7	11.5	9
11	20	7.2	7.7	10	12
15	20	6.35	10.5	8.9	15
18	20	5.7	12.6	7.9	17
22	20	5.1	15.4	7.2	20
27	20	4.7	18.9	6.5	25
37	10	4	25.9	5.6	29
49	10	3.5	34.3	4.8	45
56	10	3.3	39	4.6	48
70	10	2.9	49	4.1	65
86	10	2.6	60	3.7	72
100	10	2.4	70	3.3	75
120	10	2.2	84	3.1	115
150	10	1.95	105	2.7	125
180	10	1.8	126	2.6	175
220	10	1.6	154	2.3	210
330	10	1.34	231	1.9	250
470	10	0.9	376	1.35	600
1000	10	0.38	800	0.5	2130
2300	10	0.28	1900	0.36	4400

RANGE OF COMPONENTS – VARIANT 05 (SESI 9.1WR)

Inductance (3) L (μH)	Tolerance ± %	Rated DC Current I _R (A)	Loaded Inductance at I _R (3, 4) L _R (μH)	Peak Current (5) I _P (A)	Max. DC Resistance R _{DC} (mΩ)
1	30	6	0.6	11	8.5
1.5	30	5.4	0.9	9.5	11.5
2	30	4.3	1.4	8.2	17
2.6	20	3.6	1.8	7	23
3.4	20	3	2.4	6.2	35
4.3	20	2.8	3	5.5	40
6.2	20	2.3	4.3	4.3	59
8.5	20	1.9	6	3.7	87
10	20	1.85	7	3.4	93
15	20	1.5	10.5	2.8	140
18	20	1.27	12.6	2.5	192
22	20	1.21	15.4	2.3	215
26	20	1.03	18.2	2.14	290
33	10	0.92	23.1	1.9	350
47	10	0.8	32.9	1.6	470
66	10	0.73	46.2	1.3	565
81	10	0.63	56.7	1.21	745
100	10	0.6	70	1.1	795
150	10	0.53	105	0.8	750
220	10	0.43	154	0.7	1165
330	10	0.36	231	0.6	1475
470	10	0.3	329	0.5	2220
680	10	0.25	477	0.4	3255
1000	10	0.2	700	0.34	5865
6800	10	0.045	5440	0.067	28000

RANGE OF COMPONENTS – VARIANT 06 (SESI 22WR)

Inductance (3) L (μH)	Tolerance ± %	Rated DC Current I _R (A)	Loaded Inductance at I _R (3, 4) L _R (μH)	Peak Current (5) I _P (A)	Max. DC Resistance R _{DC} (mΩ)
7	20	18.9	3.8	24	5
7.7	20	16	5.4	20	4.5
10	20	13.8	7	17.7	5.5
13	20	12	9.1	15.6	7
19	20	10.9	11.5	14	11
24	20	8.4	16.8	11.5	13
33	20	7.7	23	9.8	20
47	10	5.7	37.6	8	16
64	10	5	51.2	7	21
82	10	4.3	65.6	6.1	24
100	10	3.9	80	5.5	30
150	10	3.2	120	4.7	44
210	10	2.7	168	3.8	70
340	10	2.1	272	3	120
470	10	1.8	376	2.5	180
680	10	1.5	544	2.1	220
820	10	1.4	656	2	300
1000	10	1.2	800	1.8	330
1500	10	1.1	1200	1.4	500
2200	10	0.8	1760	1.2	760

RANGE OF COMPONENTS – VARIANT 07 AND 08 (SESI 32WR, SESI 32PR)

Inductance (3) L (μH)	Tolerance ± %	Rated DC Current I _R (A)	Loaded Inductance at I _R (3, 4) L _R (μH)	Peak Current (5) I _P (A)	Max. DC Resistance R _{DC} (mΩ)
4.9	30	24	3	27.6	1.9
12	30	15.5	7.3	17.8	4.4
22	30	11.5	13.5	13.2	7.8
36	20	9.2	21.75	10.6	13
53	20	7.6	34.2	8.7	18
73	10	6.5	47.2	7.5	25
84	10	6	68	6.9	29
110	10	5.3	88	6.1	38.5
150	10	4.5	123	5.2	54.5
200	10	3.9	163	4.5	70
260	10	3.4	210	3.9	89.5
350	10	3	281	3.4	117.5
470	10	2.5	385	2.9	160
620	10	2.2	505	2.5	221
820	10	1.9	670	2.2	254
1000	10	1.7	826	2	353
2000	10	1.2	1650	1.4	665
4700	10	0.8	3760	0.92	1300

NOTES:

1. See Physical Dimensions and Terminal Identification.
2. See Materials and Finishes for details.
3. See Room Temperature Electrical Measurements and High and Low Temperature Electrical Measurements (as applicable) for test conditions.
4. Minimum value when the inductance is measured with Rated DC Current, I_R, applied.
5. Peak current is the maximum current for a square pulse of duration < 10s.

1.5 MAXIMUM RATINGS

The maximum ratings shall not be exceeded at any time during use or storage.

Maximum ratings shall only be exceeded during testing to the extent specified in this specification and when stipulated in Test Methods and Procedures of the ESCC Generic Specification.

Characteristics	Symbols	Maximum Ratings	Units	Remarks
Rated DC Current	I_R	Note 1	A	
Dielectric Withstanding Voltage	DWV	500	Vrms	
Peak Current	I_P	Note 1		Square pulse < 10s
Operating Temperature Range	T_{op}	-55 to +125	°C	T_{amb}
Storage Temperature Range	T_{stg}	-55 to +140	°C	
Soldering Temperature	T_{sol}	+260	°C	Note 2

NOTES:

1. See Component Type Variants and Range of Components for values.
2. Duration 5 seconds maximum, the same terminal shall not be resoldered until 3 minutes have elapsed.

1.6 PHYSICAL DIMENSIONS AND TERMINAL IDENTIFICATION

VARIANTS 01, 02

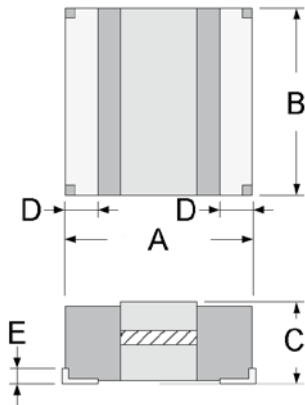

VARIANTS 03, 04, 06 (Note 1)

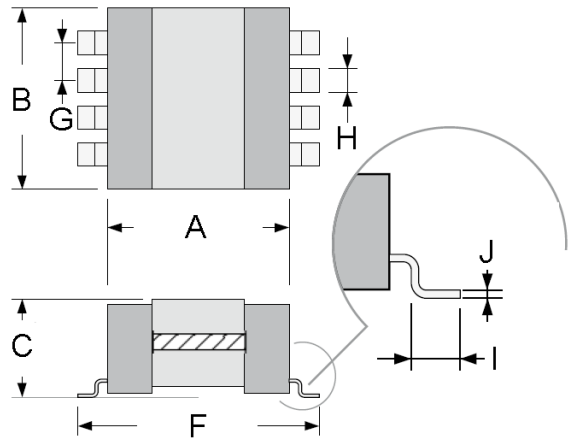

VARIANT 05 (Note 1)

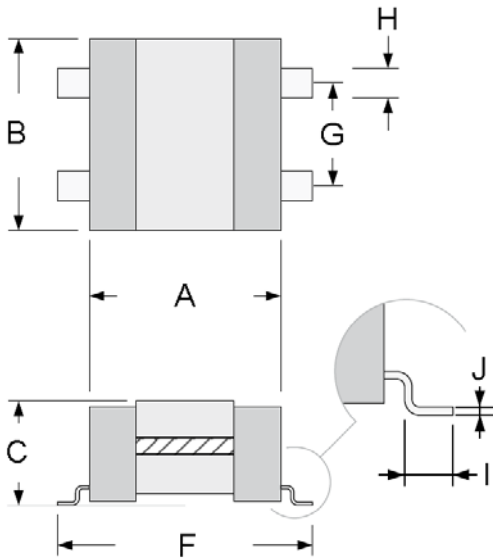

VARIANT 07 (Note 1)

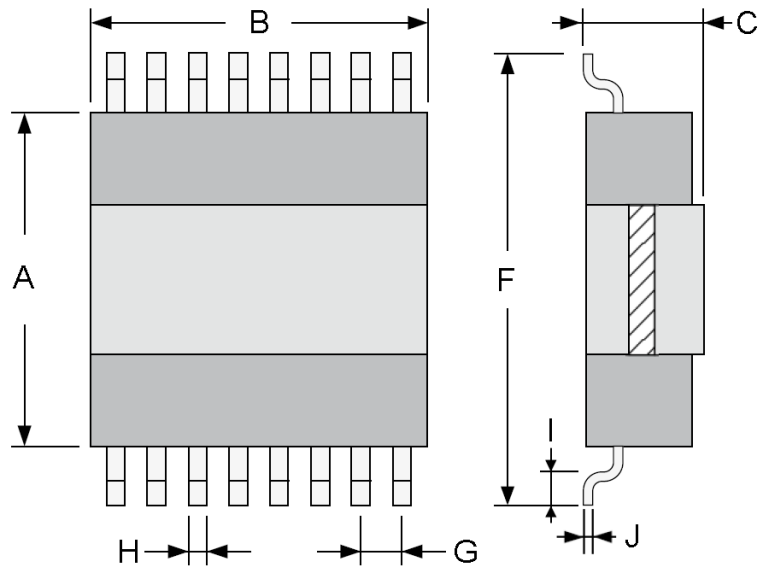

VARIANT 08 (NOTE 1)

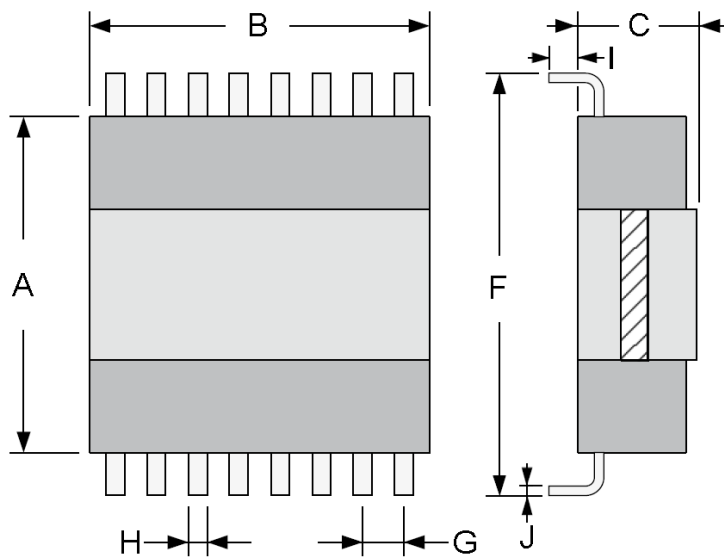

Symbols	Dimensions (mm)															
	Variant 01		Variant 02		Variant 03		Variant 04		Variant 05		Variant 06		Variant 07		Variant 08	
	Min	Max	Min	Max	Min	Max	Min	Max	Min	Max	Min	Max	Min	Max	Min	Max
A	15.7	16.3	15.7	16.3	16	16.5	21.7	22.3	10	10.6	30.4	31.2	42.1	42.9	42.1	42.9
B	-	16	-	16	-	16	-	19.8	-	10.7	-	23.5	-	33.5	-	33.5
C	-	5.4	-	7.4	-	7.9	-	8.9	-	5.8	-	12.2	-	13.7	-	13.7
D	2.3	-	2.3	-	-	-	-	-	-	-	-	-	-	-	-	-
E	1	1.5	1	1.5	-	-	-	-	-	-	-	-	-	-	-	-
F	-	-	-	-	21.1	22	25.1	26	12.8	13.4	34.4	35.3	52	53.5	48.1	48.5
G	-	-	-	-	3.7	3.9	3.7	3.9	5.6	5.8	3.7	3.9	3.7	3.9	3.7	3.9
H	-	-	-	-	1	1.2	1.9	2.1	1.3	1.5	1.9	2.1	0.8	1	0.8	1
I	-	-	-	-	1.3	1.6	1.3	1.6	0.9	1.3	1.3	1.6	2.15	2.35	4	-
J	-	-	-	-	0.2	-	0.2	-	0.2	-	0.2	-	0.4	0.7	0.4	0.7

NOTES:

- Terminal identification: All terminals on each side of the body are connected together.

1.7 FUNCTIONAL DIAGRAM

VARIANTS 01, 02



VARIANTS 03, 04, 06

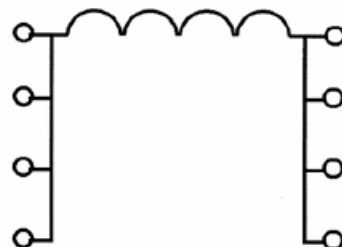

VARIANT 05



VARIANTS 07, 08

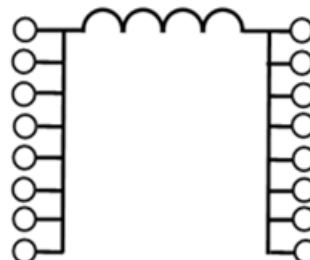

1.8 MATERIALS AND FINISHES

1.8.1 Case

As a minimum, a resin moulding shall ensure the inductor's protection.

1.8.2 Terminals

The terminal material shall be brass, plated with 2 to 4µm of nickel or copper. The finish shall be Sn60Pb40.

2 REQUIREMENTS

2.1 GENERAL

The complete requirements for procurement of the components specified herein are as stated in this specification and the ESCC Generic Specification. Permitted deviations from the Generic Specification, applicable to this specification only, are listed below.

Permitted deviations from the Generic Specification and this Detail Specification, formally agreed with specific Manufacturers on the basis that the alternative requirements are equivalent to the ESCC requirement and do not affect the component's reliability, are listed in the appendices attached to this specification.

2.1.1 Deviations from the Generic Specification

2.1.1.1 *Deviations from Qualification and Periodic Tests (Chart F4)*

- (a) Temperature Rise: Ambient test temperature shall be +90 ±5°C.
- (b) Immersion: shall not be performed.
- (c) Moisture Resistance, Polarisation: there shall be no polarising voltage applied during test.

2.2 MARKING

The marking of all components delivered to this specification shall be in accordance with the requirements of ESCC Basic Specification No. [21700](#). When the component is too small to accommodate all of the marking specified, as much as space permits shall be marked and the marking information, in full, shall accompany each component in its primary package.

The information to be marked and the order of precedence, shall be as follows:

- (a) The ESCC qualified components symbol (for ESCC qualified components only).
- (b) The ESCC Component Number.
- (c) Traceability information.

2.3 ELECTRICAL MEASUREMENTS AT ROOM, HIGH AND LOW TEMPERATURES

2.3.1 Room Temperature Electrical Measurements

The measurements shall be performed at $T_{amb} = +22 \pm 3 \text{ }^\circ\text{C}$.

Characteristics	Symbols	Test Method and Conditions	Tolerance (\pm %)	Limits		Units
				Min	Max	
Inductance	L	ESCC No. 3201 f = 100kHz I = 0A _{dc} V = 250mV	10	0.9L (Note 1)	1.1L (Note 1)	μH
			20	0.8L (Note 1)	1.2L (Note 1)	
			30	0.7L (Note 1)	1.3L (Note 1)	
Loaded Inductance	L _R	ESCC No. 3201 f = 100kHz I = I _R (Note 1) V = 250mV	All	Note 1	-	μH
DC Resistance	R _{DC}	ESCC No. 3201	All	-	Note 1	m Ω
Insulation Resistance	R _I	ESCC No. 3201 V = 500V _{dc}	All	1000	-	M Ω

NOTES:

1. See Component Type Variants and Range of Components for values.

2.3.2 High and Low Temperatures Electrical Measurements

Characteristics	Symbols	Test Method and Conditions (Note 1)	Limits		Unit
			Min	Max	
Loaded Inductance	L _R	ESCC No. 3201 $T_{amb} = +110(+0 -5)^\circ\text{C}$ and $-55(+5 -0)^\circ\text{C}$ f = 100kHz I = I _R (Note 2) V = 250mV	Note 2	-	μH

NOTES:

1. The measurements shall be performed on a sample of 5 components from each lot with 0 failures allowed. In the event of any failure a 100% inspection may be performed.
2. See Component Type Variants and Range of Components for values.

2.4 INTERMEDIATE AND END-POINT ELECTRICAL MEASUREMENTS

Unless otherwise specified, the measurements shall be performed at $T_{amb} = +22 \pm 3^{\circ}\text{C}$.

Unless otherwise specified the test methods and test conditions shall be as per the corresponding test defined in Room Temperature Electrical Measurements.

Test Reference per ESCC No. 3201	Characteristics	Symbols	Limits		Units
			Min	Max	
Thermal Shock	DC Resistance	R_{DC}	Note 1		m Ω
Barometric Pressure Whilst at low pressure:	Dielectric Withstanding Voltage (2)	DWV	500	-	Vrms
	DWV Leakage Current (3)	I_L	-	100	μA
Temperature Rise Initial Measurements	Test temperature: $T_{amb} = +90 \pm 5^{\circ}\text{C}$ DC Resistance (at 0.1I _r)	R_{DC}	Record Value		m Ω
	Final Measurements (within 30s of the removal of power)	DC Resistance (at I _R) Temperature Rise	R_{DC} ΔT	Record Value - 25	m Ω $^{\circ}\text{C}$
Overload	DC Resistance	R_{DC}	Note 1		m Ω
	Insulation Resistance	R_i	1000	-	M Ω
	Dielectric Withstanding Voltage (2)	DWV	500	-	Vrms
	DWV Leakage Current (3)	I_L	-	100	μA
Resistance to Soldering Heat	Inductance	L	Note 1		μH
	DC Resistance	R_{DC}	Note 1		m Ω
	Dielectric Withstanding Voltage (2)	DWV	500	-	Vrms
	DWV Leakage Current (3)	I_L	-	100	μA
Moisture Resistance Within 30 min of removal from conditioning:	Dielectric Withstanding Voltage (2)	DWV	500	-	Vrms
	DWV Leakage Current (3)	I_L	-	100	μA
	Insulation Resistance	R_i	1000	-	M Ω
Within 1 hour of previous measurements:	Inductance	L	Note 1		μH
	DC Resistance	R_{DC}	Note 1		m Ω

Test Reference per ESCC No. 3201	Characteristics	Symbols	Limits		Units
			Min	Max	
Operating Life Initial Measurements (0 hour)	Inductance	L	Note 1		μH
Intermediate Measurements (1000 hours)(after 30 min recovery)	Dielectric Withstanding Voltage (2)	DWV	500	-	Vrms
	DWV Leakage Current (3)	I _L	-	100	μA
	Inductance Change	ΔL/L	-10	+10	%
Final Measurements (2000 hours)(after 30 min recovery)	Dielectric Withstanding Voltage (2)	DWV	500	-	Vrms
	DWV Leakage Current (3)	I _L	-	100	μA
	Inductance Change	ΔL/L	-10	+10	%
	DC Resistance	R _{DC}	Note 1		mΩ
	Insulation Resistance	R _I	1000	-	MΩ

NOTES:

1. See Component Type Variants and Range of Components for values.
2. Test method and conditions per ESCC No. 3201.
3. Measured during Dielectric Withstanding Voltage.

2.5

BURN-IN CONDITIONS

Characteristics	Symbols	Test Conditions	Units
Ambient Temperature	T _{amb}	+125 (+0 -3)	°C

NOTES:

1. After Burn-in, the components shall be removed from the chamber and allowed to cool under normal atmospheric conditions for recovery for 24 hours minimum.

2.6

OPERATING LIFE CONDITIONS

Characteristics	Symbols	Test Conditions	Units
Ambient Temperature	T _{amb}	+125 (+0 -3)	°C
DC Current	I	I _R (Note 1)	mA

NOTES:

1. See Component Type Variants and Range of Components for values.