



**RELAY, ELECTROMAGNETIC, LATCHING, 28VDC,  
2A, 2PDT, HALF-SIZE CRYSTAL CAN**

**ESCC Detail Specification No. 3602/003**

***DRAFT***

Issue 6 Draft E	August 2013
-----------------	-------------



### **LEGAL DISCLAIMER AND COPYRIGHT**

European Space Agency, Copyright © 2013. All rights reserved.

The European Space Agency disclaims any liability or responsibility, to any person or entity, with respect to any loss or damage caused, or alleged to be caused, directly by the use and application of this ESCC publication.

This publication, without prior permission of the European Space Agency and provided it is not used for a commercial purpose, may be:

- copied in whole, in any medium, without alteration or modification.
- copied in part, in any medium, provided that the ESCC document identification, comprising the ESCC symbol, document number and document issue, is removed.

**DOCUMENTATION CHANGE NOTICE**

(Refer to <https://escies.org> for ESCC DCR content)

DCR No.	CHANGE DESCRIPTION
704	Specification updated to incorporate editorial and technical changes per DCR. Specification converted to MSWORD. Changes in presentation are possible.

**TABLE OF CONTENTS**

1	GENERAL	5
1.1	SCOPE	5
1.2	APPLICABLE DOCUMENTS	5
1.3	TERMS, DEFINITIONS, ABBREVIATIONS, SYMBOLS AND UNITS	5
1.4	THE ESCC COMPONENT NUMBER AND COMPONENT TYPE VARIANTS	5
1.4.1	The ESCC Component Number	5
1.4.1.1	Characteristics and/or Ratings Codes	5
1.4.2	Component Type Variants and Range of Components	6
1.5	MAXIMUM RATINGS	7
1.6	PHYSICAL DIMENSIONS AND TERMINAL IDENTIFICATION	8
1.6.1	Plain Case (No Mount) and Solder Pin Terminals (Variant 01)	8
1.6.2	Raised Vertical Flange Mount and Solder Pin Terminals (Variant 02)	9
1.6.3	Horizontal Flange Mount and Solder Hook Terminals (Variant 03)	10
1.6.4	Horizontal Flange Mount and Solder Pin Terminals (Variant 04)	11
1.6.5	Plain Case (No Mount) and Solder Hook Terminals (Variant 05)	12
1.6.6	Raised Vertical Flange Mount and Solder Hook Terminals (Variant 06)	13
1.6.7	Plain Case (No Mount) and Long Solder Pin Terminals (Variants 09, 10)	14
1.7	FUNCTIONAL DIAGRAM	15
1.8	MATERIALS AND FINISHES	15
1.8.1	Case	15
1.8.2	Terminals	15
2	REQUIREMENTS	15
2.1	GENERAL	15
2.1.1	Deviations from the Generic Specification	15
2.2	MARKING	15
2.3	TERMINAL STRENGTH	16
2.4	ELECTRICAL MEASUREMENTS AT ROOM, HIGH AND LOW TEMPERATURES	16
2.4.1	Room Temperature Electrical Measurements	16
2.4.2	High and Low Temperatures Electrical Measurements	17
2.4.3	Notes to Electrical Measurements Tables	17
2.5	PARAMETER DRIFT VALUES	18
2.6	INTERMEDIATE AND END-POINT ELECTRICAL MEASUREMENTS	18
2.7	RUN-IN CONDITIONS	23
	APPENDIX A	24

## 1 GENERAL

### 1.1 SCOPE

This specification details the ratings, physical and electrical characteristics, and test and inspection data for the component type variants and/or the range of components specified below. It supplements the requirements of, and shall be read in conjunction with, the ESCC Generic Specification listed under Applicable Documents.

### 1.2 APPLICABLE DOCUMENTS

The following documents form part of this specification and shall be read in conjunction with it:

(a) ESCC Generic Specification No. 3602.

### 1.3 TERMS, DEFINITIONS, ABBREVIATIONS, SYMBOLS AND UNITS

For the purpose of this specification, the terms, definitions, abbreviations, symbols and units specified in ESCC Basic Specification No. 21300 shall apply.

### 1.4 THE ESCC COMPONENT NUMBER AND COMPONENT TYPE VARIANTS

#### 1.4.1 The ESCC Component Number

The ESCC Component Number shall be constituted as follows:

Example: 36020030126V

- Detail Specification Reference: 3602003
- Component Type Variant Number: 01 (as required)
- Characteristic code: Rated Coil Voltage (26.5Vdc): 26V (as required)

##### 1.4.1.1 *Characteristics and/or Ratings Codes*

Characteristics and/or ratings to be codified as part of the ESCC Component Number shall be as follows:

(a) Rated Coil Voltage expressed by means of the following codes:

Rated Coil Voltage (Vdc)	Code
26.5	26V
12	12V
6	6V

#### 1.4.2 Component Type Variants and Range of Components

The component type variants and range of components applicable to this specification are as follows:

Variant Number	Case and Terminal Description (Note 1)	Rated Coil Voltage (Vdc)	Weight max (g)
01	Plain Case (No Mount) Solder Pin Terminals	26.5, 12, 6	8.5
02	Raised Vertical Flange Mount Solder Pin Terminals	26.5, 12, 6	8.5
03	Horizontal Flange Mount Solder Hook Terminals	26.5, 12, 6	8.5
04	Horizontal Flange Mount Solder Pin Terminals	26.5, 12, 6	8.5
05	Plain Case (No Mount) Solder Hook Terminals	26.5, 12, 6	8.5
06	Raised Vertical Flange Mount Solder Hook Terminals	26.5, 12, 6	8.5
09	Plain Case (No Mount) Long Solder Pin Terminals (6.53mm)	26.5, 12, 6	8.5
10	Plain Case (No Mount) Long Solder Pin Terminals (5.78mm)	26.5, 12, 6	8.5

**NOTES:**

1. See Physical Dimensions and Terminal Identification.

1.5 MAXIMUM RATINGS

The maximum ratings shall not be exceeded at any time during use or storage.

Maximum ratings shall only be exceeded during testing to the extent specified in this specification and when stipulated in Test Methods and Procedures of the ESCC Generic Specification.

Characteristics	Symbols	Maximum Ratings	Units	Remarks
Coil Voltage Range	$V_{CR}$	25 to 32 11 to 15 5.5 to 7.5	Vdc	Rated Coil Voltage: 26.5Vdc Rated Coil Voltage: 12Vdc Rated Coil Voltage: 6Vdc
Rated Resistive Load Contact Current	$I_{CR}$	2	A	28Vdc resistive Note 1
Rated Inductive Load Contact Current	$I_{CL}$	400	mA	28Vdc inductive Inductance: 320mH Note 1
Overload Current	$I_{OVERLOAD}$	4	A	28Vdc resistive
Operating Temperature Range	$T_{op}$	-65 to +125	°C	$T_{amb}$
Storage Temperature Range	$T_{stg}$	-65 to +125	°C	$T_{amb}$
Soldering Temperature	$T_{sol}$	+260	°C	Note 2

**NOTES:**

1. Relays should not be used in change-over mode where the potential difference between stationary contacts is greater than 10V and the switched current is greater than 100mA.
2. Duration 10 seconds maximum at a distance not less than 1.5mm from the device body. The same terminal shall not be resoldered until 3 minutes have elapsed.

1.6 PHYSICAL DIMENSIONS AND TERMINAL IDENTIFICATION

1.6.1 Plain Case (No Mount) and Solder Pin Terminals (Variant 01)

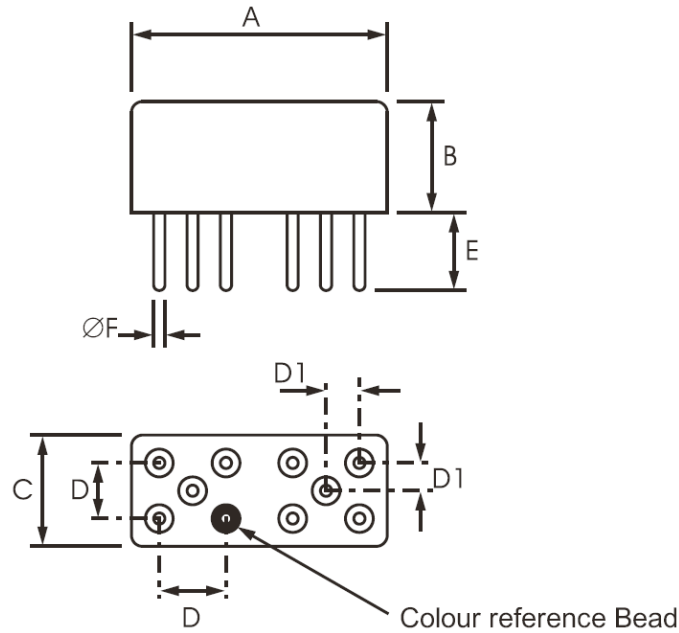

Symbols	Dimensions (mm)	
	Min	Max
A	-	20.57
B	-	10.41
C	-	10.41
D	4.95	5.21
D1	2.4	2.7
E	4.24	5.4
ØF	0.66	0.86

**NOTES:**

- Terminal identification is specified by reference to the colour reference bead. See Functional Diagram.



1.6.2 Raised Vertical Flange Mount and Solder Pin Terminals (Variant 02)

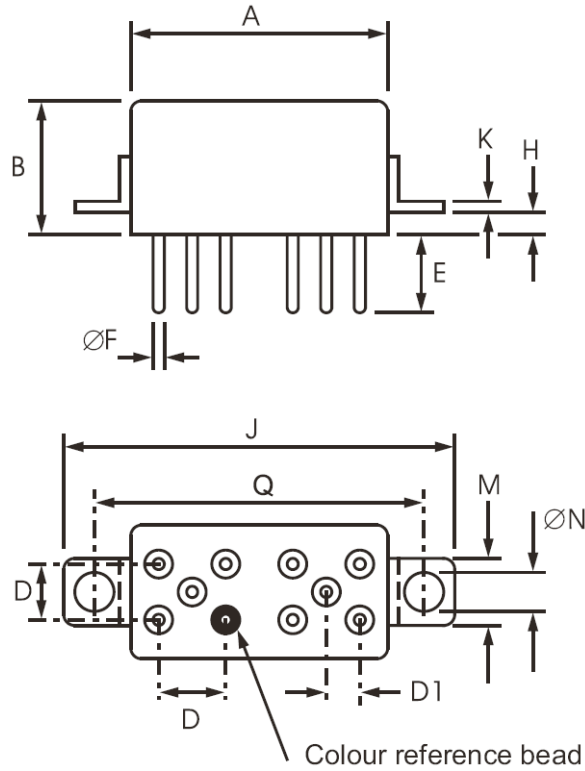

Symbols	Dimensions (mm)	
	Min	Max
A	-	20.57
B	-	10.41
C	-	10.41
D	4.95	5.21
D1	2.4	2.7
E	4.24	5.4
ØF	0.66	0.86
H	3.1	3.3
J	-	32.9
K	0.5	0.8
M	6.22	8.1
ØN	3	3.55
Q	26.6	27.4

**NOTES:**

- Terminal identification is specified by reference to the colour reference bead. See Functional Diagram.

1.6.3 Horizontal Flange Mount and Solder Hook Terminals (Variant 03)

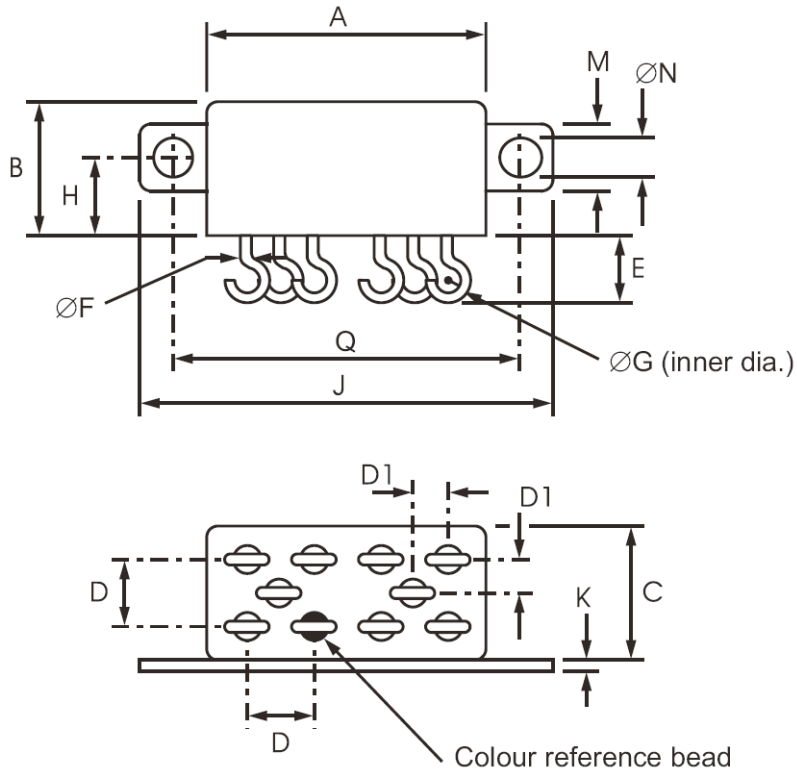

Symbols	Dimensions (mm)	
	Min	Max
A	-	20.57
B	-	10.41
C	-	10.41
D	4.95	5.21
D1	2.4	2.7
E	4.11	4.83
ØF	0.66	0.86
ØG	-	1.8
H	5.97	6.73
J	-	32.64
K	0.38	0.9
M	6.22	8
ØN	3	3.55
Q	26.8	27.2

**NOTES:**

- Terminal identification is specified by reference to the colour reference bead. See Functional Diagram.

1.6.4 Horizontal Flange Mount and Solder Pin Terminals (Variant 04)

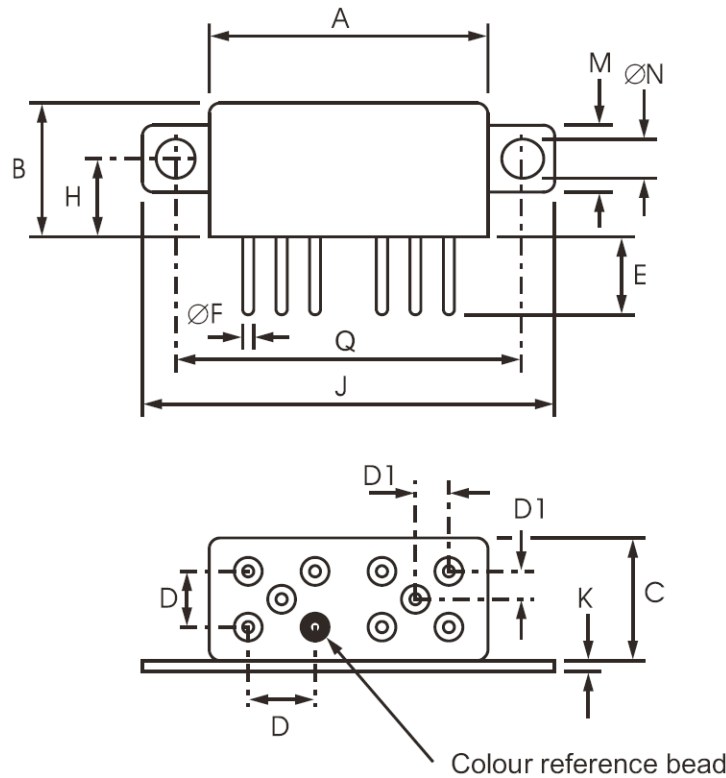

Symbols	Dimensions (mm)	
	Min	Max
A	-	20.57
B	-	10.41
C	-	10.41
D	4.95	5.21
D1	2.4	2.7
E	4.24	5.4
ØF	0.66	0.86
H	5.97	6.73
J	-	32.64
K	0.38	0.9
M	6.22	8
ØN	3	3.55
Q	26.8	27.2

**NOTES:**

1. Terminal identification is specified by reference to the colour reference bead. See Functional Diagram.

1.6.5 Plain Case (No Mount) and Solder Hook Terminals (Variant 05)

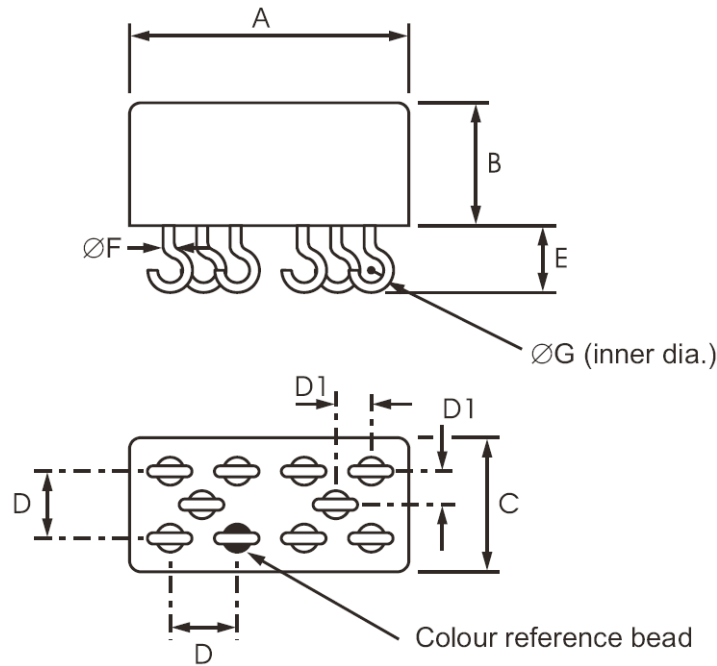

Symbols	Dimensions (mm)	
	Min	Max
A	-	20.57
B	-	10.41
C	-	10.41
D	4.95	5.21
D1	2.4	2.7
E	4.11	4.83
ØF	0.66	0.86
ØG	-	1.8

**NOTES:**

1. Terminal identification is specified by reference to the colour reference bead. See Functional Diagram.

1.6.6 Raised Vertical Flange Mount and Solder Hook Terminals (Variant 06)

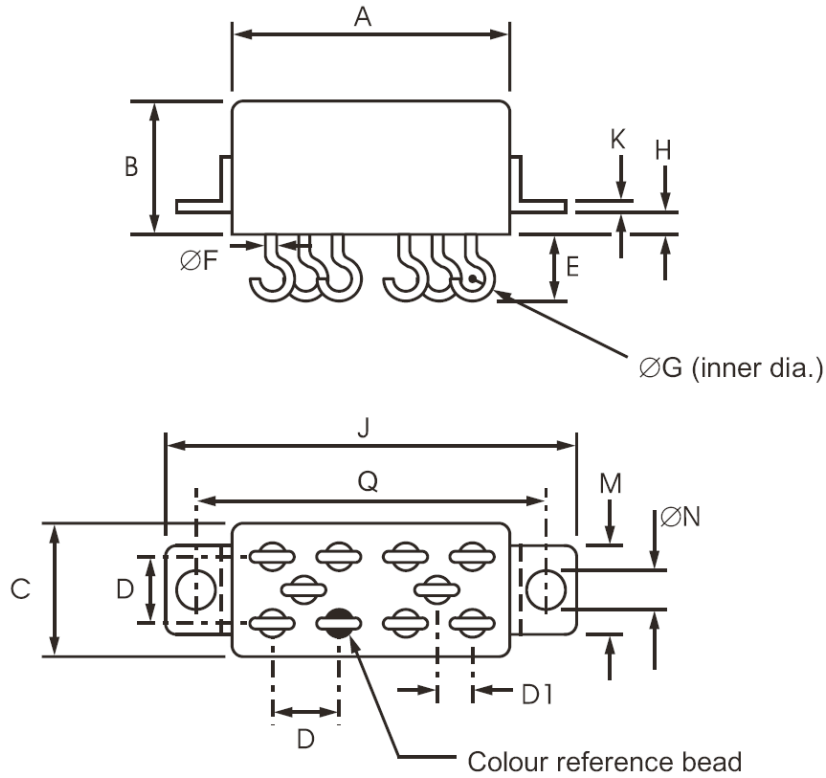

Symbols	Dimensions (mm)	
	Min	Max
A	-	20.57
B	-	10.41
C	-	10.41
D	4.95	5.21
D1	2.4	2.7
E	4.11	4.83
ØF	0.66	0.86
ØG	-	1.8
H	3.1	3.3
J	-	32.9
K	0.5	0.8
M	6.22	8.1
ØN	3	3.55
Q	26.6	27.4

**NOTES:**

1. Terminal identification is specified by reference to the colour reference bead. See Functional Diagram.

1.6.7 Plain Case (No Mount) and Long Solder Pin Terminals (Variants 09, 10)

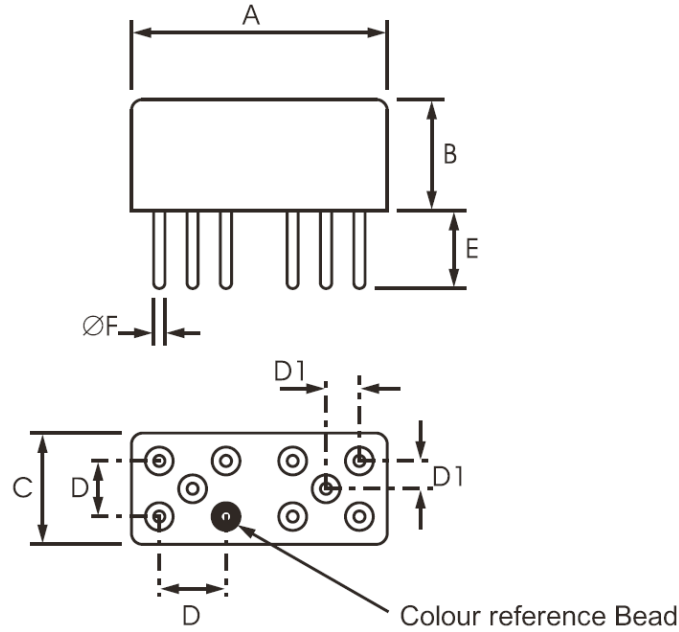

Symbols	Dimensions (mm)		Remarks
	Min	Max	
A	-	20.57	
B	-	10.41	
C	-	10.41	
D	4.95	5.21	
D1	2.4	2.7	
	5.46	6.1	Variant 10
E	6.2	6.86	Variant 09
	5.46	6.1	Variant 10
ØF	0.66	0.86	

**NOTES:**

1. Terminal identification is specified by reference to the colour reference bead. See Functional Diagram.

1.7 FUNCTIONAL DIAGRAM

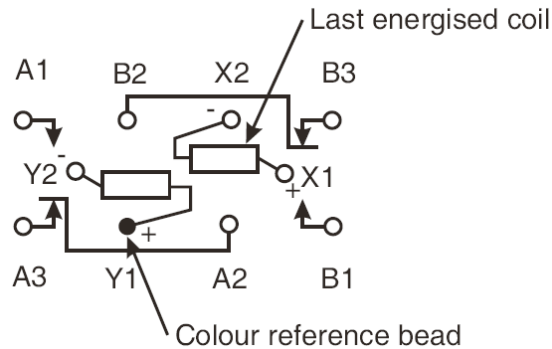

**NOTES:**

1. As viewed from the terminal side.
2. Individual terminal designations are for reference purposes only.

1.8 MATERIALS AND FINISHES

1.8.1 Case

Copper nickel, hermetically sealed. Tin-lead alloy plating may be used.

1.8.2 Terminals

The lead material and finish shall be type D3, D4, F3 or F4 in accordance with the requirements of ESCC Basic Specification No. 23500.

**2 REQUIREMENTS**

2.1 GENERAL

The complete requirements for procurement of the components specified herein are as stated in this specification and the ESCC Generic Specification. Permitted deviations from the Generic Specification, applicable to this specification only, are listed below.

Permitted deviations from the Generic Specification and this Detail Specification, formally agreed with specific Manufacturers on the basis that the alternative requirements are equivalent to the ESCC requirement and do not affect the component's reliability, are listed in the appendices attached to this specification.

2.1.1 Deviations from the Generic Specification

None.

2.2 MARKING

The marking shall be in accordance with the requirements of ESCC Basic Specification No. 21700 and as follows.

The information to be marked on the component shall be:

- (a) The ESCC qualified components symbol (for ESCC qualified components only).
- (b) The ESCC Component Number.
- (c) Traceability information.

2.3 TERMINAL STRENGTH

The test conditions for Terminal Strength, tested as specified in the ESCC Generic Specification, shall be as follows:

- (a) Pull Test
  - Applied Force: 15N

2.4 ELECTRICAL MEASUREMENTS AT ROOM, HIGH AND LOW TEMPERATURES

Electrical measurements shall be performed at room, high and low temperatures. Consolidated notes are given after the tables.

2.4.1 Room Temperature Electrical Measurements

The measurements shall be performed at  $T_{amb} = +22 \pm 3^{\circ}C$ .

Characteristics	Symbols	Test Method and Conditions	Rated Coil Voltage (Vdc)	Limits		Units
				Min	Max	
Latch Voltage	$U_L$	ESCC No. 3602 Note 1	26.5 12 6	8 4 2	13.5 6.8 3.2	V
Reset Voltage	$U_R$	ESCC No. 3602 Note 1	26.5 12 6	8 4 2	13.5 6.8 3.2	V
Latch Time	$t_L$	ESCC No. 3602	All	-	4	ms
Reset Time	$t_R$	ESCC No. 3602	All	-	4	ms
Bounce Time	$t_B$	ESCC No. 3602	All	-	2	ms
Insulation Resistance	$R_I$	ESCC No. 3602 $V_{TEST} = 100Vdc$	All	10	-	GΩ
Voltage Proof (Test Voltage)	VP	ESCC No. 3602 Maximum Leakage Current $I_{LVP} = 1mA$	All	1000 (Note 2)	-	Vrms
				500 (Note 3)	-	
Voltage Proof Leakage Current	$I_{LVP}$	ESCC No. 3602 Note 4	All	-	1	mA
Contact Voltage Drop	$V_D$	ESCC No. 3602 $I_{TEST} = 100mA$ max	All	-	$0.05 \times I_{TEST}$	V
Coil Resistance	$R_B$	ESCC No. 3602 Both Coils	26.5	810	990	Ω
			12	170	210	
			6	45	55	



2.4.2 High and Low Temperatures Electrical Measurements

Characteristics	Symbols	Test Method and Conditions	Rated Coil Voltage (Vdc)	Limits		Units
				Min	Max	
Latch Voltage	$U_L$	ESCC No. 3602 $T_{amb} = +125 (+0 -5)^{\circ}C$ and $-65 (+5 -0)^{\circ}C$ Note 1	26.5 12 6	- - -	18 9 4.5	V
Reset Voltage	$U_R$	ESCC No. 3602 $T_{amb} = +125 (+0 -5)^{\circ}C$ and $-65 (+5 -0)^{\circ}C$ Note 1	26.5 12 6	- - -	18 9 4.5	V
Latch Time	$t_L$	ESCC No. 3602 $T_{amb} = +125 (+0 -5)^{\circ}C$ and $-65 (+5 -0)^{\circ}C$	All	-	5	ms
Reset Time	$t_R$	ESCC No. 3602 $T_{amb} = +125 (+0 -5)^{\circ}C$ and $-65 (+5 -0)^{\circ}C$	All	-	5	ms
Bounce Time	$t_B$	ESCC No. 3602 $T_{amb} = +125 (+0 -5)^{\circ}C$ and $-65 (+5 -0)^{\circ}C$	All	-	2	ms
Insulation Resistance	$R_I$	ESCC No. 3602 $T_{amb} = +125 (+0 -5)^{\circ}C$ $V_{TEST} = 100Vdc$	All	100	-	M $\Omega$
Contact Voltage Drop	$V_D$	ESCC No. 3602 $T_{amb} = +125 (+0 -5)^{\circ}C$ and $-65 (+5 -0)^{\circ}C$ $I_{TEST} = 100mA$ max	All	-	$0.05 \times I_{TEST}$	V

2.4.3 Notes to Electrical Measurements Tables

1. The coil voltage rise time shall be less than  $0.1t_L$  or  $0.1t_R$ . The coil voltage shall be maintained for a minimum duration of  $10t_L$  or  $10t_R$ .
2. Points of application (1000V):
  - Between terminals (except coil) and case, coil de-energised.
  - Between terminals (except coil) and case, coil energised with Rated Coil Voltage.
  - Between coil and other terminals.
  - Between switching circuits, coil de-energised.
  - Between switching circuits, coil energised with Rated Coil Voltage.
3. Points of application (500V):
  - Between open contacts, coil de-energised.
  - Between open contacts, coil energised with Rated Coil Voltage.
  - Between coil and case.
  - Between coils.
4. Measured during Voltage Proof test.

2.5 PARAMETER DRIFT VALUES

Parameter Drift Values shall be measured as specified in the ESCC Generic Specification.

Unless otherwise specified, the measurements shall be performed at  $T_{amb} = +22 \pm 3^{\circ}C$ .

The test methods and test conditions shall be as per the corresponding test defined in Room Temperature Electrical Measurements.

The corresponding absolute limit values for each characteristic shall not be exceeded.

Characteristics	Symbols	Limits			Units
		Drift Value $\Delta$	Absolute		
			Min	Max	
Latch Voltage	$U_L$	Note 1	Note 2	Note 2	V
Reset Voltage	$U_R$	Note 1	Note 2	Note 2	V

**NOTES:**

1. Drift Value ( $\Delta$ ) limits are not specified. Drift Values shall be recorded for information purposes only.
2. The limit specified in Room Temperature Electrical Measurements shall apply.

2.6 INTERMEDIATE AND END-POINT ELECTRICAL MEASUREMENTS

Unless otherwise specified, the measurements shall be performed at  $T_{amb} = +22 \pm 3^{\circ}C$ .

Unless otherwise specified the test methods and test conditions shall be as per the corresponding test defined in Room Temperature Electrical Measurements.

Test Reference per ESCC No. 3602	Characteristics (Note 1)	Symbols	Limits		Units
			Min	Max	
Thermal Shock	<u>During 5th Cycle</u>				
	Latch Voltage	$U_L$	Note 2		V
	Reset Voltage	$U_R$	Note 2		V
	Latch Time	$t_L$	Note 2		ms
	Reset Time	$t_R$	Note 2		ms
	<u>Final Measurements</u>				
	Voltage Proof	VP	Note 3		Vrms
Voltage Proof Leakage Current	$I_{LVP}$	Note 3		mA	

Test Reference per ESCC No. 3602	Characteristics (Note 1)	Symbols	Limits		Units
			Min	Max	
Low Level Sine Vibration	<u>Final Measurements</u>				
	Latch Voltage	$U_L$	Note 3		V
	Latch Voltage Drift	$\Delta U_L/U_L$	Note 1		%
	Reset Voltage	$U_R$	Note 3		V
	Reset Voltage Drift	$\Delta U_R/U_R$	Note 1		%
Random Vibration	<u>Final Measurements</u>				
	Latch Voltage	$U_L$	Note 3		V
	Latch Voltage Drift	$\Delta U_L/U_L$	Note 1		%
	Reset Voltage	$U_R$	Note 3		V
	Reset Voltage Drift	$\Delta U_R/U_R$	Note 1		%
High Level Sine Vibration	<u>Final Measurements</u>				
	Latch Voltage	$U_L$	Note 3		V
	Latch Voltage Drift	$\Delta U_L/U_L$	Note 1		%
	Reset Voltage	$U_R$	Note 3		V
	Reset Voltage Drift	$\Delta U_R/U_R$	Note 1		%
Low Level Mechanical Shock	<u>Final Measurements</u>				
	Contact Voltage Drop	$V_D$	Note 3		V
	Latch Voltage	$U_L$	Note 3		V
	Latch Voltage Drift	$\Delta U_L/U_L$	Note 1		%
	Reset Voltage	$U_R$	Note 3		V
	Reset Voltage Drift	$\Delta U_R/U_R$	Note 1		%
	Voltage Proof	VP	Note 3		Vrms
	Voltage Proof Leakage Current	$I_{LVP}$	Note 3		mA
High Level Mechanical Shock	<u>Final Measurements</u>				
	Contact Voltage Drop	$V_D$	Note 3		V
	Latch Voltage	$U_L$	Note 3		V
	Latch Voltage Drift	$\Delta U_L/U_L$	Note 1		%
	Reset Voltage	$U_R$	Note 3		V
	Reset Voltage Drift	$\Delta U_R/U_R$	Note 1		%
	Voltage Proof	VP	Note 3		Vrms
	Voltage Proof Leakage Current	$I_{LVP}$	Note 3		mA

Test Reference per ESCC No. 3602	Characteristics (Note 1)	Symbols	Limits		Units
			Min	Max	
Resistance to Soldering Heat	<u>Final Measurements</u>				
	Insulation Resistance	$R_I$		Note 3	GΩ
	Contact Voltage Drop	$V_D$		Note 3	V
	Latch Voltage	$U_L$		Note 3	V
	Reset Voltage	$U_R$		Note 3	V
	Coil Resistance	$R_B$		Note 3	Ω
Low Level Life	<u>Final Measurements</u>				
	Contact Voltage Drop	$V_D$	-	$0.1 \times I_{TEST}$	V
	Insulation Resistance	$R_I$	5000	-	MΩ
	Voltage Proof	VP		Note 3	Vrms
	Voltage Proof Leakage Current	$I_{LVP}$		Note 3	mA
	Latch Voltage	$U_L$		Note 3	V
	Latch Voltage Drift	$\Delta U_L/U_L$		Note 1	%
	Reset Voltage	$U_R$		Note 3	V
	Reset Voltage Drift	$\Delta U_R/U_R$		Note 1	%
	Latch Time	$t_L$		Note 3	ms
	Reset Time	$t_R$		Note 3	ms
	Bounce Time	$t_B$		Note 3	ms
	Coil Resistance	$R_B$		Note 3	Ω
Resistive Life	<u>During Monitoring</u>				
	Contact Voltage Drop	$V_D$	-	2.8	V
	<u>Final Measurements</u>				
	Contact Voltage Drop	$V_D$	-	$0.1 \times I_{TEST}$	V
	Insulation Resistance	$R_I$	5000	-	MΩ
	Voltage Proof	VP		Note 3	Vrms
	Voltage Proof Leakage Current	$I_{LVP}$		Note 3	mA
	Latch Voltage	$U_L$		Note 3	V
	Latch Voltage Drift	$\Delta U_L/U_L$		Note 1	%
	Reset Voltage	$U_R$		Note 3	V
	Reset Voltage Drift	$\Delta U_R/U_R$		Note 1	%
	Latch Time	$t_L$		Note 3	ms
	Reset Time	$t_R$		Note 3	ms
	Bounce Time	$t_B$		Note 3	ms
	Coil Resistance	$R_B$		Note 3	Ω

Test Reference per ESCC No. 3602	Characteristics (Note 1)	Symbols	Limits		Units
			Min	Max	
Coil Life	<u>During Step 1 of each Cycle</u>				
	Contact Voltage Drop	$V_D$	Note 3		V
	Coil Resistance	$R_B$	Note 3		$\Omega$
	<u>During Step 3 of 1st Cycle</u>				
	Contact Voltage Drop	$V_D$	Note 2		V
	Latch Time	$t_L$	Note 2		ms
	Reset Time	$t_R$	Note 2		ms
	<u>During Steps 4 &amp; 5 of 4th Cycle</u>				
	Latch Voltage	$U_L$	Note 2		V
	Reset Voltage	$U_R$	Note 2		V
	<u>Final Measurements</u>				
	Voltage Proof	VP	Note 3		Vrms
	Voltage Proof Leakage Current	$I_{LVP}$	Note 3		mA
	Insulation Resistance	$R_I$	Note 3		G $\Omega$
	Contact Voltage Drop	$V_D$	Note 3		V
	Coil Resistance	$R_B$	Note 3		$\Omega$
	Latch Time	$t_L$	Note 3		ms
	Reset Time	$t_R$	Note 3		ms
	Bounce Time	$t_B$	Note 3		ms

Test Reference per ESCC No. 3602	Characteristics (Note 1)	Symbols	Limits		Units
			Min	Max	
Intermediate Current	<u>During Monitoring</u>				
	Contact Voltage Drop	$V_D$	-	300	mV
	<u>Final Measurements</u>				
	Insulation Resistance	$R_I$	5000	-	MΩ
	Voltage Proof	VP		Note 3	Vrms
	Voltage Proof Leakage Current	$I_{LVP}$		Note 3	mA
	Latch Voltage	$U_L$		Note 3	V
	Latch Voltage Drift	$\Delta U_L/U_L$		Note 1	%
	Reset Voltage	$U_R$		Note 3	V
	Reset Voltage Drift	$\Delta U_R/U_R$		Note 1	%
	Latch Time	$t_L$		Note 3	ms
	Reset Time	$t_R$		Note 3	ms
	Bounce Time	$t_B$		Note 3	ms
	Coil Resistance	$R_B$		Note 3	Ω
	Contact Voltage Drop	$V_D$	-	$0.1 \times I_{TEST}$	V
Overload	<u>During Monitoring</u>				
	Contact Voltage Drop	$V_D$	-	1.4	V
	<u>Final Measurements</u>				
	Contact Voltage Drop	$V_D$	-	$0.1 \times I_{TEST}$	V
	Insulation Resistance	$R_I$	5000	-	MΩ
	Voltage Proof	VP		Note 3	Vrms
	Voltage Proof Leakage Current	$I_{LVP}$		Note 3	mA
	Latch Voltage	$U_L$		Note 3	V
	Latch Voltage Drift	$\Delta U_L/U_L$		Note 1	%
	Reset Voltage	$U_R$		Note 3	V
	Reset Voltage Drift	$\Delta U_R/U_R$		Note 1	%
	Latch Time	$t_L$		Note 3	ms
	Reset Time	$t_R$		Note 3	ms
	Bounce Time	$t_B$		Note 3	ms
	Coil Resistance	$R_B$		Note 3	Ω

**NOTES:**

1. Parameter Drift shall be calculated referenced to the measurement immediately prior to the test in question. An additional initial measurement may be performed prior to the test in question if considered necessary. Drift limits are not specified. Drift Values shall be recorded for information purposes only.
2. The limits specified in High and Low Temperatures Electrical Measurements, as applicable to the same test temperature, shall apply.
3. The limits specified in Room Temperature Electrical Measurements shall apply.

2.7 **RUN-IN CONDITIONS**

The test conditions for Run-in, tested as specified in the ESCC Generic Specification, shall be as follows:

- (a) Test Temperature:  $+22 \pm 3^{\circ}\text{C}$ .

**APPENDIX A**  
**AGREED DEVIATIONS FOR LEACH INTERNATIONAL EUROPE (F)**

ITEMS AFFECTED	DESCRIPTION OF DEVIATIONS
Materials and Finishes: Terminals	For components specified with terminal finish type 3, the tin-lead plating shall have a composition of 85 to 95% tin (remainder lead).
Deviations from the Generic Specification: Qualification and Periodic Tests (Chart F4)	High Level Sine Vibration: Not Applicable
	High Level Mechanical Shock: Not Applicable
	Chart F4: Coil Life subgroup test sequence (under Endurance Subgroup 1): Coil Life and the subsequent tests shall only be performed for Qualification. They are not required for Periodic Testing except in the case of any significant change to the design.