	ESCC Detail Specification	PAGE 6
	No. 3902/003	ISSUE 1

TABLE 1(a) - TYPE VARIANTS

Variant	Z ₀ (Ω)	AWG	Inner Conductor				Insul. Wire Max. ∅ (mm)	Filler SC ∅ (mm)	Shield SC		Binder SC Nom. ∅ (mm)
			No. of Strands x ∅ (mm)	Max. ∅ (mm)	Nom. Sect. (mm ²)	Max. d.c. Resist. (Ω/km)			Constr.	Strand ∅ (mm)	
01	100	28	7x0.126	0.39	0.089	256	1.2	1.0	BS	0.079	-
02	100	26	7x0.160	0.49	0.141	159	1.4	1.0	BS	0.079	0.076

Symmetric Cable Characteristics		Filler RC ∅	Binder RC Nom. ∅	Outer Shield RC Constr.	Round Cable Characteristics Strand ∅	Bend Radius Max. ∅ Max. Weight		Min. (mm)
Max. ∅ (mm)	Max. Weight (kg/km)	(mm)	(mm)		(mm)	(mm)	(kg/km)	(mm)
2.7	12	1.0	0.076	BS	0.102	7.5	85	45
3.1	15	1.4	0.076	BS	0.102	9.0	100	60

0.076

0.102

TABLE 1(b) - MAXIMUM RATINGS

No.	Characteristics	Symbol	Maximum Ratings	Unit	Remarks
1	Operating Voltage (Continuous)	V _{op}	200	V _{rms}	-
2	Current	I	1.5 2.5	A	AWG 28 AWG 26
3	Operating Frequency	f _M	400 100	MHz Mbit/sec	10 metres. Assembly
5	Operating Temperature Range	T _{op}	-200 to +180	°C	T _{amb} Note 1
6	Storage Temperature Range	T _{stg}	-200 to +180	°C	-
7	Soldering Temperature	T _{sol}	+250	°C	Note 2

NOTES

- Precautions shall be taken such that the aggregate temperature of the datalines (ambient plus rise), due to power dissipation, does not exceed the maximum operating temperature.
- For 5 seconds maximum.

4	Data Transmission Rate	DTR		mbit/sec	Assembly
	Variant 01		100		
	Variant 02		200		

FIGURE 1 - PARAMETER DERATING INFORMATION

FIGURE 1(a) - ALLOWABLE CURRENT VERSUS TEMPERATURE

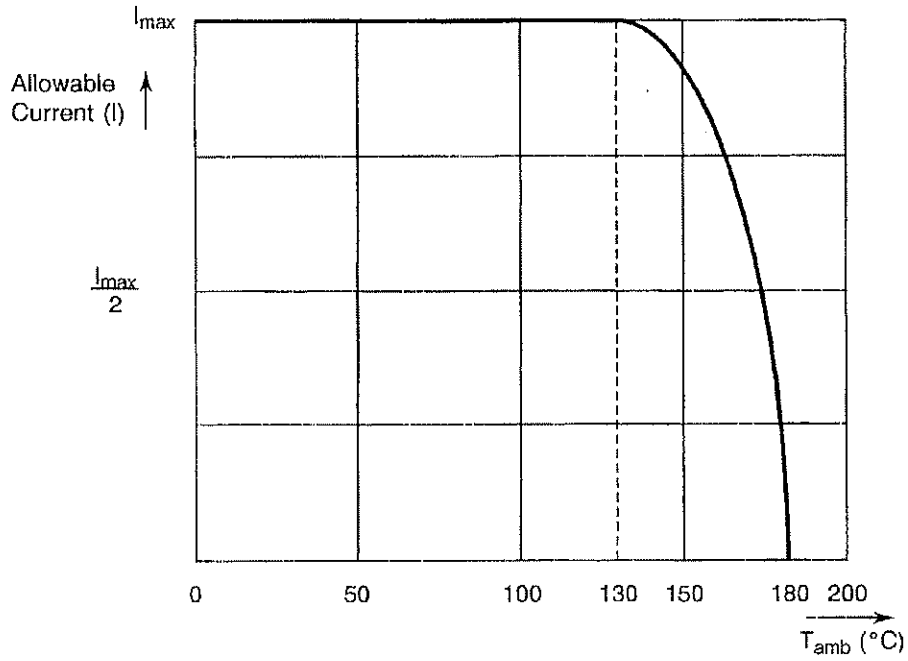
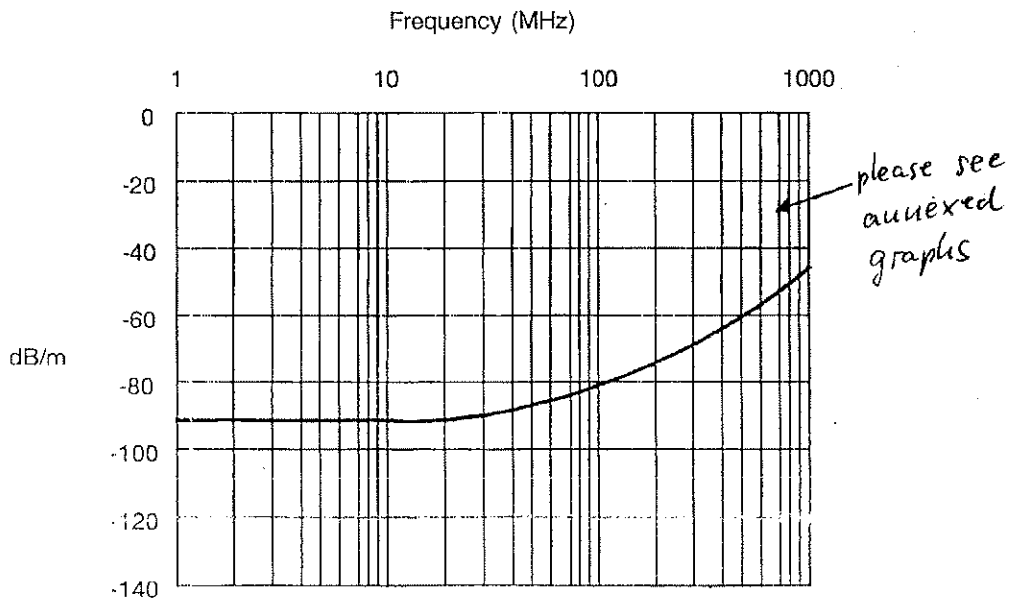

FIGURE 1(b) - MINIMUM SHIELDING EFFECTIVENESS



Construction:

Lot no.:

06.09.2006

K. Opitz

Remark:

variant 01 / AWG 28
 variant 02 / AWG 26

measured according
 to IEC 61196-1
 EN 50289-1-6

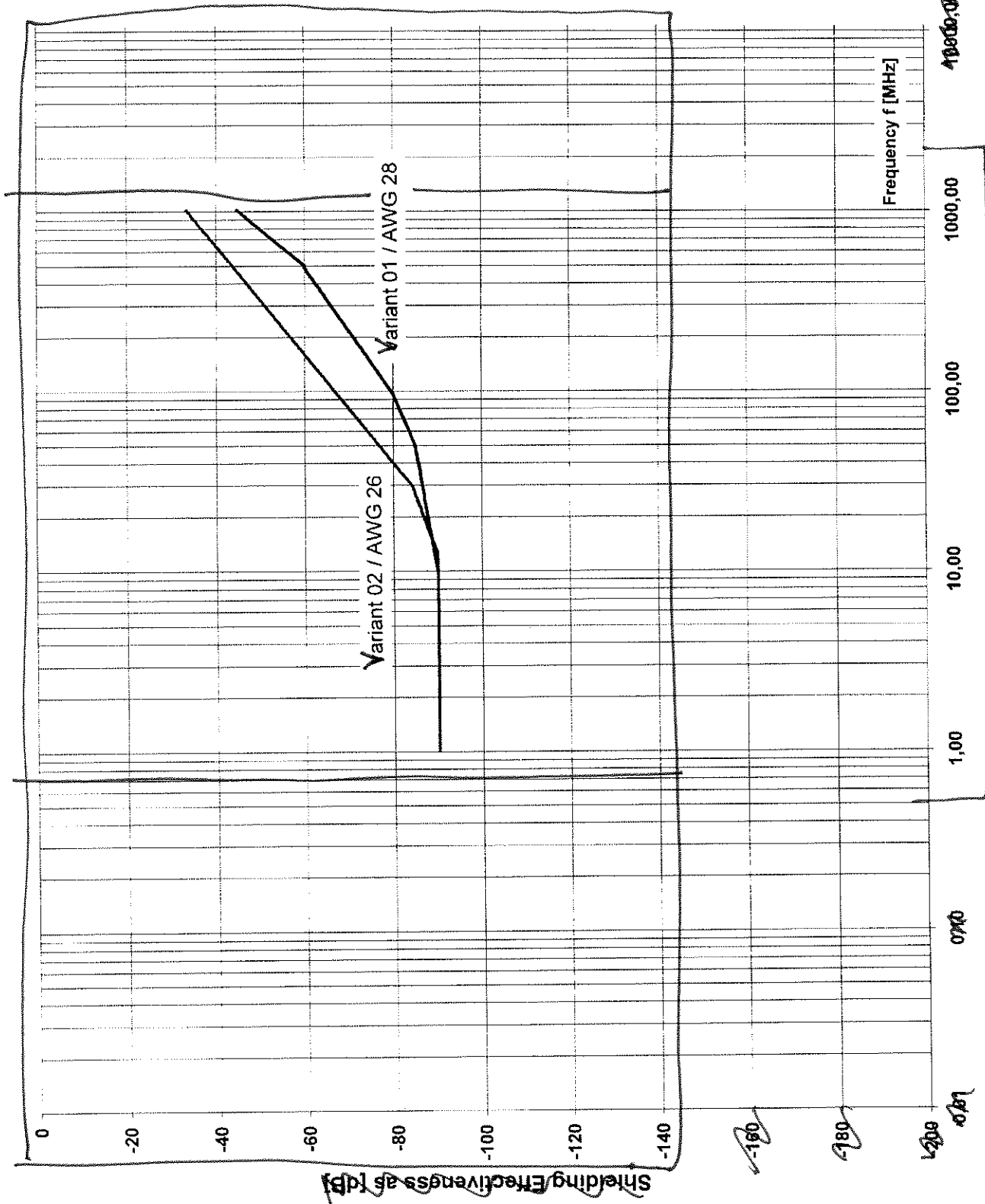
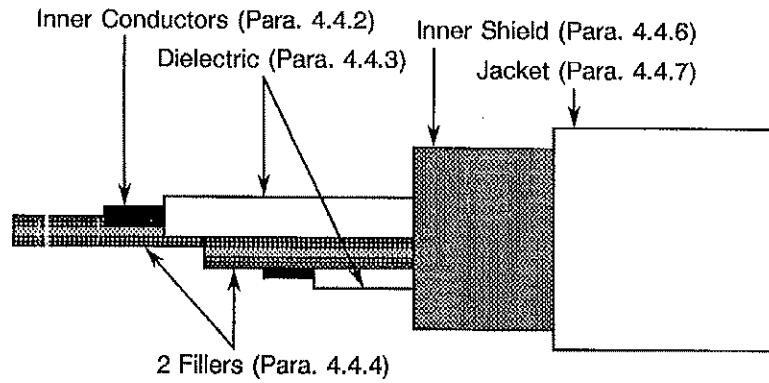

FIGURE 2 - PHYSICAL CHARACTERISTICS

FIGURE 2(a) - SINGLE SYMMETRIC CABLE - VARIANT 01



NOTES

1. See Table 1(a) for dimensions.

FIGURE 2(b) - ROUND CABLE - VARIANT 01

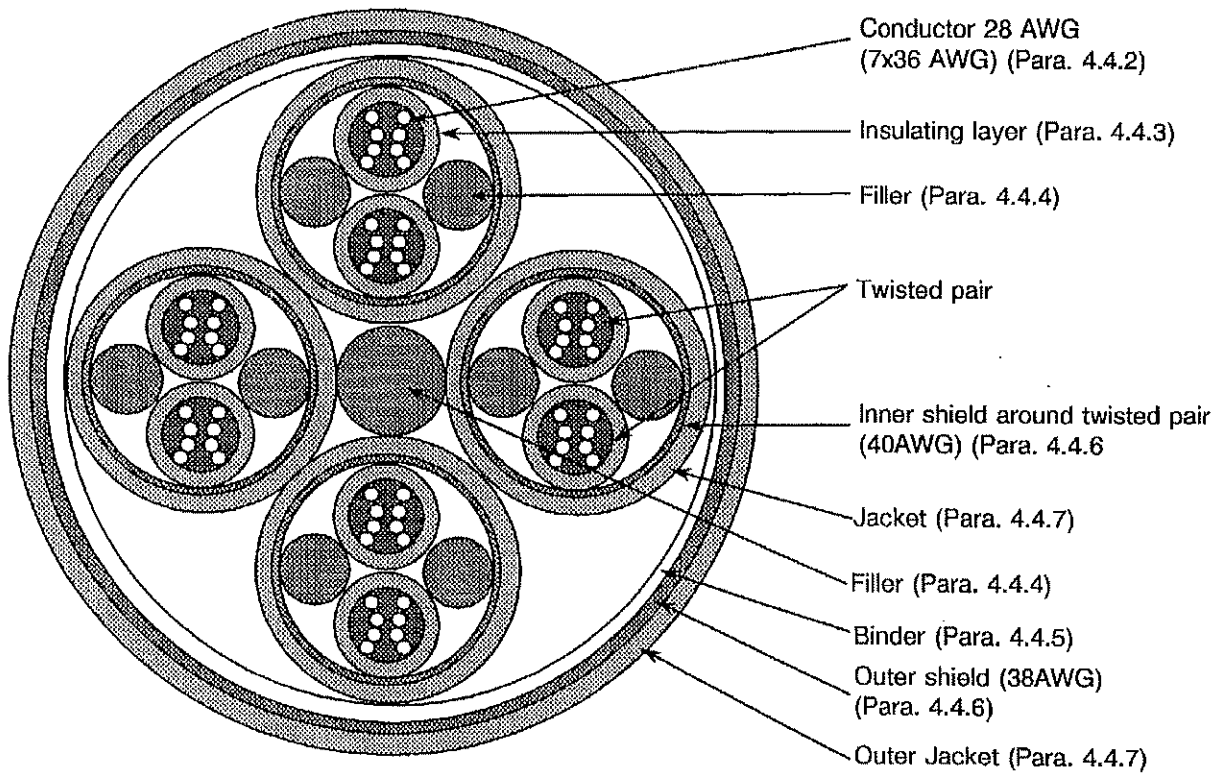
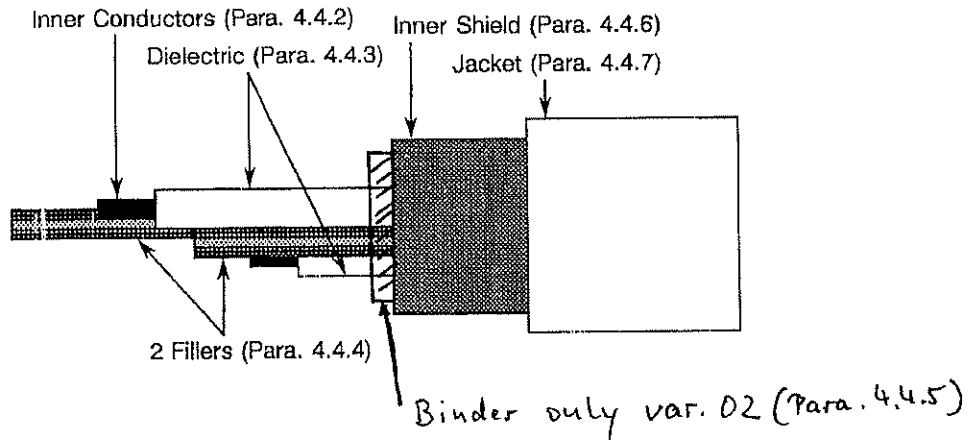

FIGURE 2 - PHYSICAL CHARACTERISTICS

(c)
FIGURE 2(a) - SINGLE SYMMETRIC CABLE - VARIANT 02



NOTES

1. See Table 1(a) for dimensions.

(d)
FIGURE 2(b) - ROUND CABLE - VARIANT 02

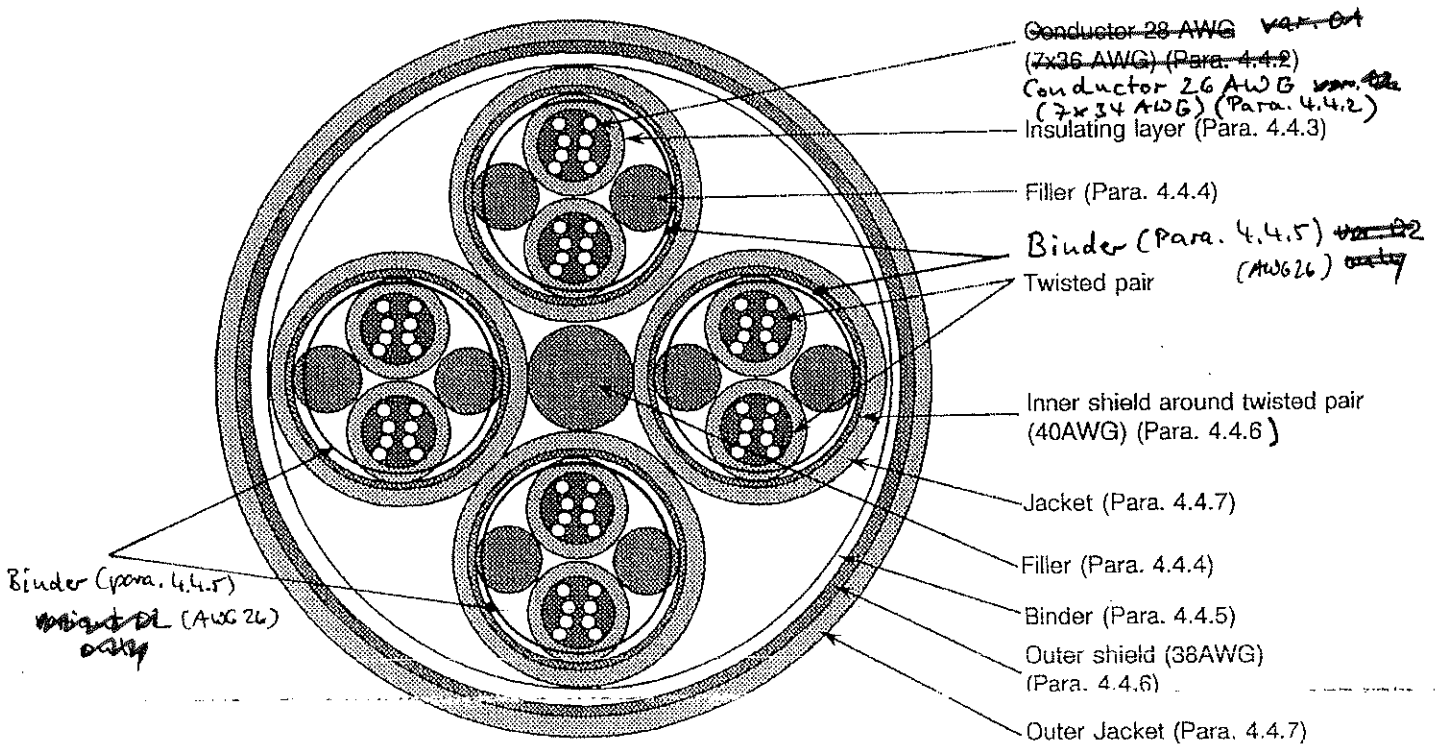



4.2.3 Deviations from Burn-in and Electrical Measurements (Chart III)

None.

4.2.4 Deviations from Qualification Tests (Chart IV)

- (a) Para. 9.7, Voltage Test: To be performed in accordance with Para. 4.8.13 of this specification.
- (b) Para. 9.10, Characteristic Impedance: To be performed in accordance with Para. 4.8.14 of this specification.
- (c) Para. 9.11, Attenuation: Shall not be performed.
- (d) Para. 9.12, Structural Return Loss: Shall not be performed.
- (e) Shielding Effectiveness: Shall be performed in accordance with Para. 4.8.17 of this specification at any point in Chart IV.

4.2.5 Deviations from Lot Acceptance Tests (Chart V)

- (a) Para. 9.11, Attenuation: Shall not be performed.
- (b) Para. 9.12, Structural Return Loss: Shall not be performed.

4.3 MECHANICAL REQUIREMENTS

4.3.1 Dimension Check

The dimensions of the datalines specified herein shall be checked. They shall conform to those shown in Table 1(a), Figure 2 and Para. 4.4 of this specification (see the Table following for list of parameters to be checked).

4.3.2 Weight

The maximum weight of the datalines specified herein shall be measured in accordance with Para. 9.2 of ESCC Generic Specification No. 3902 and shall be as specified in Table 1(a) of this specification.

4.3.3 Adhesion of the Inner Conductor

Minimum stripping force: 1.0N.

4.4 MATERIALS AND FINISHES

The materials and finishes shall be as specified herein. Where a definite material is not specified, a material which will enable the components specified herein to meet the performance requirements of this specification shall be used. Acceptance or approval of any constituent material does not guarantee acceptance of the finished product.

4.4.1 Construction of Round Cable

4.4.1.1 Generic Construction

The round cable with symmetric cables consists of four impedance controlled datalines with an overall shield and jacket. The datalines are constructed such that two conductors, each evenly centred within a dielectric, are twisted together with two fillers and then covered by a shield and jacket in accordance with Figure 2(a), *Variant 02* also includes a binder under the shield, and Figure 2(c).

4.4.1.2 Lay Length of Symmetric Cables

The lay length of all symmetric cables twisted together shall not be less than 12 times and not more than 16 times the outside diameter of the unshielded and unjacketed cable. This requirement will lead to the following lay length and/or twist per metre respectively.

Variant	Lay Length (mm)		Twists/Metre	
	Min.	Max.	Min.	Max.
01	24	32	32	41
02	27	35	29	37

4.4.1.3 Lay Length of the complete Cable

Four sets of symmetric cables twisted together shall not be less than 12 times and not more than 16 times the outside diameter of two symmetric cables. This construction shall be the core to be covered by a binder and a braided shield, i.e. outer conductor. This construction is then covered by an outermost jacket in accordance with Figure 2(b).

Variant	Lay Length (mm)	
	Min.	Max.
01	57	77
02	74	98

4.4.2 Inner Conductor

4.4.2.1 Material Characteristics

All strands used in the manufacture of the conductor shall be silver-coated high strength copper alloy.

On silver-coated strands, the thickness of silver shall be 2.0µm minimum.

For high strength copper alloy conductors, the tensile characteristics shall be not less than 6.0% in elongation and 35kg/mm² in tensile strength.

For determination of the conductor resistance at +20°C, as mentioned in Para. 9.5 of ESCC Generic Specification No. 3902, the α coefficient for copper alloy is 0.0035.

4.4.2.2 Stranding

The conductors shall be constructed of concentrically laid strands so as to produce a smooth and uniform conductor of circular cross-section and free from any high strands or other surface irregularities.

The length of lay of the external layer shall be not less than 8, nor more than 16 times the maximum conductor diameter specified in Table 1(a).

4.4.3 Dielectric

4.4.3.1 Material

Any dielectric material shall be virgin material, i.e. expanded, microporous PTFE or wrapped PTFE with only those additives that are necessary for processing and pigmentation.

Material
Expanded, microporous PTFE

4.4.3.2 Construction

The dielectric shall have a uniform cross-section throughout the length of the inner core or wire and the conductor shall be evenly centred in the dielectric.

The nominal diameter of the dielectric shall be in accordance with Table 1(a).

4.4.4 Filler

Fillers shall be used so as to ensure a smooth and uniform diameter under the shielding in order to contribute to a uniform impedance over the length of the cable.

4.4.4.1 Material

The filler material as used for the symmetric cables shall be expanded, microporous PTFE with only those additives necessary for processing.

The filler material as used for the round cable shell shall be PTFE with only the additives necessary for processing.

4.4.4.2 Construction

The filler material shall be extruded or wrapped from tapes to the diameters as given in Table 1(a).

4.4.5 Binder

~~Applicable to completed round cable only.~~

over the Binders shall be used as appropriate *the symmetric cables only variant 02* ~~over the completed round cable core.~~ *core for variant 02 only and*

4.4.5.1 Material

The material shall be virgin, wrapped, expanded, microporous PTFE with only those additives necessary for processing.

4.4.5.2 Construction

The material shall be wrapped with an overlap of 50% maximum.

4.4.6 Shield

The terms "inner shield" and "outer shield" shall be used.

1 type of shield shall be used:-

- (a) Braided Shield (BS).

	<p style="text-align: center;">ESCC Detail Specification No. 3902/003</p>	<p style="text-align: right;">PAGE 14 ISSUE 1</p>
---	---	---

4.4.6.1 Material Characteristics

All strands shall meet the requirements for silver-coated annealed copper as outlined in Para. 4.4.2.1 of this specification, but the thickness of silver shall be 2.5µm minimum.

Any strand shall show a 10% minimum elongation.

4.4.6.2 Construction

The strand size shall be as specified in Table 1(a) of this specification.

(a) Braided Shield

The braided shield type shall be of push-back type and provide not less than 90% coverage. The coverage factor K is calculated as follows:-

$$K = (2F - F^2)$$

$$F = \frac{N \times P \times d}{\sin \alpha}$$

$$\tan \alpha = 2\pi \frac{(D \times 2d) \times P}{C}$$

- K = coverage (%)
- N = number of strands.
- d = shield strand diameter (mm).
- α = angle of shield with cable axis in degrees.
- D = effective diameter of core under shield (mm).
- C = number of carriers.
- P = serving pitch/mm.

4.4.7 Jacket

The cable shall have jackets for each of the inner symmetric cables and an outer jacket for the complete round cable.

4.4.7.1 Material Characteristics

The material shall be a layer of extruded fluoropolymer PFA, with only those additives that are necessary for processing and pigmentation.

4.4.7.2 Construction

The PFA shall be extruded such that the construction underneath is centred evenly within the jacket. The wall thickness for the inner jackets shall be 0.15mm maximum, and for the outer jacket 0.25mm maximum.

4.4.8 Colours

The dielectric material, the fillers and ^{binders} ~~the jackets~~ shall be white.

The jacket colour for variant 01 shall be white.
The jacket colour for variant 02 shall be blue.



4.6.3 Circuits for Electrical Measurements

Not applicable.

4.7 BURN-IN TESTS

Not applicable.

4.8 ENVIRONMENTAL AND ENDURANCE TESTS (CHARTS IV AND V OF ESCC GENERIC SPECIFICATION NO. 3902)

4.8.1 Mechanical Properties of Conductor

As detailed in Paras. 4.4.2.1 and 4.4.6.1 of this specification.

4.8.2 Alternate Bending Resistance

The applied weights and bending diameter for alternate bending resistance are given in Table A.

Number of cycles : 500 minimum.

TABLE A - ALTERNATE BENDING RESISTANCE, LOAD AND DIAMETER

Type	Z ₀ (Ω)	Weight (kg)	Bending Diameter (mm)
RC var. 01	100	1.3	70
RC var. 02	100	1.5	90

4.8.3 Accelerated Ageing Stability

Ageing temperature : +200 ± 5 °C.
Shrinkage/Protrusion : See Table B.
Wrap Test : Mandrel diameters as per Table C.

TABLE B - SHRINKAGE/PROTRUSION

Type	Z ₀ (Ω)	Max. Shrinkage or Protrusion (mm)
RC	100	2.0

Maximum Capacitance Change : +7.0%.

4.8.4 Cold Bend Test

Chamber temperature : -80 ± 5 °C.
Mandrel diameter and load : See Table C.

TABLE C - COLD BEND TEST, MANDREL DIAMETERS AND LOADS

Type	Z ₀ (Ω)	Weight (kg)	Mandrel Diameter (mm)
RC var. 01	100	1.3	70
RC var. 02	100	1.5	90

4.8.5 Solderability

No particular conditions are applicable.

**TABLE 2 - ELECTRICAL MEASUREMENTS AT ROOM TEMPERATURE
ROUND CABLES**

Type	ESCC Gen. Spec. No. 3902						
	Para. 9.6	Para. 9.6	Para. 9.7	Para. 9.9		Para. 9.10	Para. 9.20
	No. 1	No. 2	No. 3	No. 4		No. 5	No. 6
	Characteristic Diel. Strength of Inner Jacket (kVac)	Characteristic Diel. Strength of Outer Jacket (kVac)	Characteristic Voltage Test (Diel. Core) (kVdc)	Characteristic Capacitance (Max.) (pF/m)		Characteristic Impedance (Ω)	Characteristic Corona Extinction Voltage (Vac)
Cond. - Cond.				Cond. - Shield			
RC var. 01	1.5	2.0	1.4	50	90	100 ± 6	500
RC var. 02	1.5	2.0	1.4	45	75	100 ± 6	500

No.	Characteristic	ESCC Gen. 3902	This Specification	Limits
7	Inner Conductor Resistance	Para. 9.5	-	See Table 1(a)
8	Insulation Resistance	Para. 9.8	-	5000MΩ × km
9	Shielding Effectiveness	-	Para. 4.8.17	See Figure 1(b)

SYMMETRIC CABLES

This Specification		
Para. 4.8.18	Para. 4.8.19	Para. 4.8.19
No. 10	No. 11	No. 12
Characteristic Time Delay (Max.) (nsec/m)	Characteristic Conductor Time Delay Difference (Max.) (nsec/m) Per Pair	Characteristic Conductor Time Delay Difference (Max.) (nsec/m) Pair to Pair
4.3	0.08	0.13